

Installation manual

NORTON: POL_90

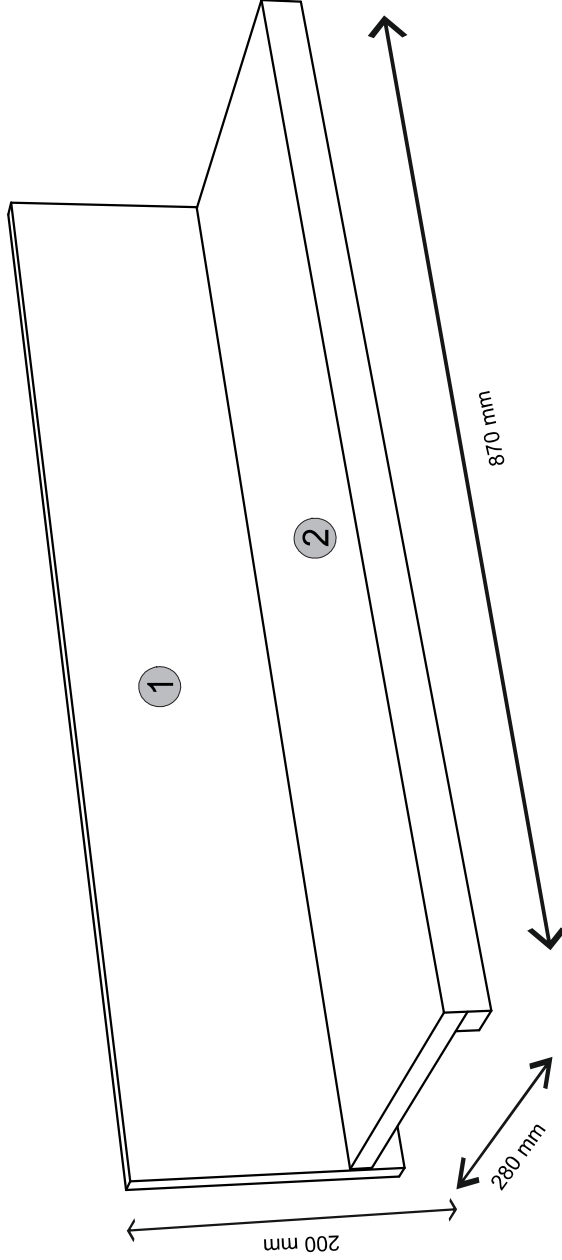

Element symbol	Dimensions		Code	Package		
1	870	200	16	1	K-101	1/1
2	868	204	16\32	1	K-301	1/1

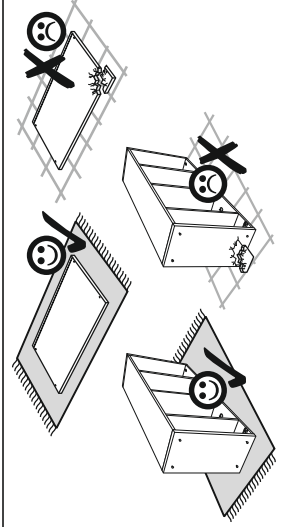
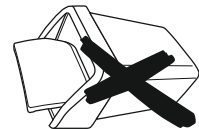
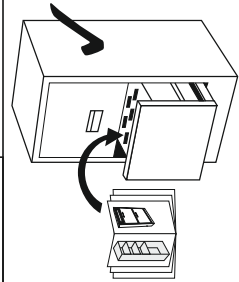
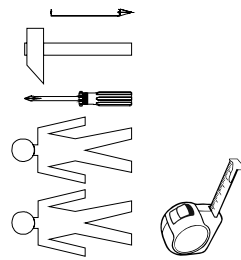
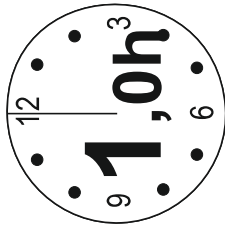
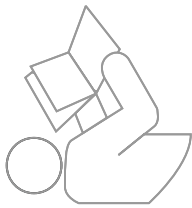
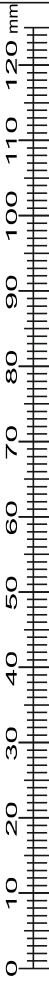
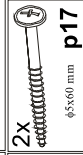
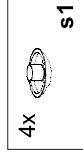
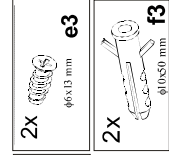
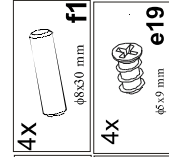
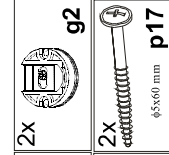
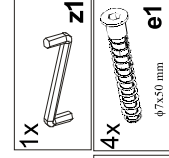
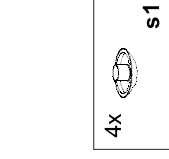

1

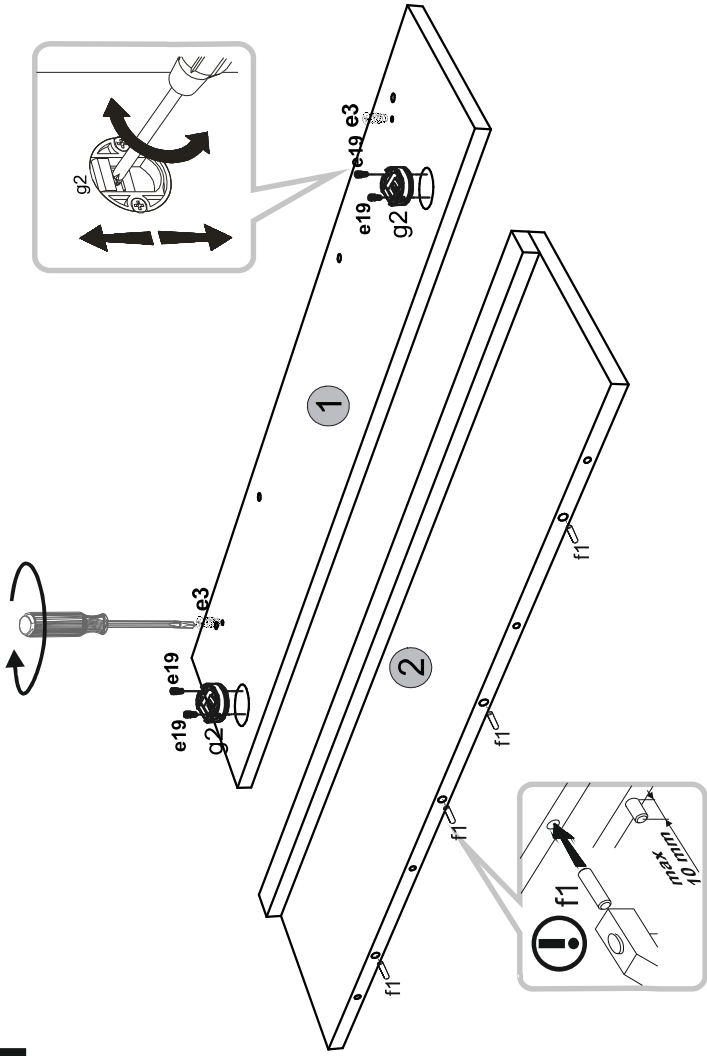

2

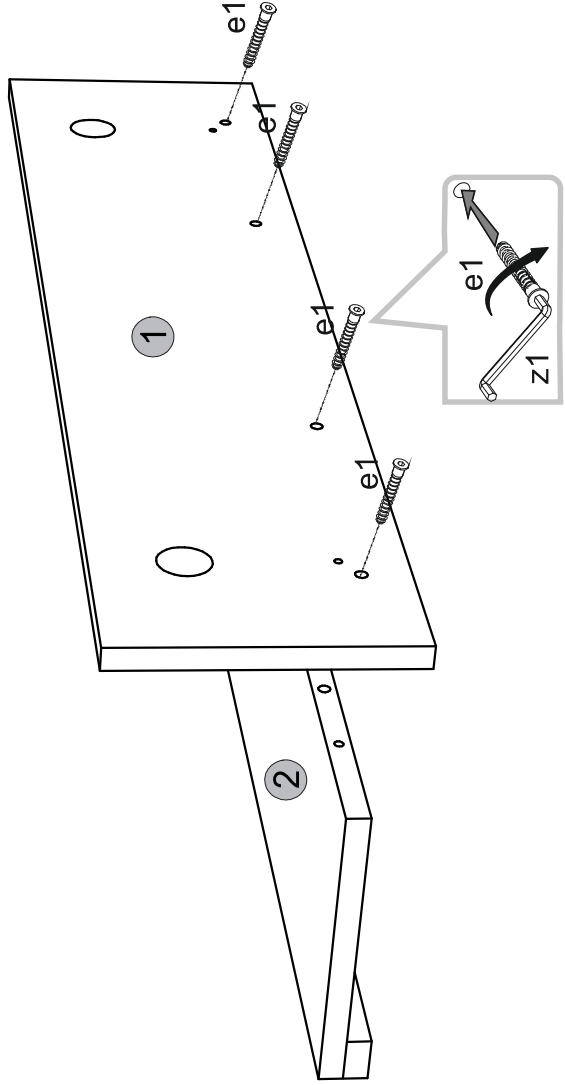

3

