

COUNTRY

9X--CT 63

1 / 7

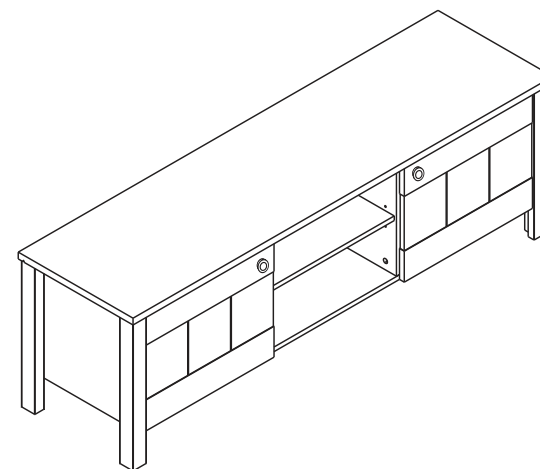
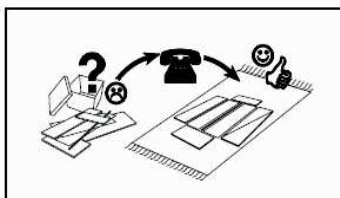
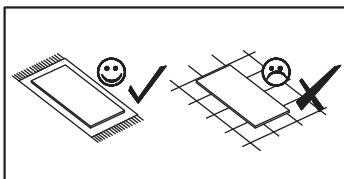
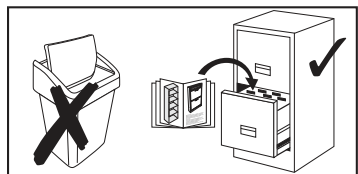
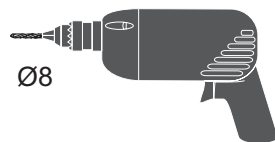
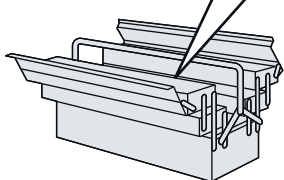
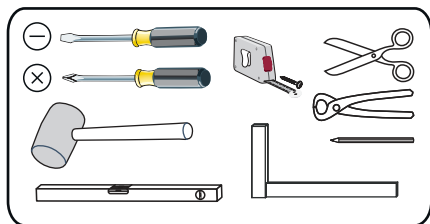
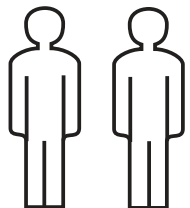

B - 1569mm  
H - 509mm  
T - 429mm

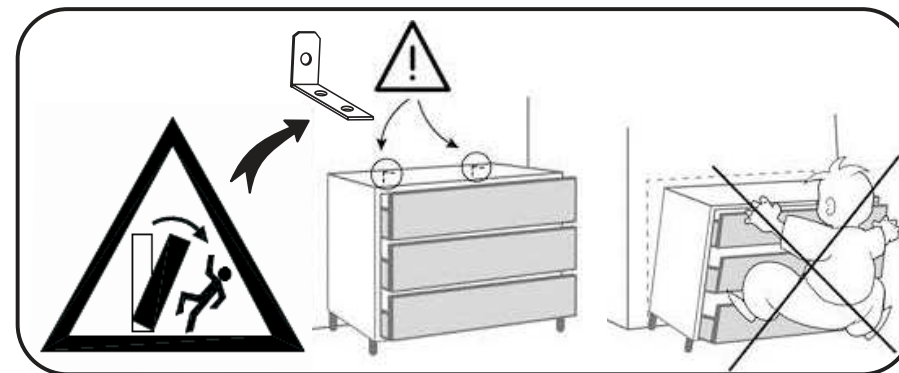
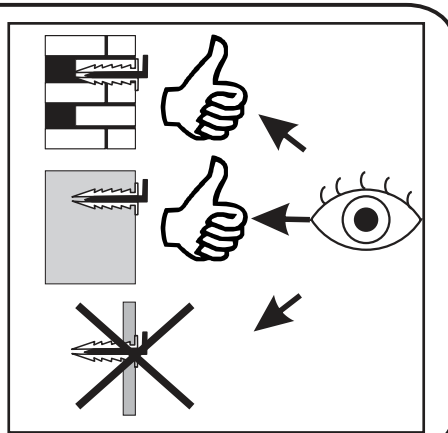
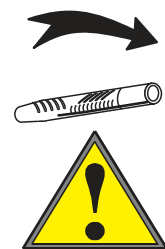
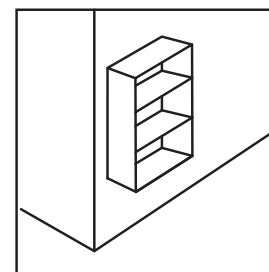
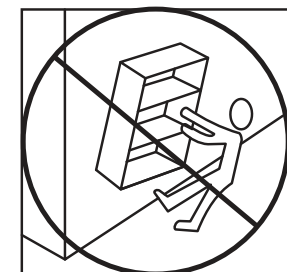
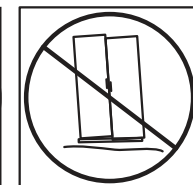
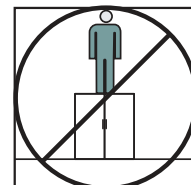
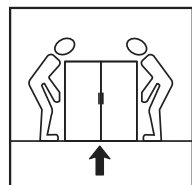
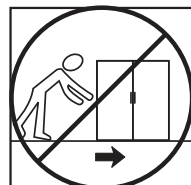

B - 1569mm  
 H - 509mm  
 T - 429mm

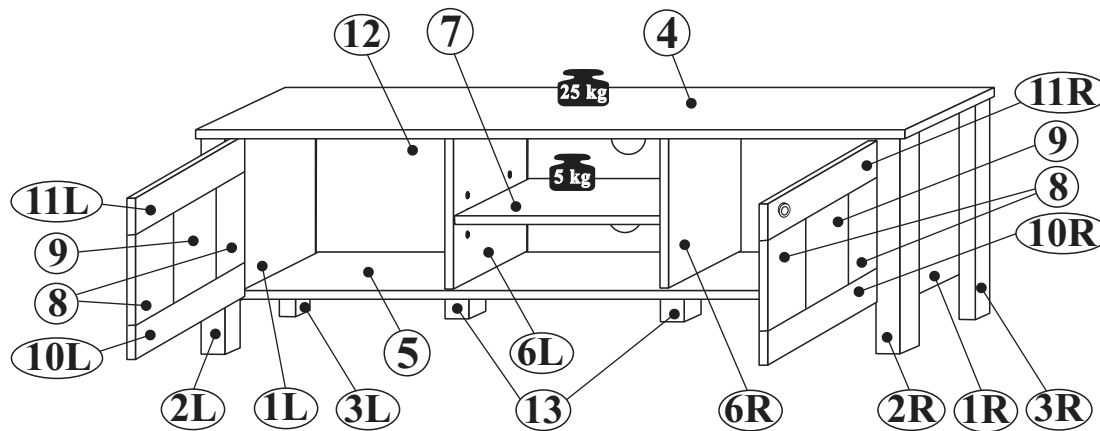
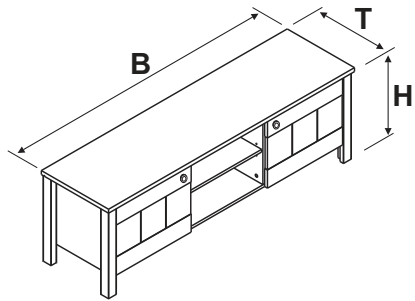

**NR 1**

**(B1)**  $\phi$  8x28 x16

**(B3)**  $\phi$  6x45 x24

**(M1)** x16+8

**(T1)** x16+8

**(K9)** 7x35 x12

**(K1)**  $\phi$  7x50 mm x2

**(S4)** 3,0x20 x6

---

**NR 2**

**(C14)**  $\phi$ 20mm x20

**(J23)** x16

**(W1)** x4

**(F15)** x6

**(G7)** S4 x1

**NR 4**

**(Y1)** Kr15 x4

**(D7)** H4 x4

**(S8)** 4x13 x8

**(E3)** 6,3x13 x8

---

**NR 5**

**(U61)** x2

**(A14)** M4x23 x2

---





**NR 6**

**(J11)** x2

**(P13)** 3,5x13 mm x4



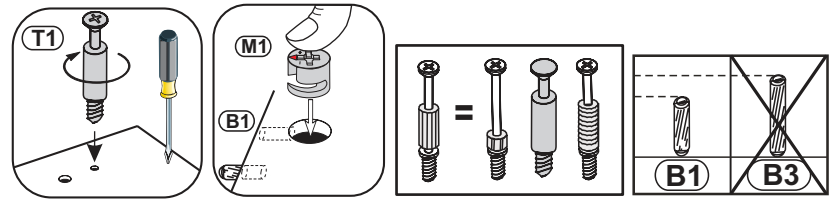
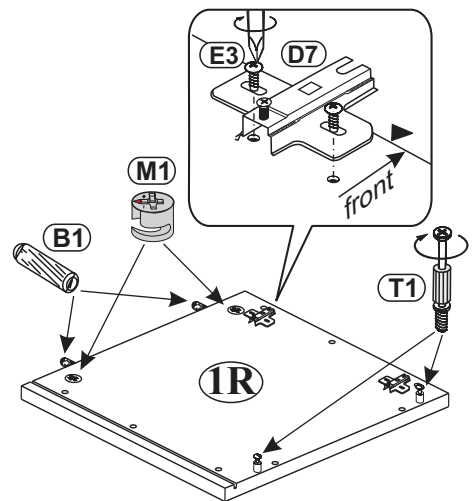
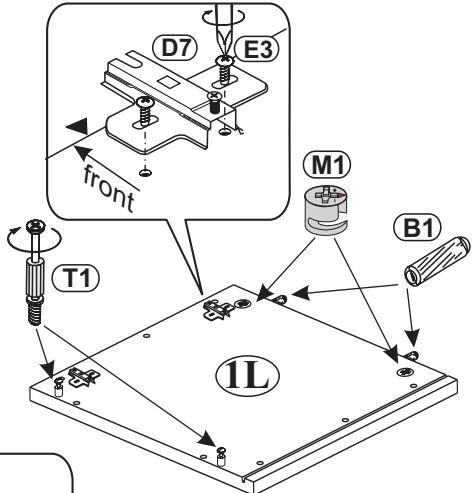
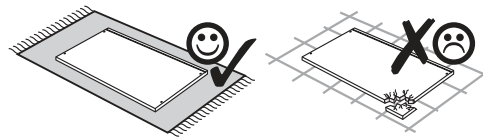

1

- B1**   $\phi$  8x28 x4
- M1**  x4
- T1**  x4
- D7**  H4 x4
- E3**  6,3x13 x8



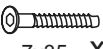

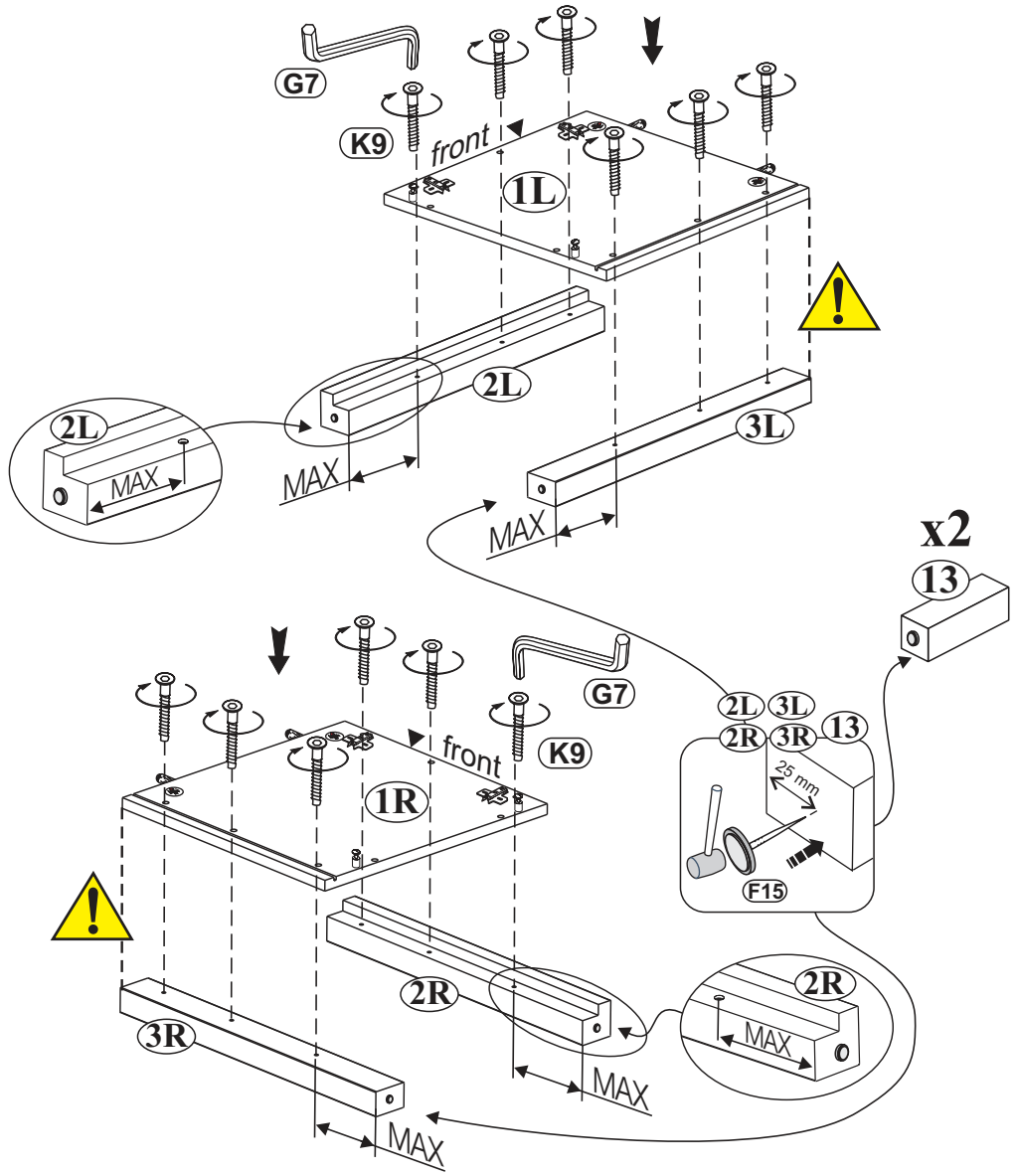

2

- K9**  7x35 x12
- F15**  x6
- G7**  S4 x1



3

- B1**   $\phi$  8x28 x12
- M1**  x12
- T1**  x12
- W1**  x4
- K1**   $\phi$  7x50 mm x2

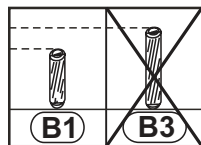
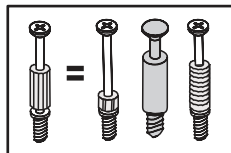
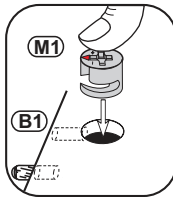
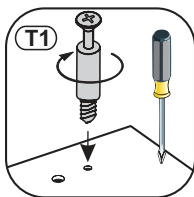
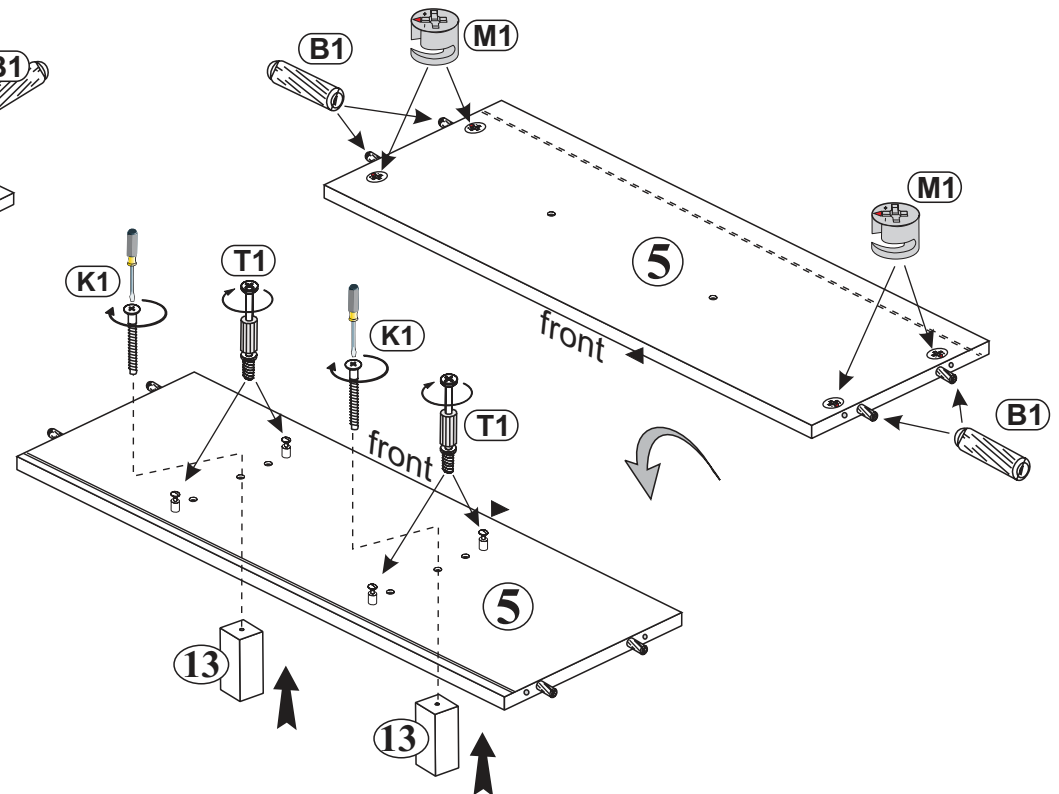
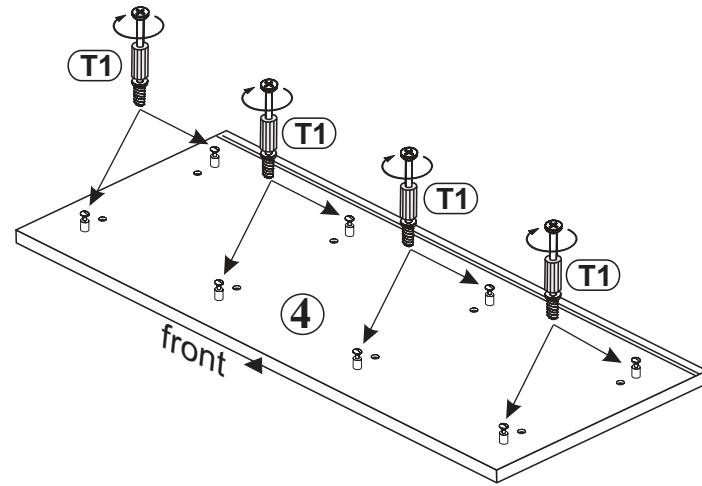
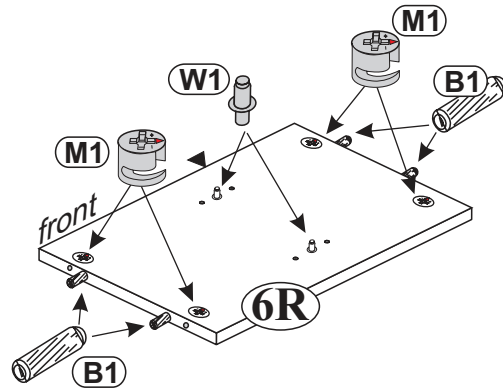
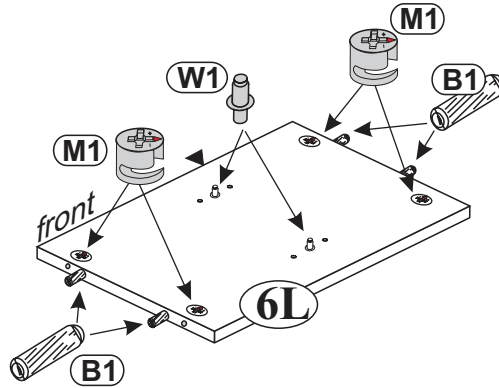

4

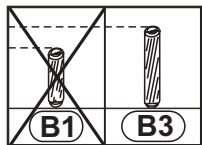
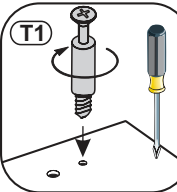
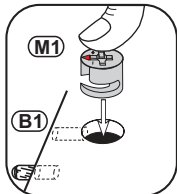
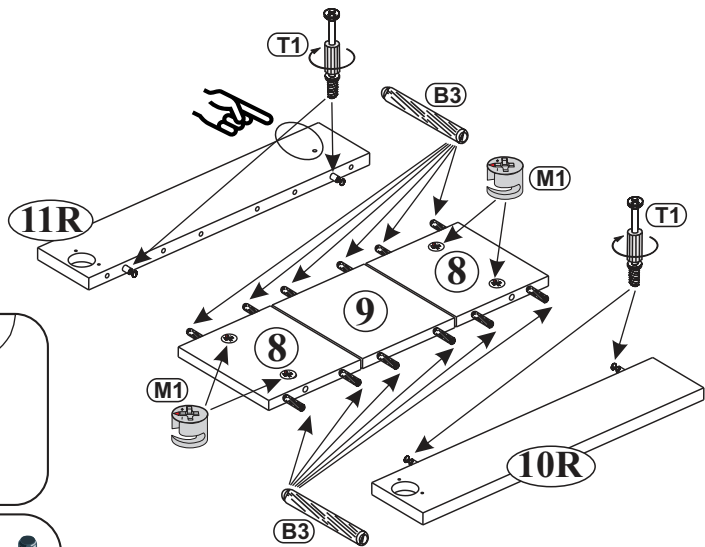
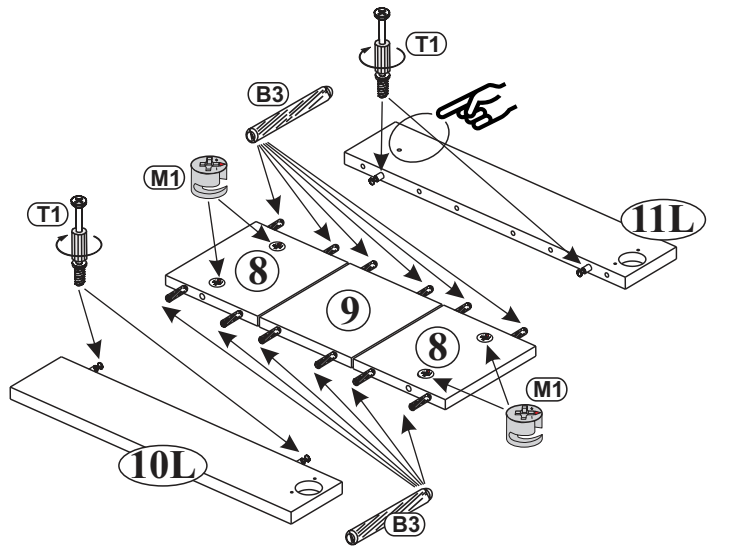
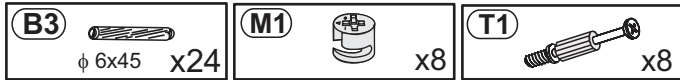

5

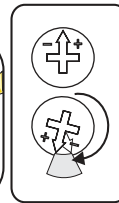
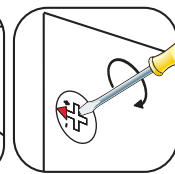
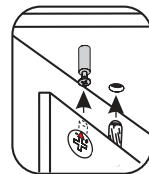
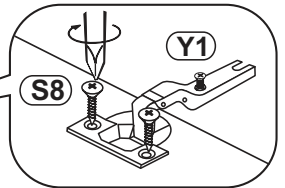
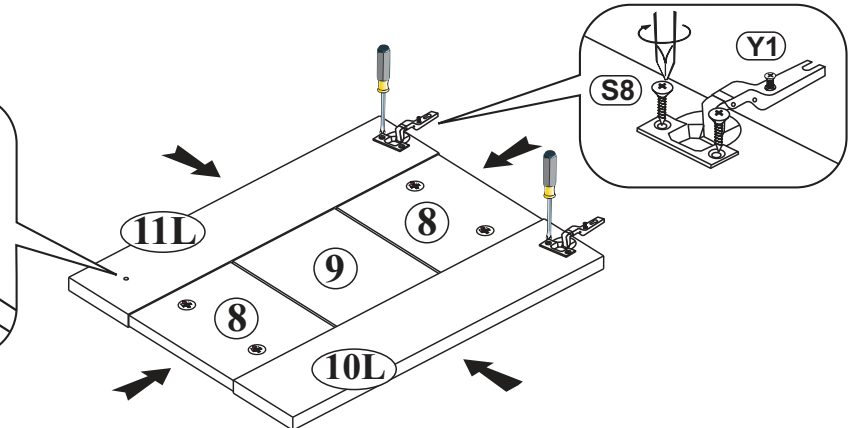
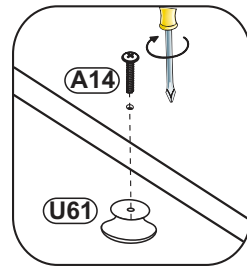
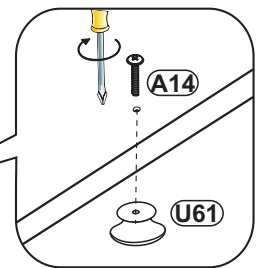
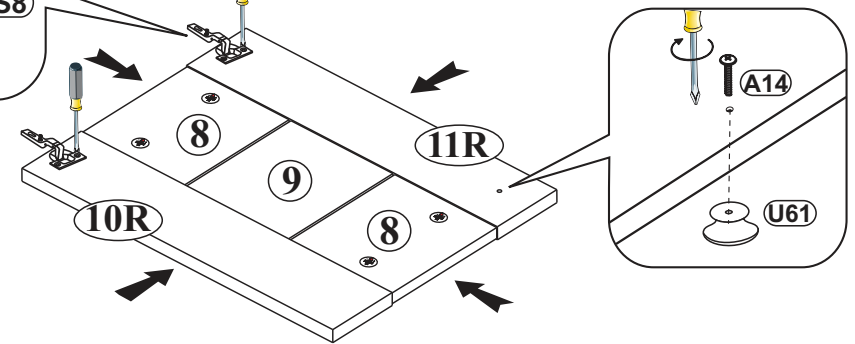
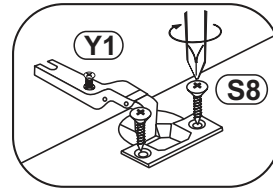
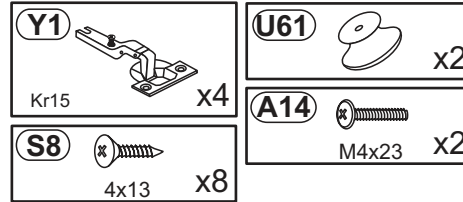

6

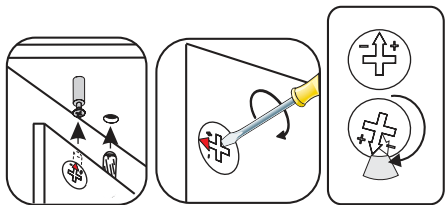
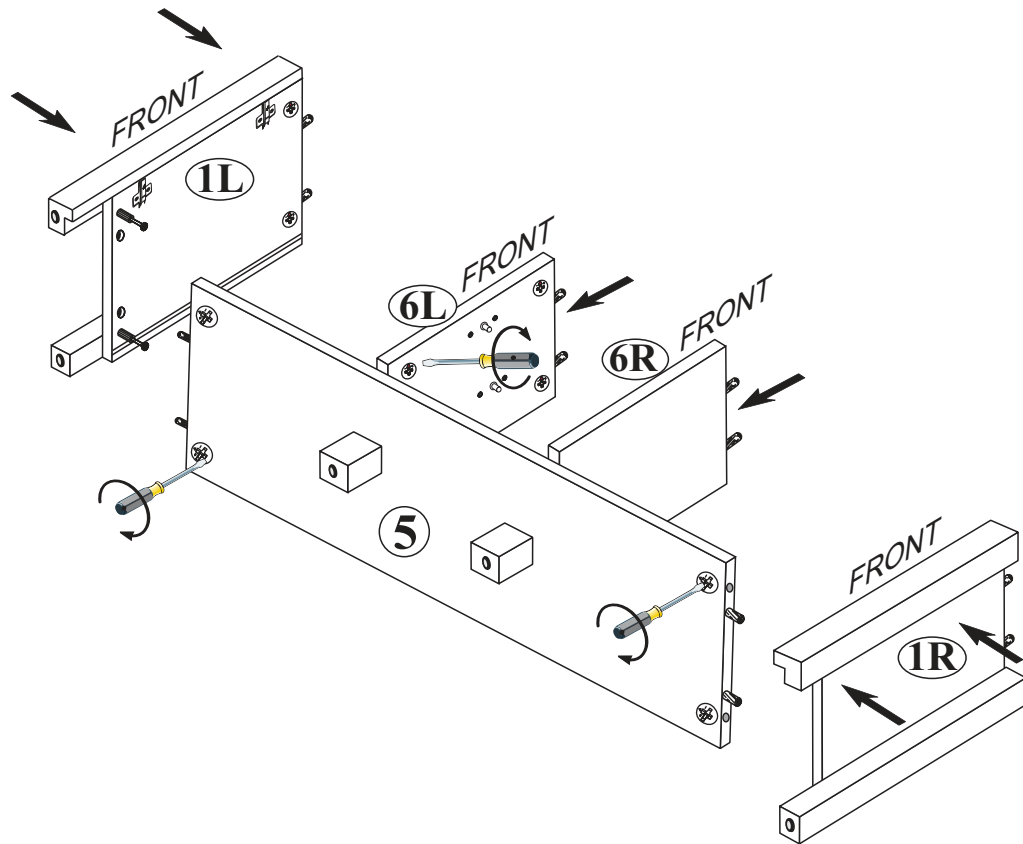

7

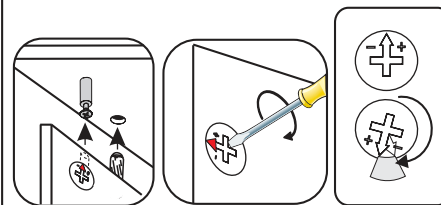
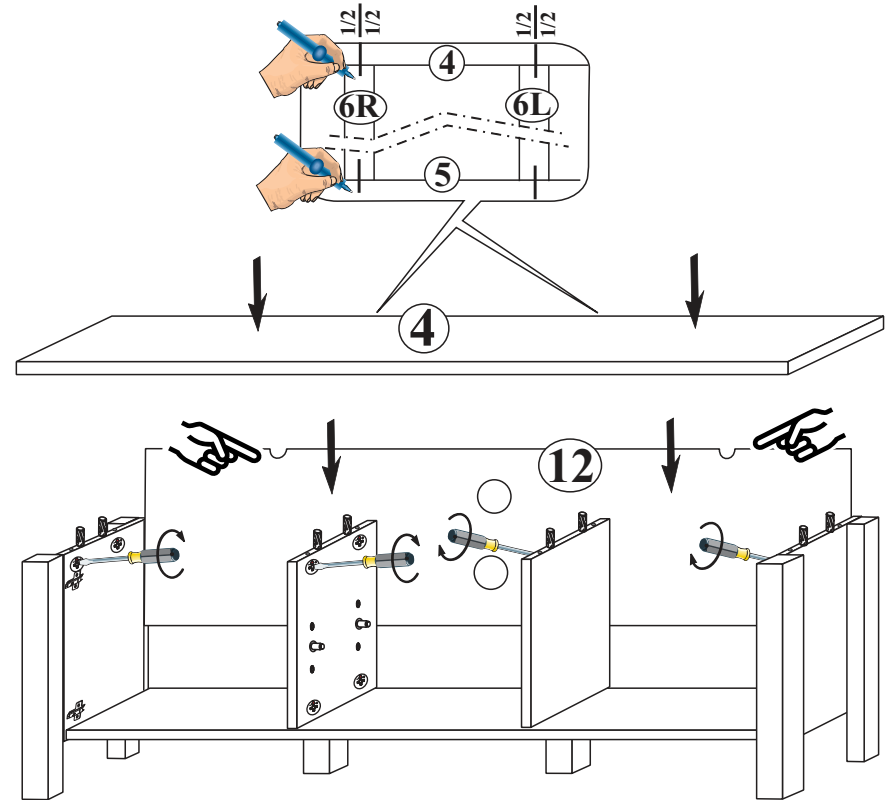

8

- S4** 3,0x20 x6
- J23** x16

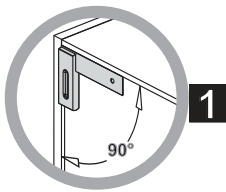
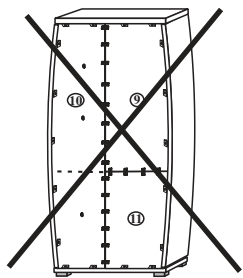
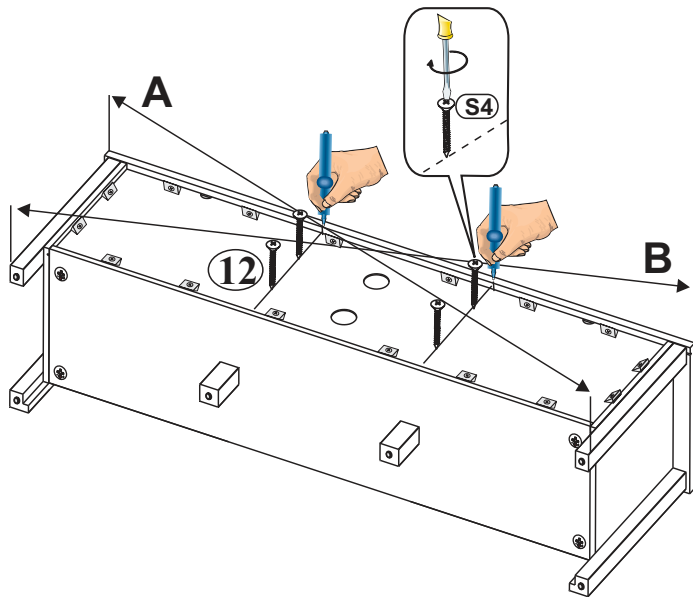

A=B

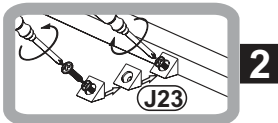

9

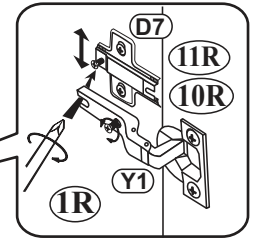
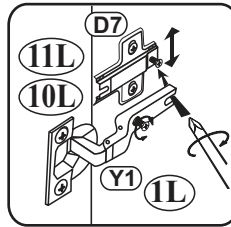
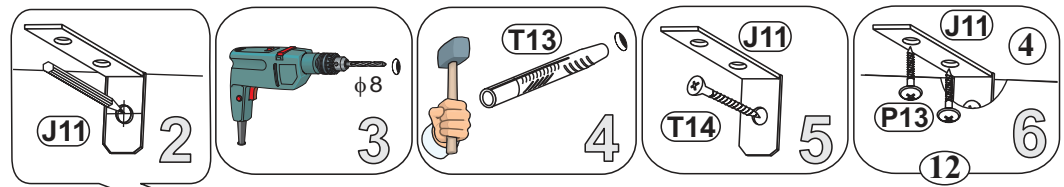

- J11** x2
- P13** 3,5x13 mm X4
- C14** φ20mm x20

