

ACURO II (GDC0084Aa-4)

1

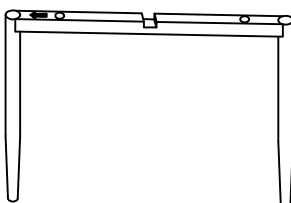

2



3

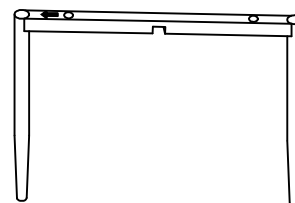

1	1X
2	1X
3	1X

A

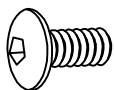

M6x16mm
4X

B

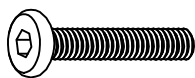

M6x40mm
4X

C



Ø16xØ6x1.5mm
4X

D

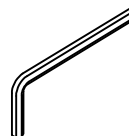

5MM
1X

E

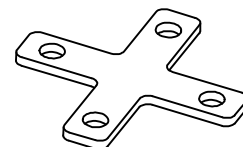

15x85x85
1X

1

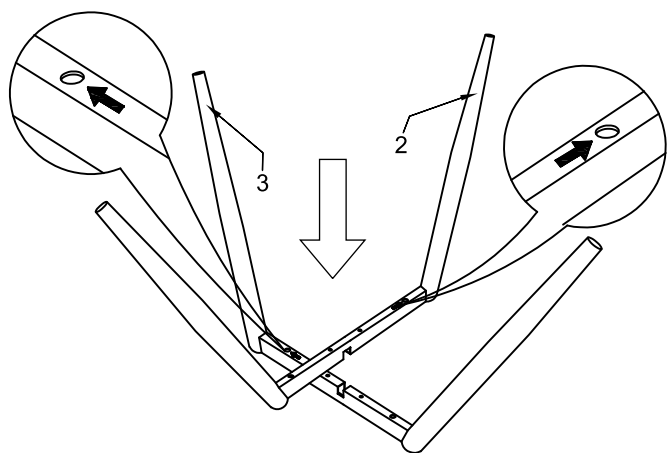

2

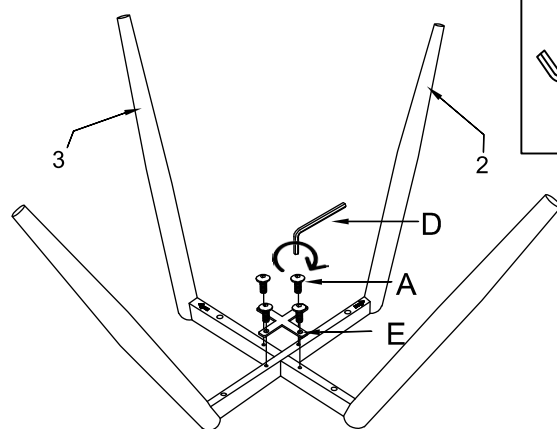

3

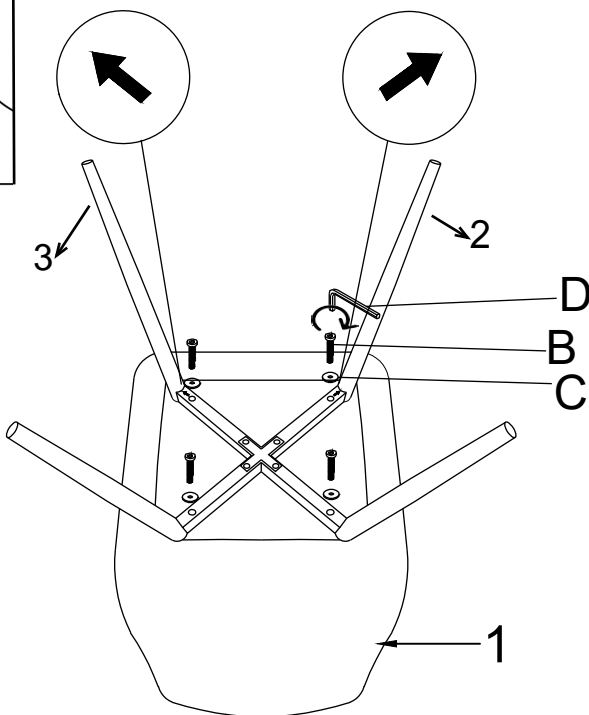
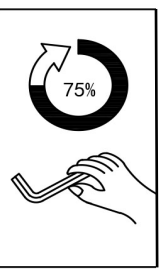

4

