

COUNTRY

9X--CT 01

1 / 9

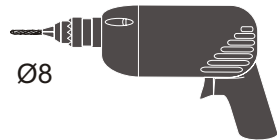
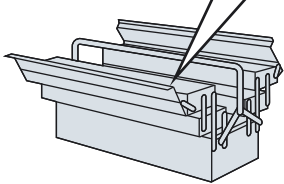
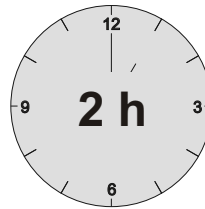
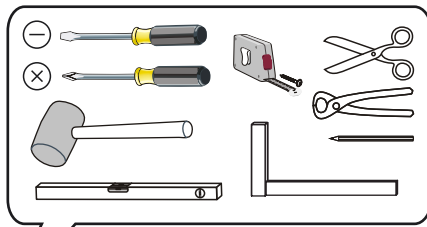
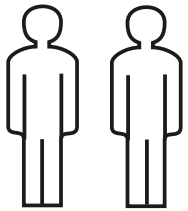

B - 604mm
H - 1912mm
T - 429mm

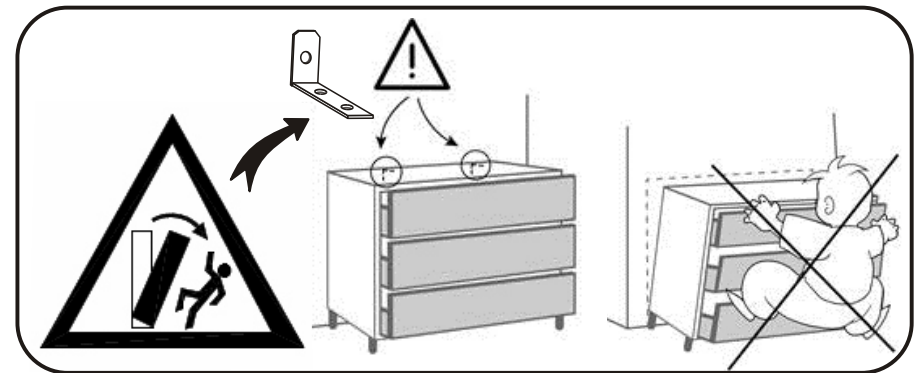
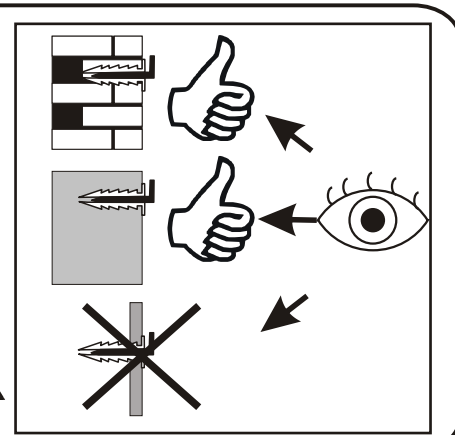
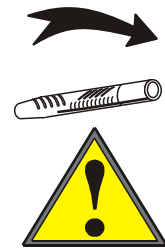
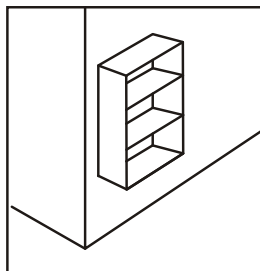
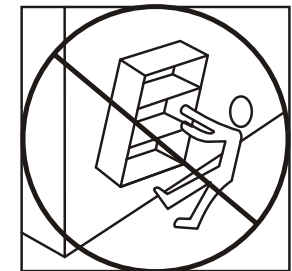
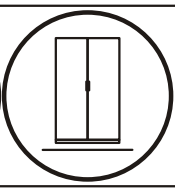
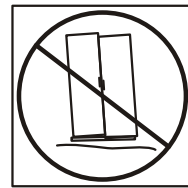
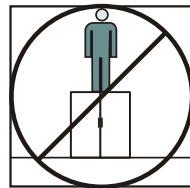
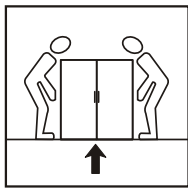
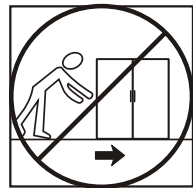
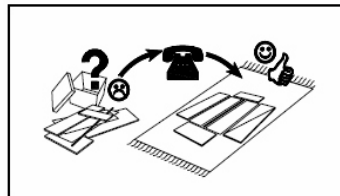
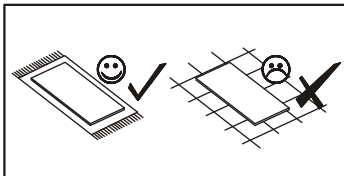
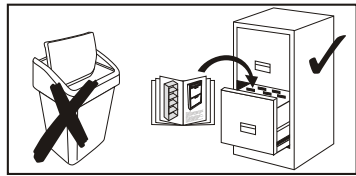
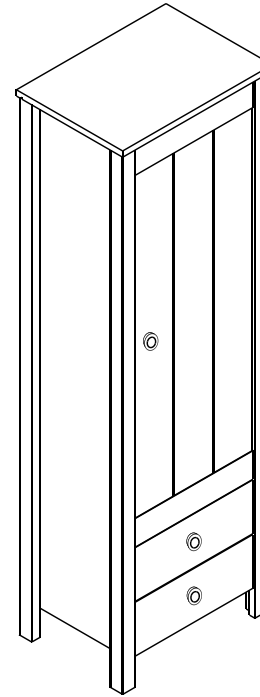

B - 604mm
H - 1912mm
T - 429mm

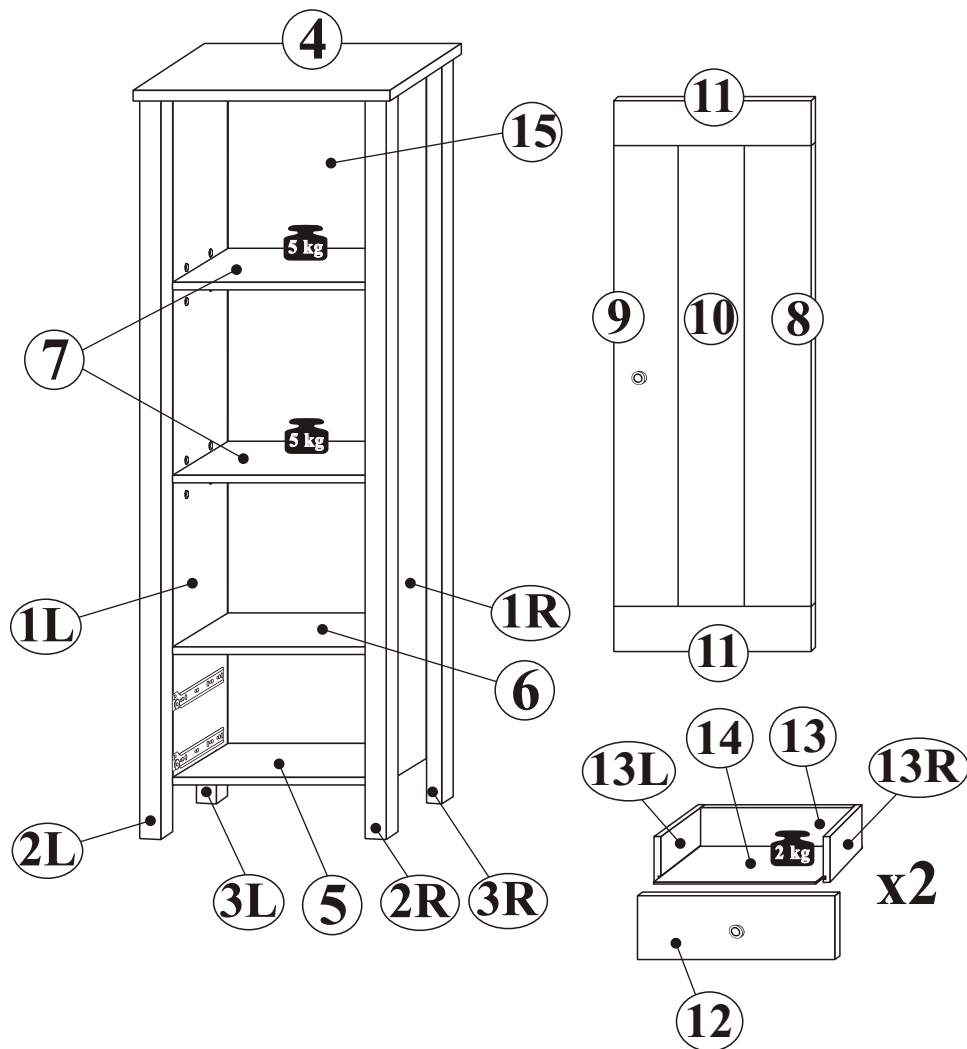
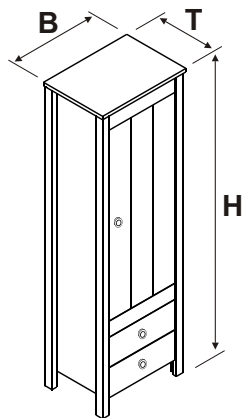

NR 1

B1 8x28 x12

B3 6x45 x12

M1 x12+4

T1 x12+4

K9 7x35 x20

NR 2

C14 mm x8

J23 x24

W1 x8

S4 3,0x20 x3

F15 x4

G7 S4 x1

NR 3

R22 L-350 mm

x2L/2R

E2 6x11 x12

P3 3x13mm x8

S3 3,5x13 x4

M2 12x10mm x4

T2 5x35mm x4

P5 4x30 x8

NR 4

Y1 Kr15 x4

D7 H4 x4

S8 4x13 x8

E3 6,3x13 x8

NR 5

U61 x3

A14 M4x23 x3







NR 6

J11 x1

P13 3,5x13 mm x2

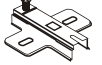

1

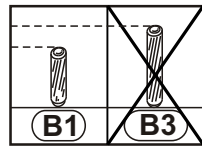
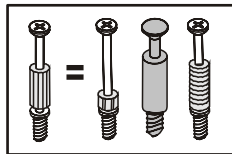
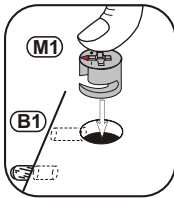
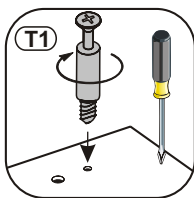
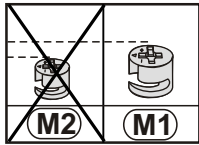
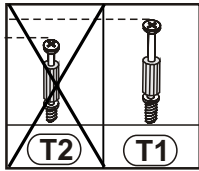
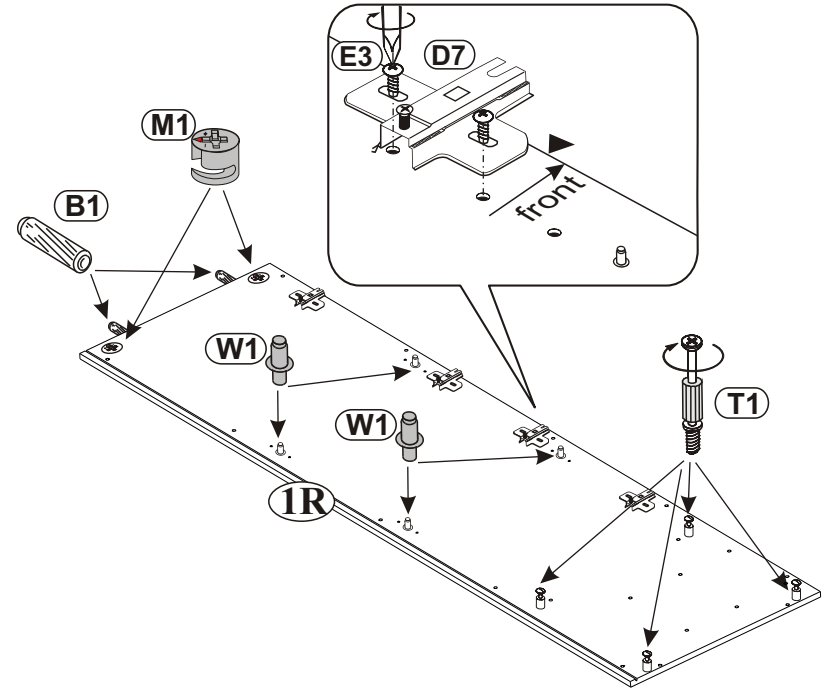
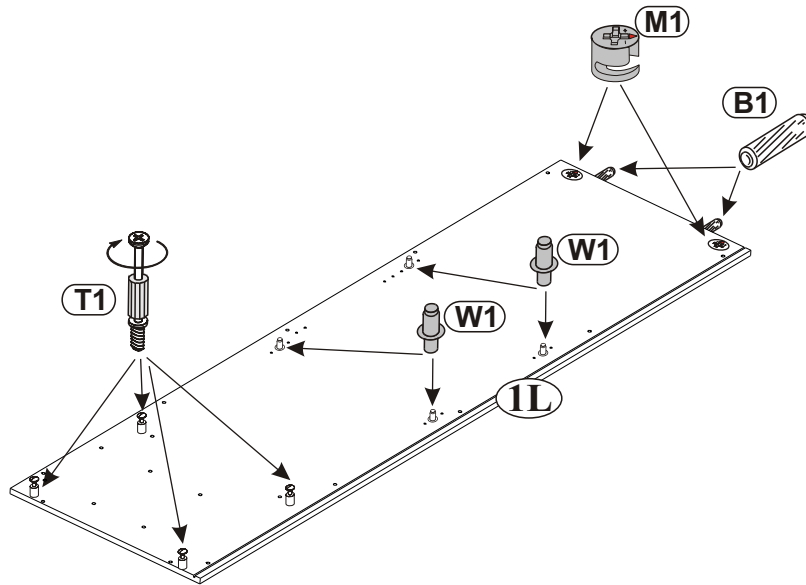
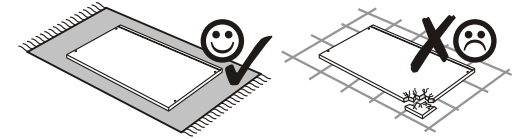

M1  x4	B1  8x28 x4	E3  6,3x13 x8
T1  x8	D7 H4  x4	W1  x8

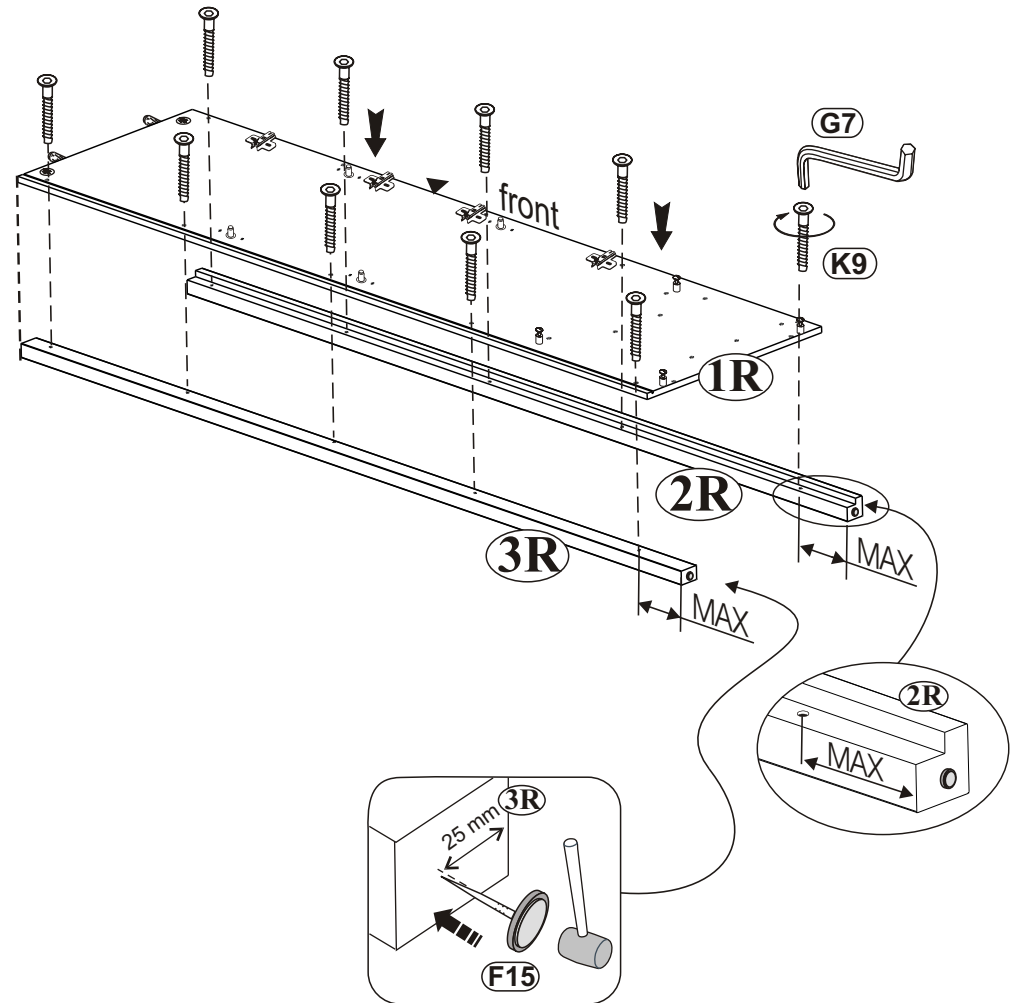
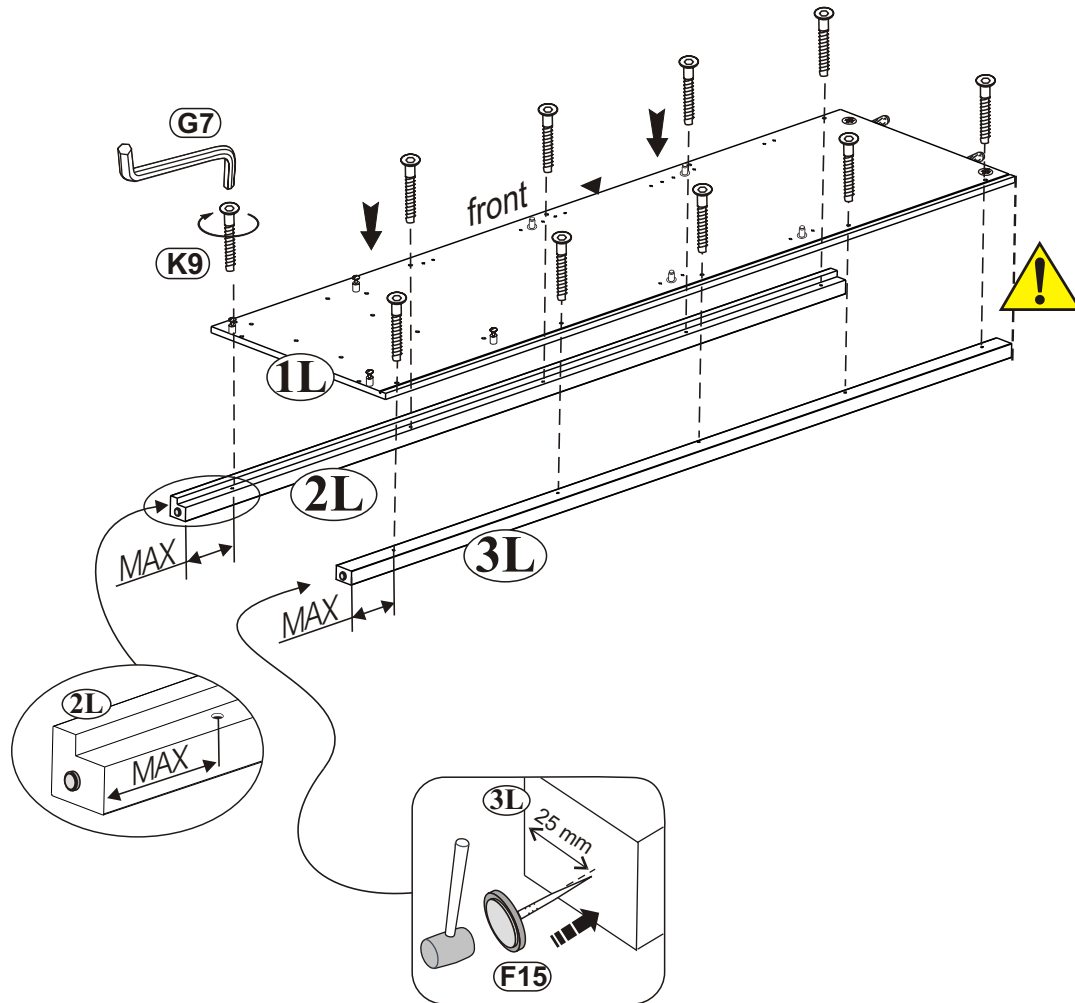
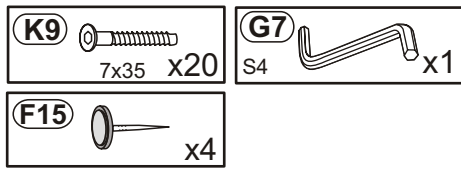

2



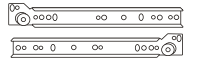

3

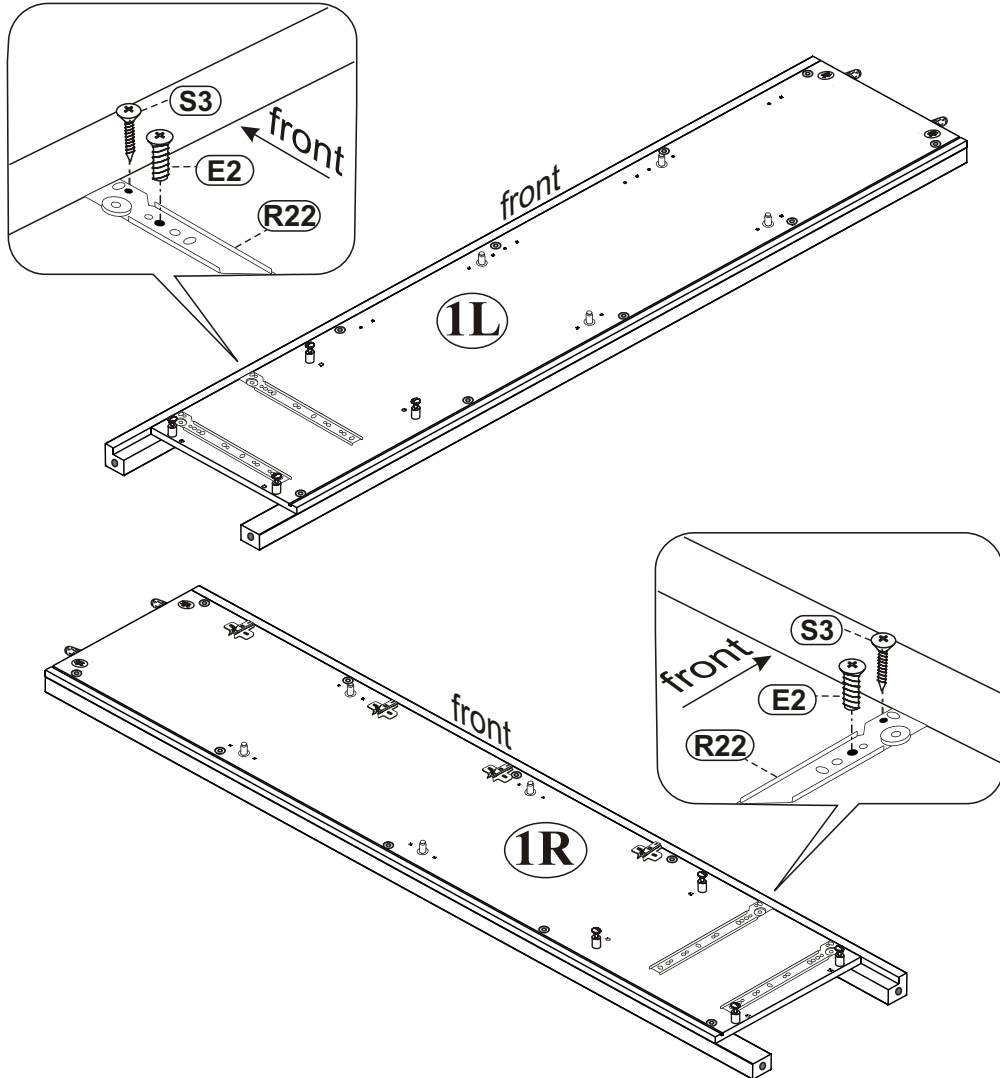
- | | | | | | |
|---|----------|-----------|---|--------|-----|
| R22 | L-350 mm | E2 |  | 6x11 | x12 |
|  | | S3 |  | 3,5x13 | x4 |
| | x2L/2R | | | | |





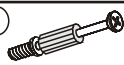

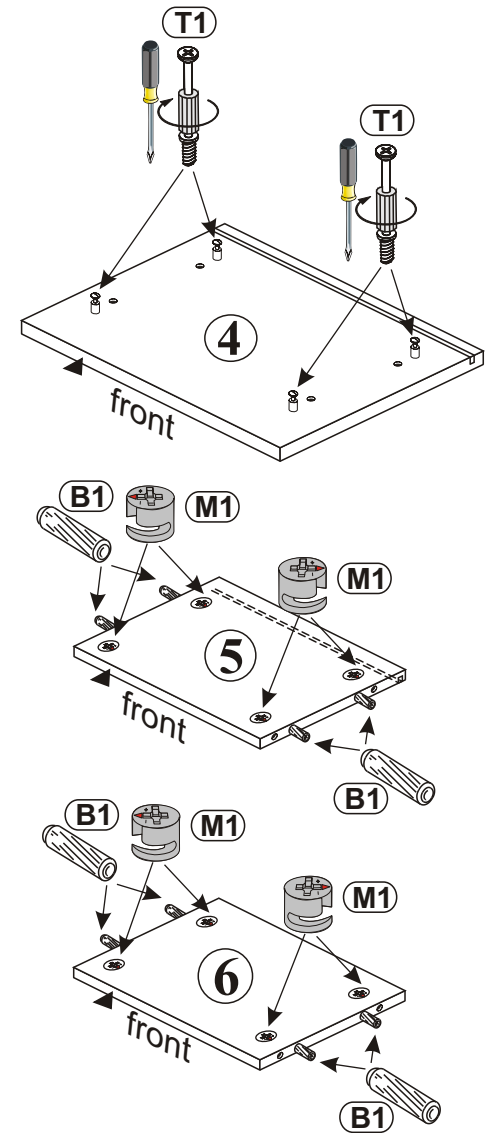
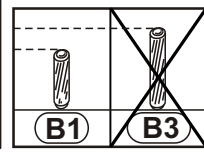
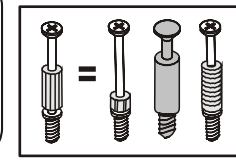
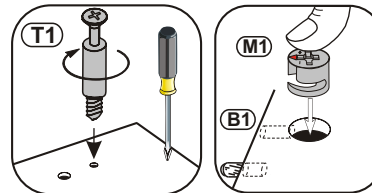
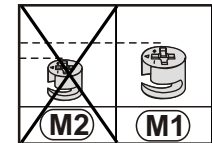
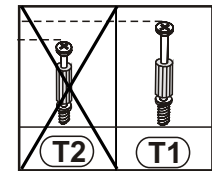

4

- | | | | |
|-----------|---|------|----|
| B1 |  | 8x28 | x8 |
| M1 |  | | x8 |
| T1 |  | | x4 |

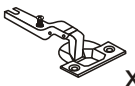

5

- M1**  x4
- T1**  x4
- B3**  6x45 X12
- Y1**  Kr15 x4
- S8**  4x13 x8
- U61**  x1
- A14**  M4x23 x1

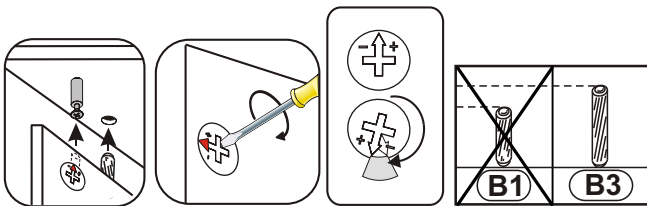
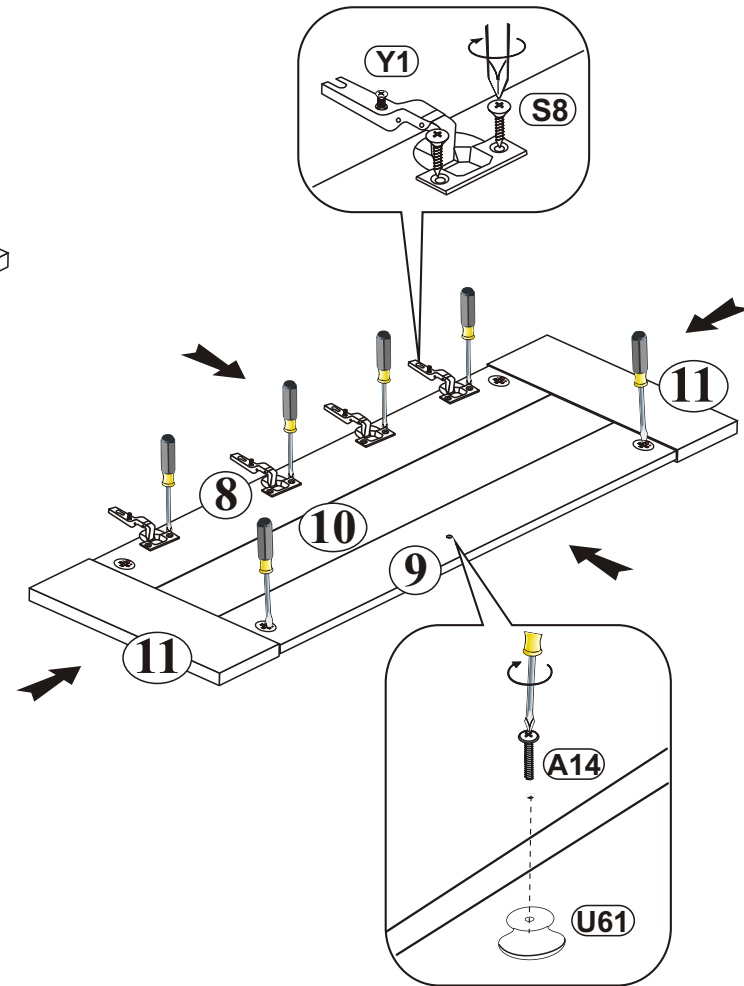
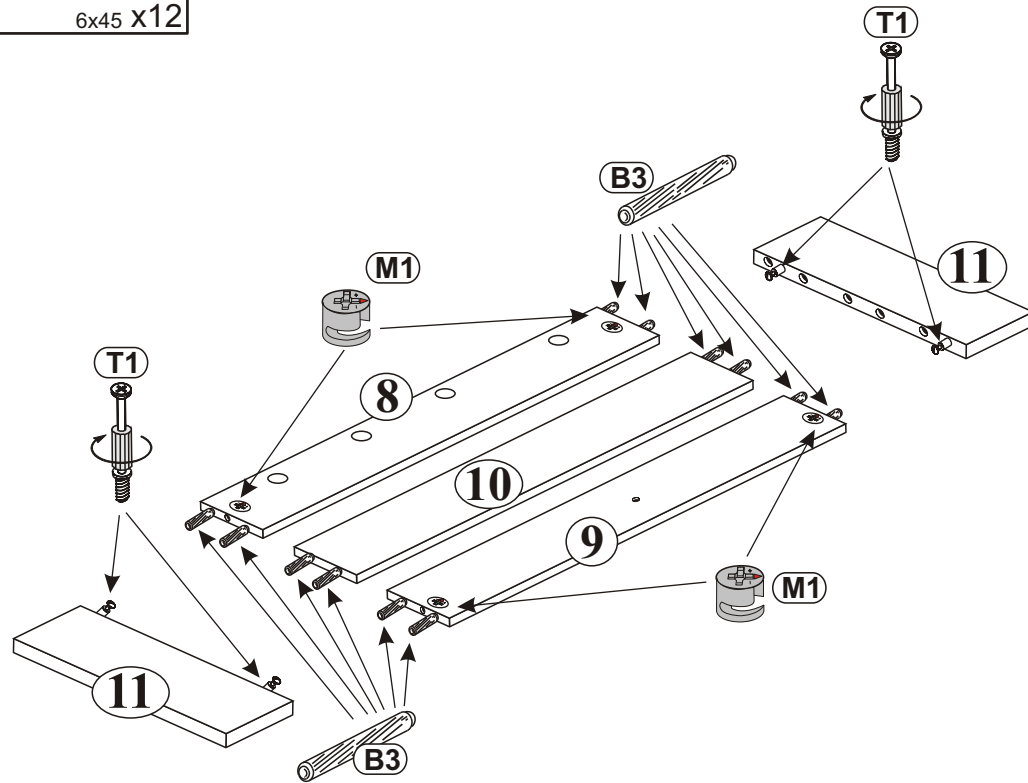

6

R22 L-350 mm x2L/2R	P5 4x30 x8 	U61 x2
M2 12x10mm x4 	A14 M4x23 x2 	J23 x4
P3 3x13mm x8 	T2 5x35mm x4 	

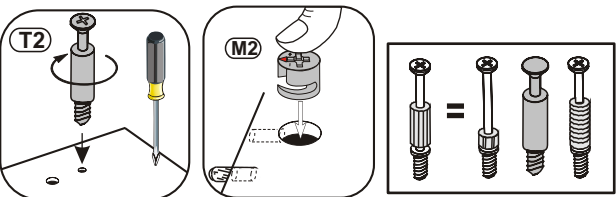
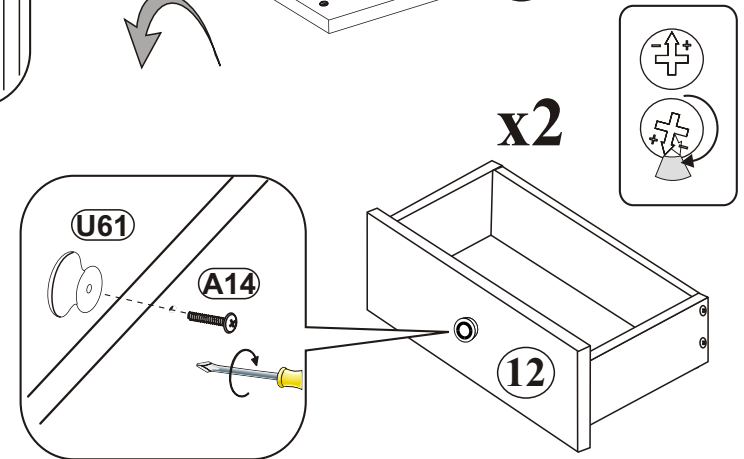
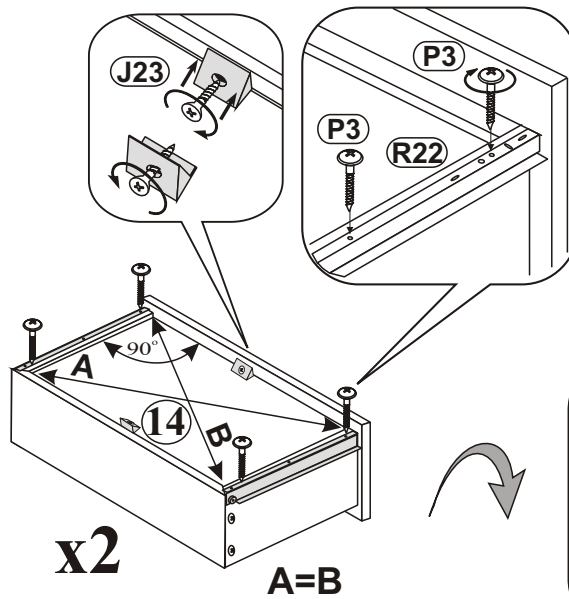
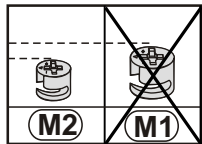
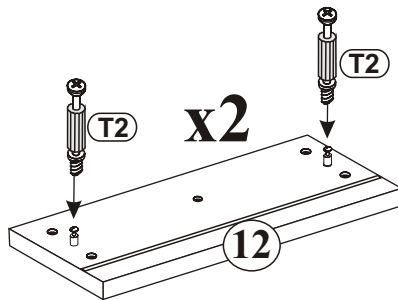
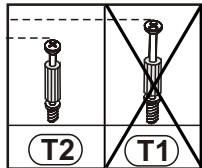
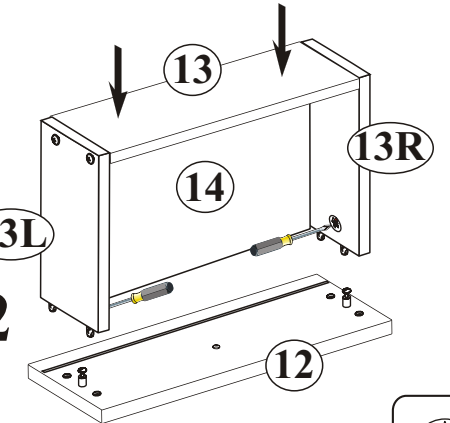
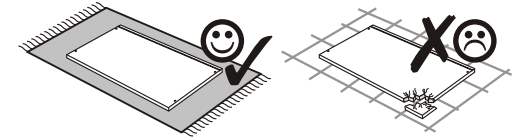
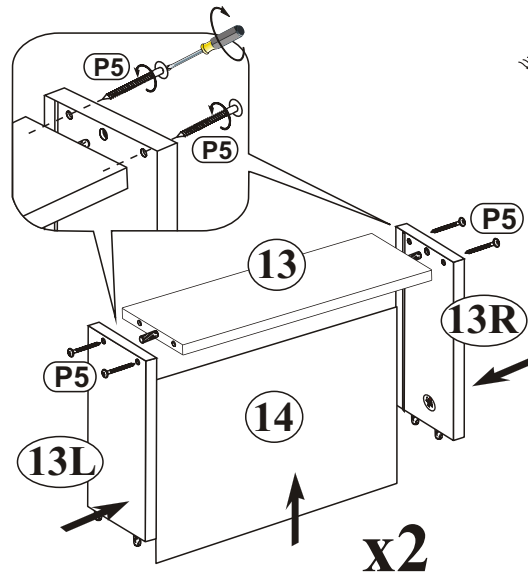
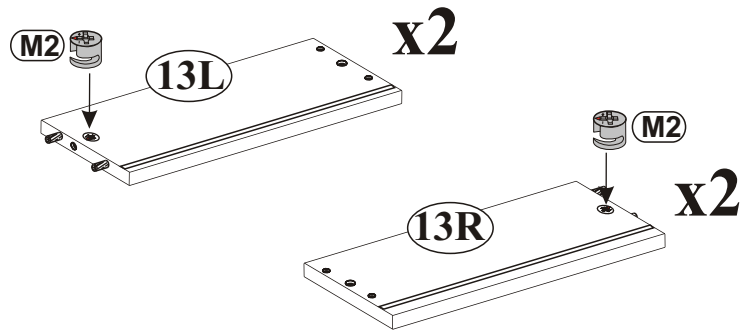

7

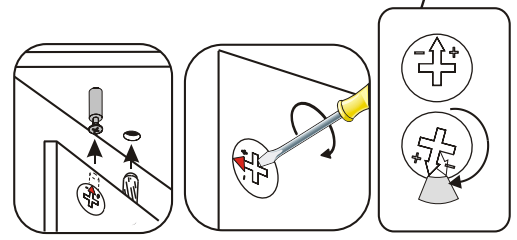
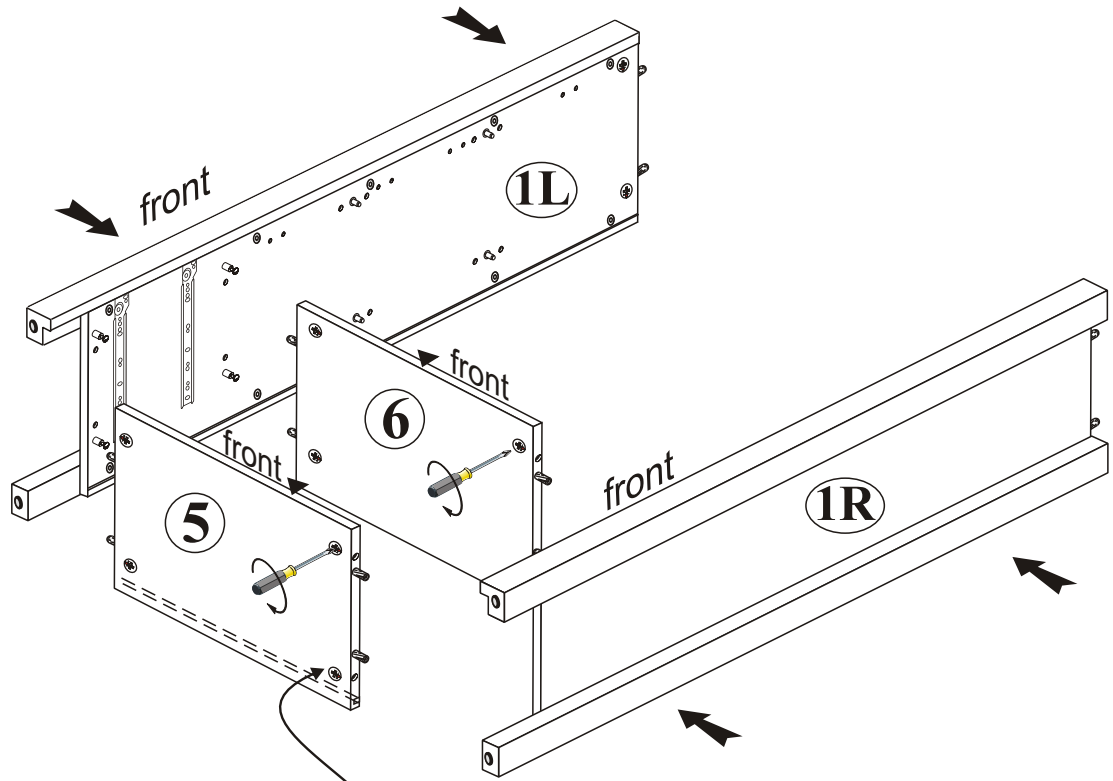

8

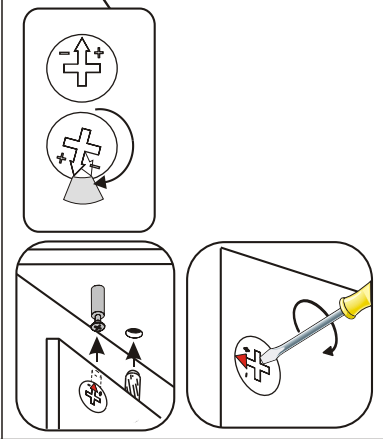
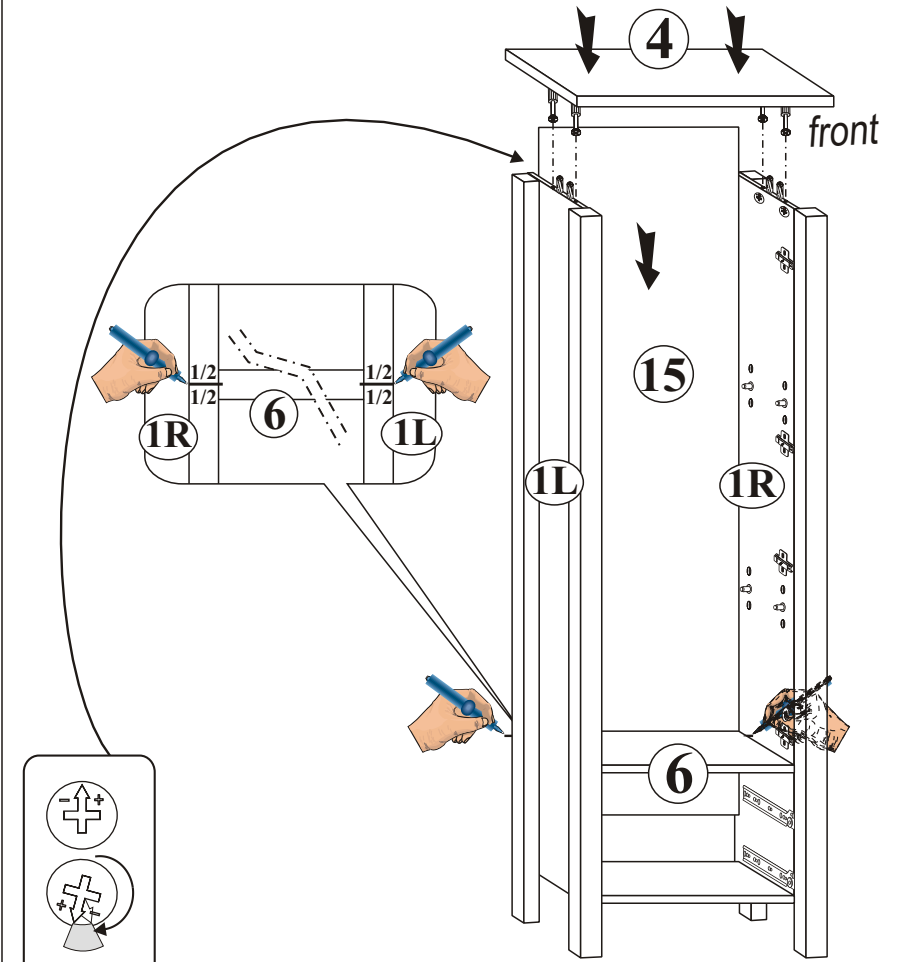

9

- S4** 3,0x20 x3
- J23** x20

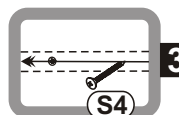
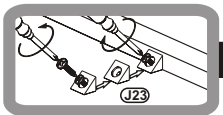
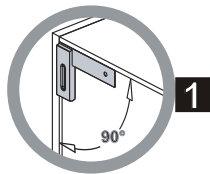
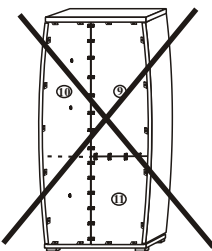
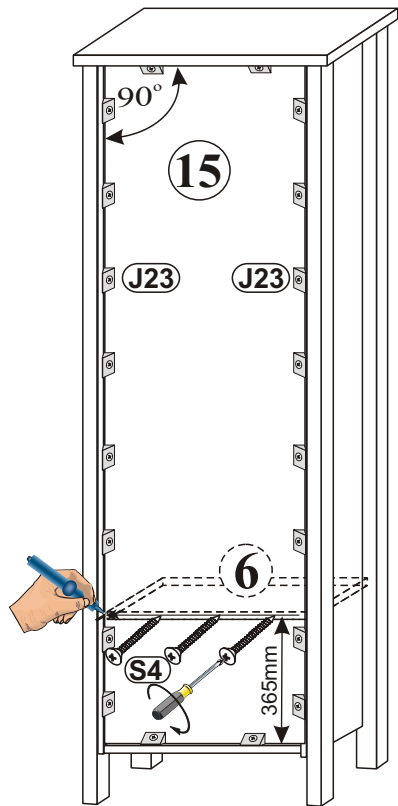

10

- J11** 1
- 2
- 3
- J11** **P13** 4
- J11** 5

- J11** x1
- P13** 3,5x13 mm x2
- C14** mm x8

