

# 3992A

Versionsnummer:  
Version number:  
Numer wersji:

10.2020

Naturholz kann sich werkstoffbedingt verziehen. Durch das Montieren ziehen sich Teile wieder plan.

Wood is a natural material and can be distorted. However, when the furniture is assembled, the parts straighten out.

Drewno jest surowcem naturalnym i może ulec wypaczeniu. Jednakże, po zmontowaniu mebla w całość części wyprostowują się.

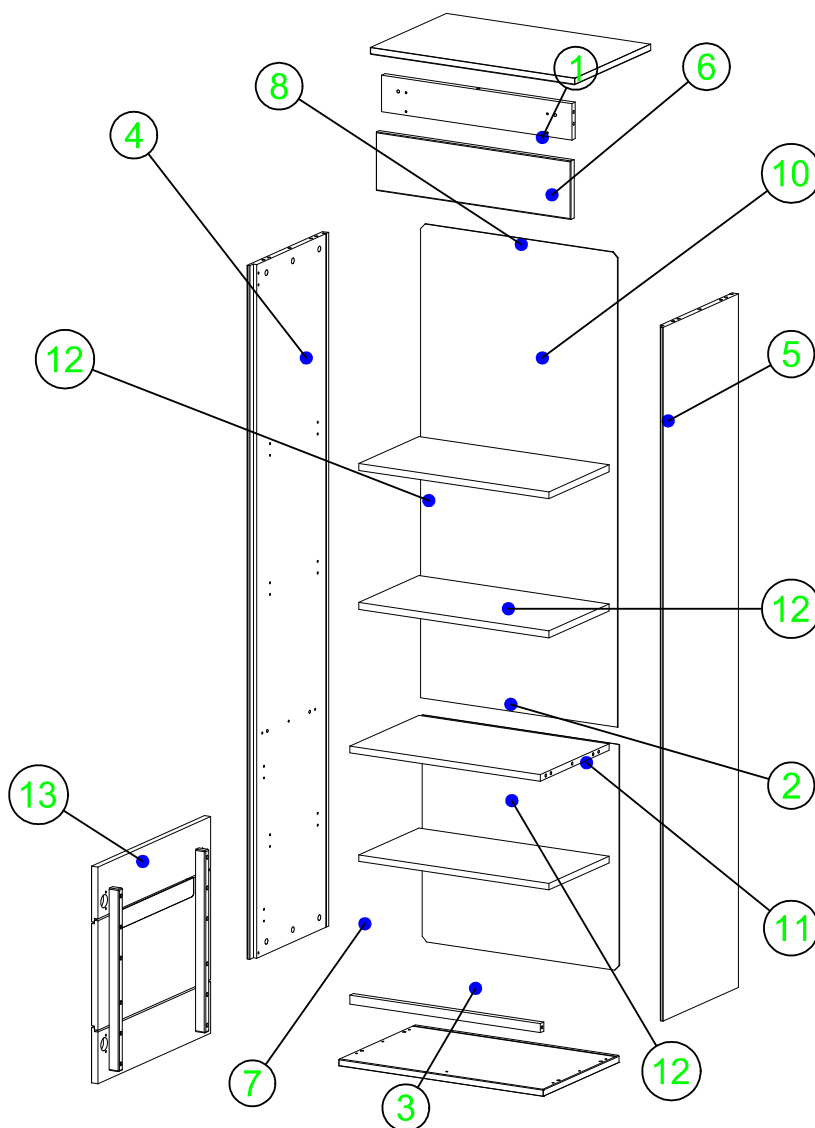
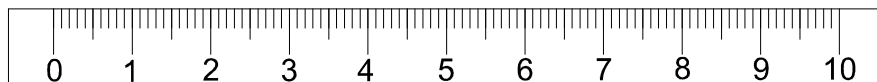

A  Ø 8x30 14	B  24	D  24	D2  2/2	E  Ø 6.3x13 2	F  2	G  Ø 4x30 12	H  5
I  12	J  Ø 5x13 4	P  5	V  4	U  1	Z  2	Q  20	

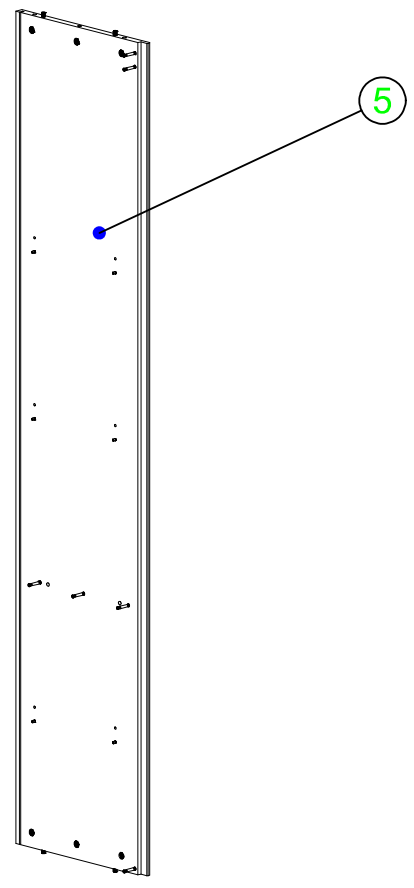
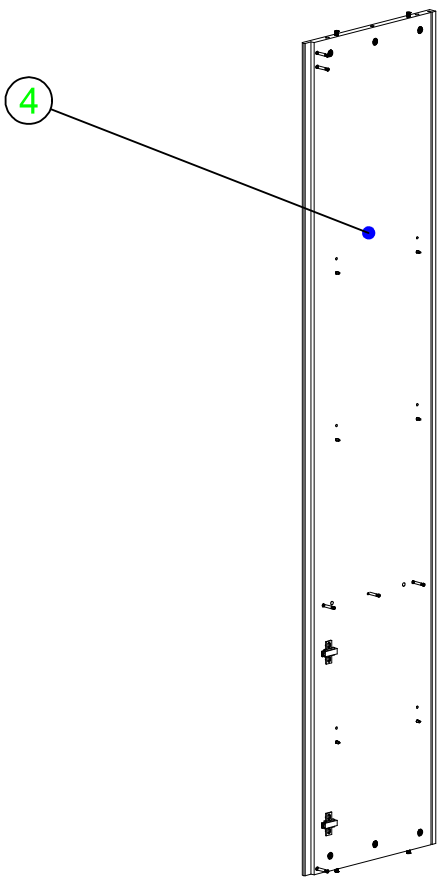
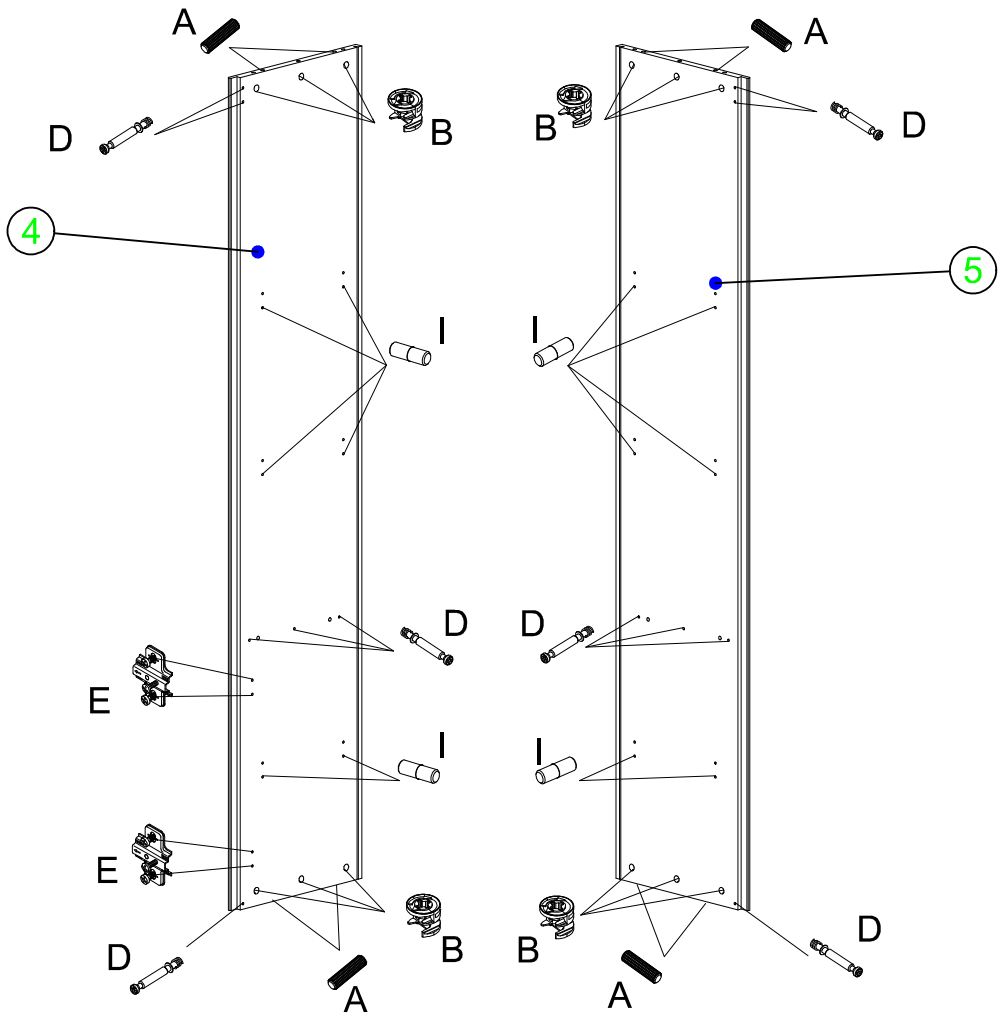

I

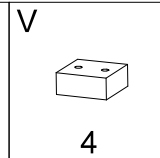
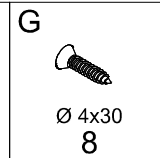
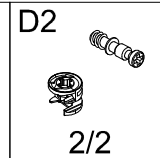
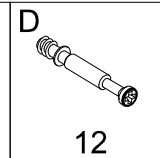
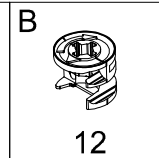
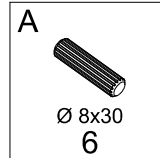
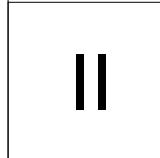
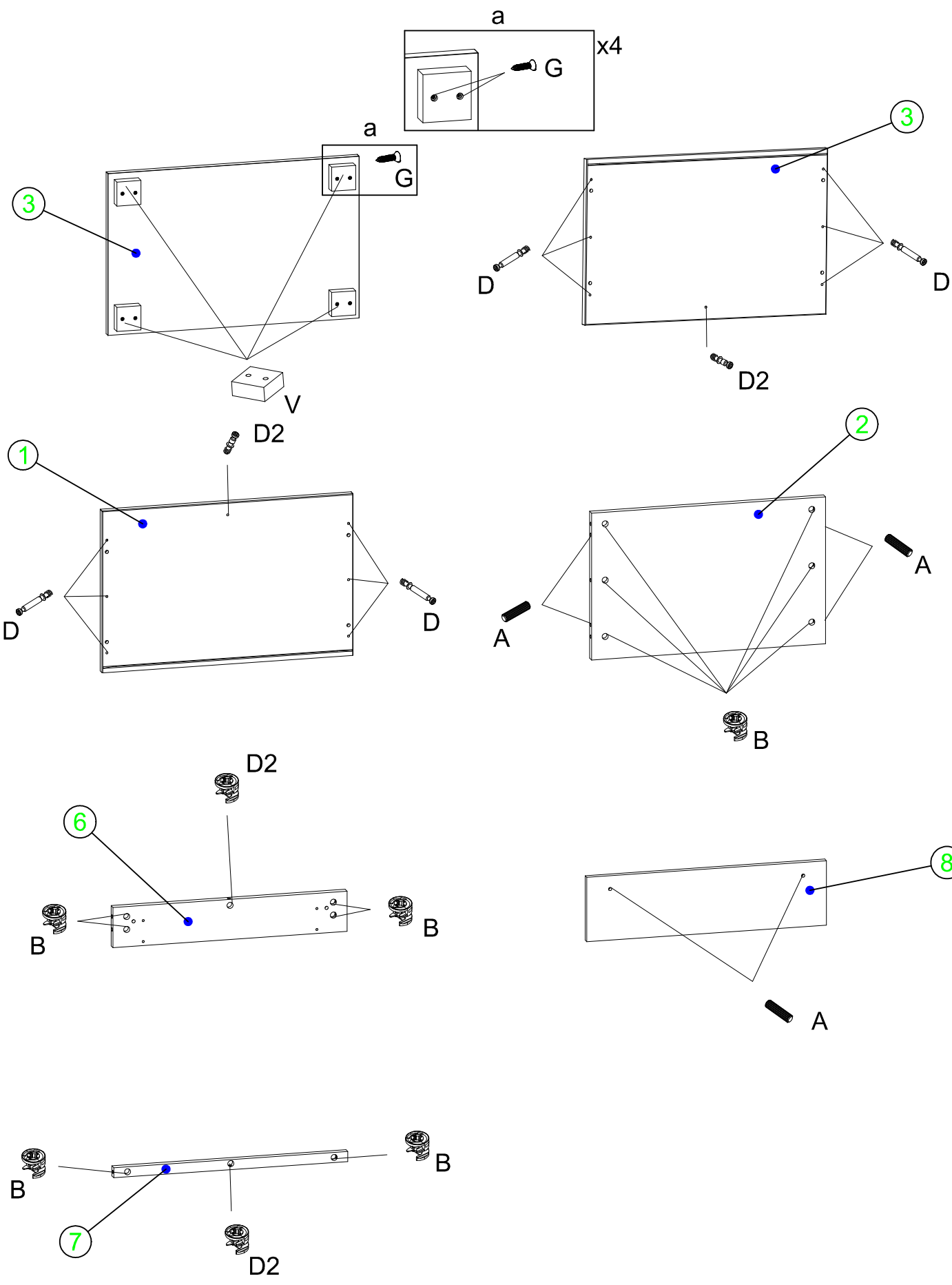

<p>A</p> <p>Ø 8x30 8</p>	<p>B</p> <p>12</p>	<p>D</p> <p>12</p>	<p>E</p> <p>Ø 6.3x13 2</p>	<p>I</p> <p>12</p>
------------------------------	--------------------	--------------------	--------------------------------	--------------------

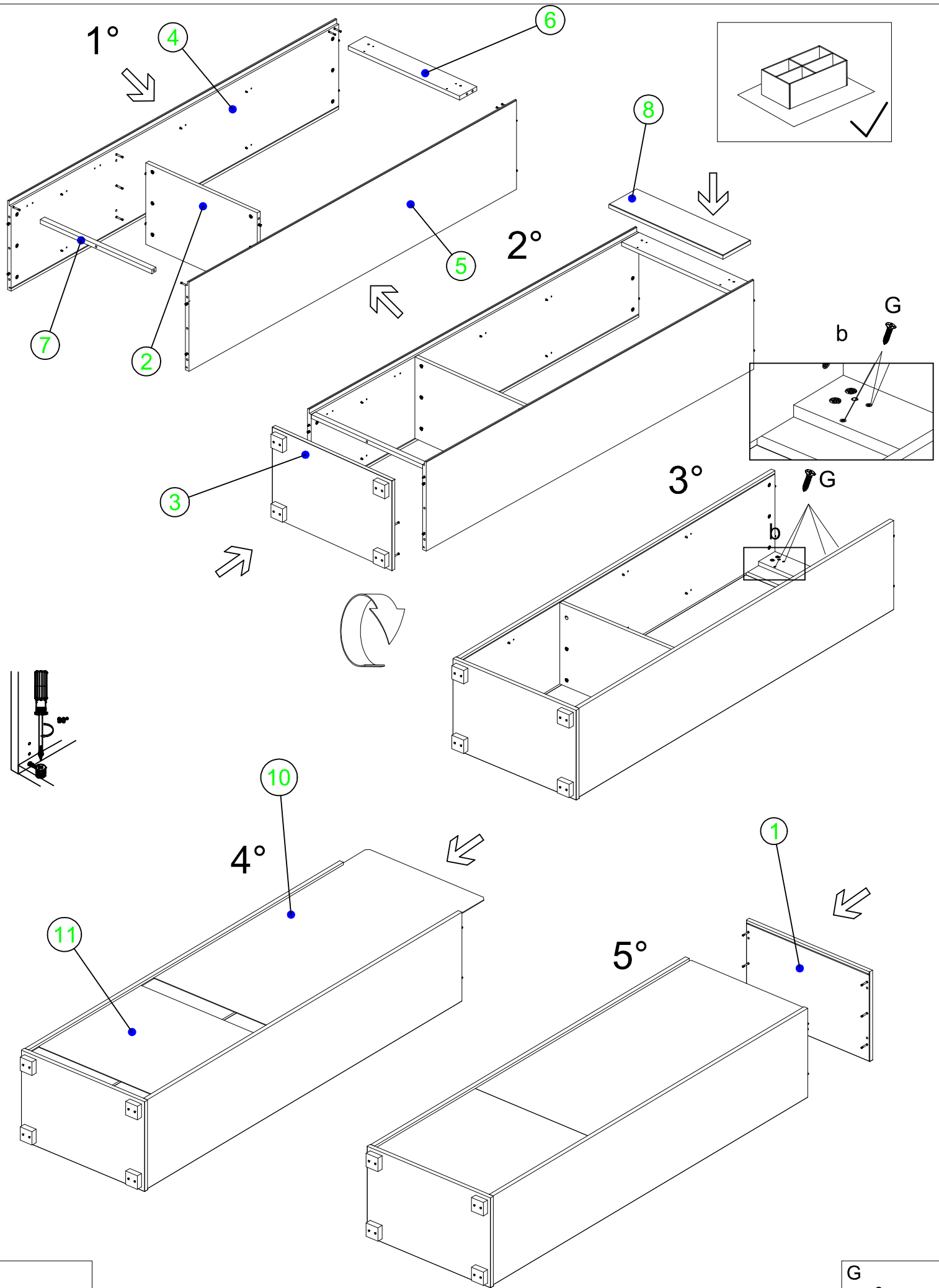



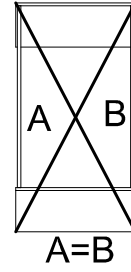
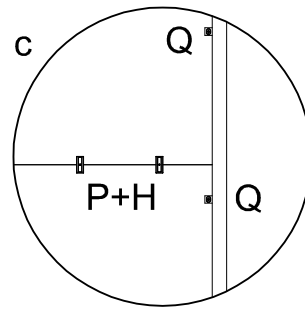
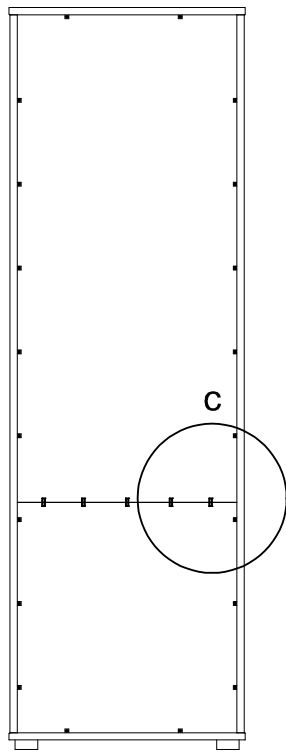



IV

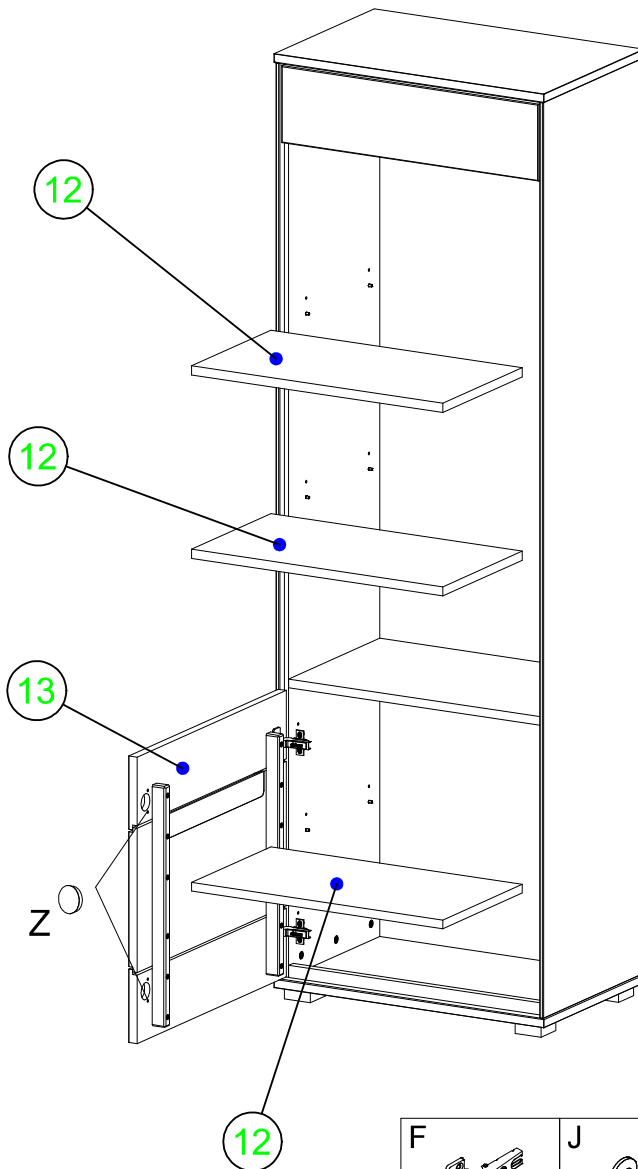
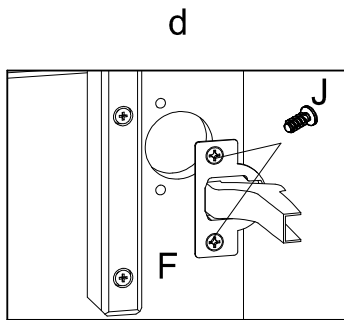
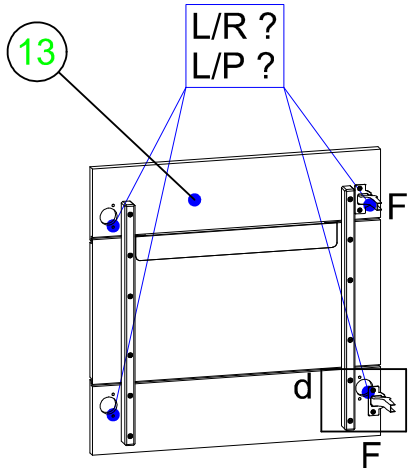

H	P	Q
		
5	5	20



V

F	J	Z
		
2	Ø 5x13 4	2

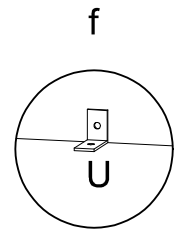
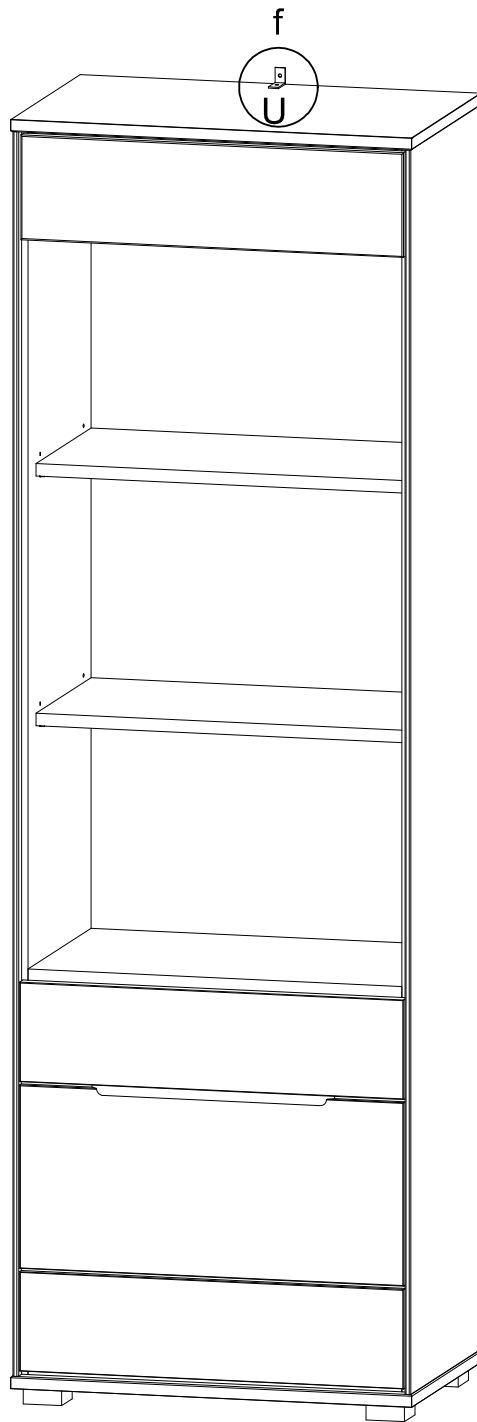

VI

