

3995

Versionsnummer:
Version number:
Numer wersji:

10.2020

Naturholz kann sich werkstoffbedingt verziehen. Durch das Montieren ziehen sich Teile wieder plan.

Wood is a natural material and can be distorted. However, when the furniture is assembled, the parts straighten out.

Drewno jest surowcem naturalnym i może ulec wypaczeniu. Jednakże, po zmontowaniu mebla w całość części wyprostowują się.

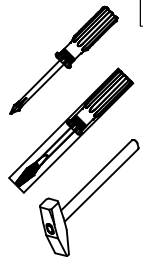
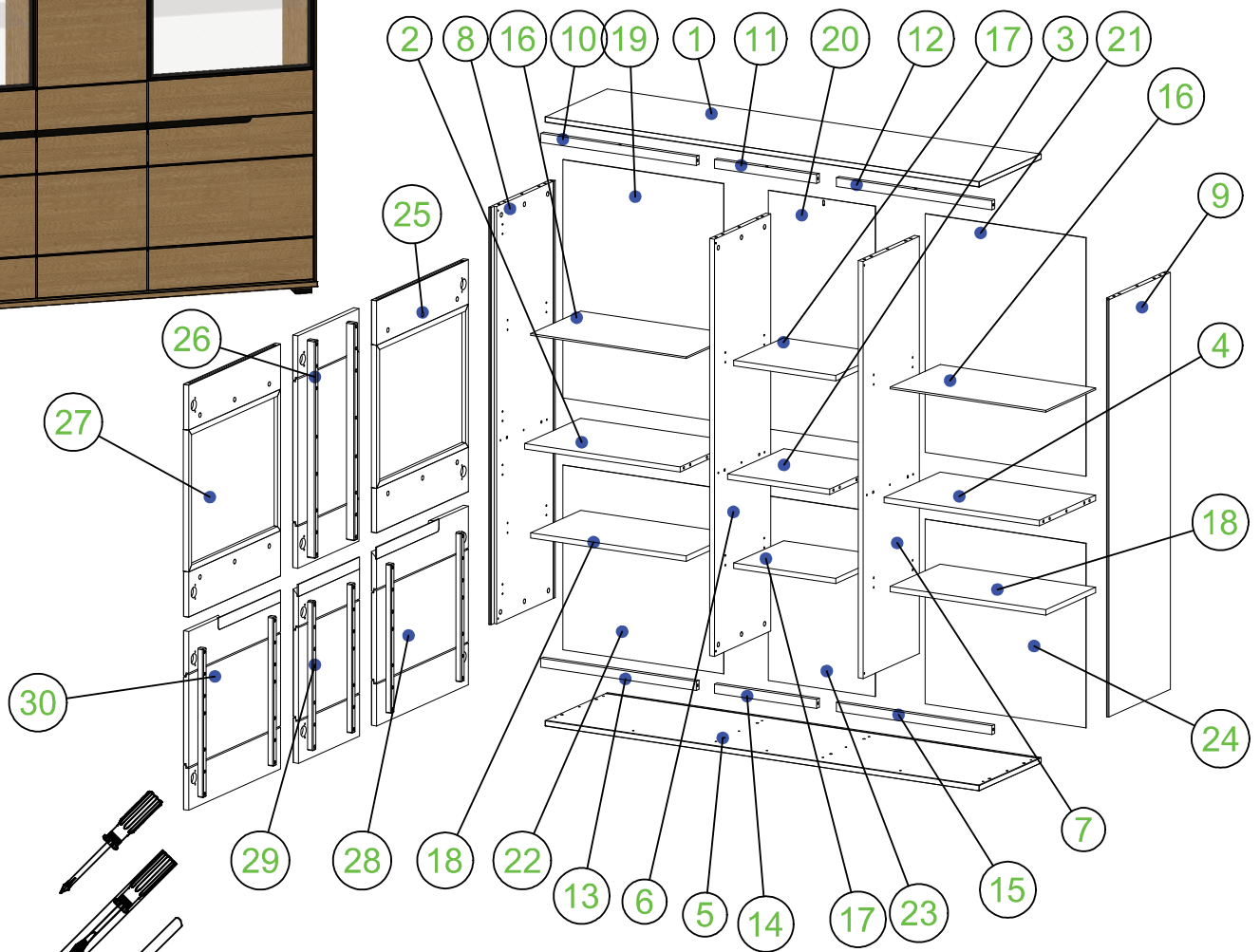
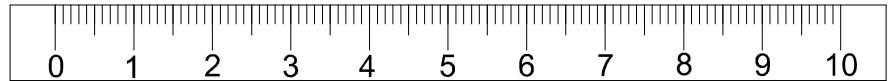
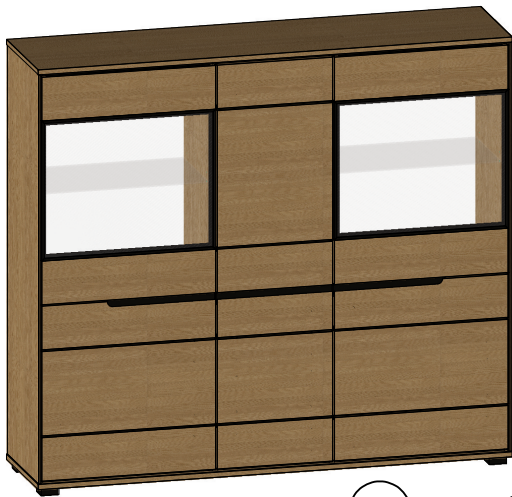

A Ø 8x30 20	A1 Ø 8x50 4	B 34	D 34	D1 20/20	D2 6/6	E Ø 6.3x13 12	F 12	G Ø 4x30 10
H 40	I1 16	I2 8	J Ø 5x13 24	P 40	V 5	U 1	Q 26	

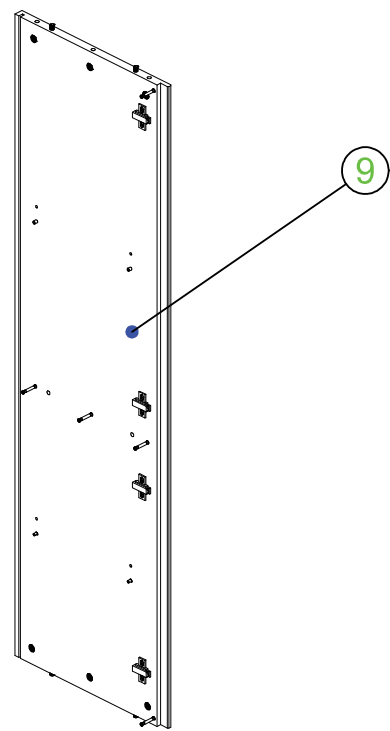
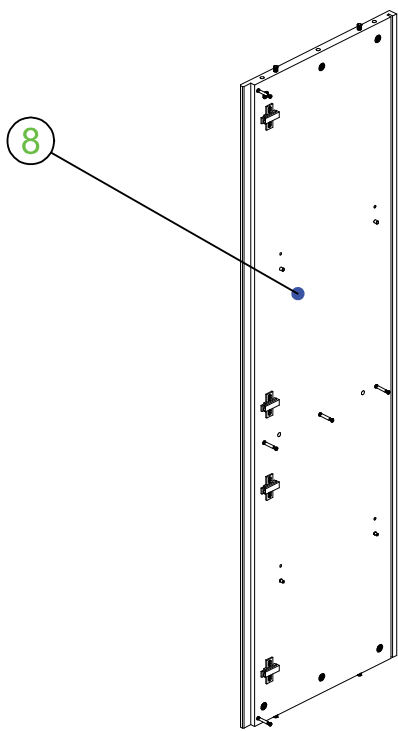
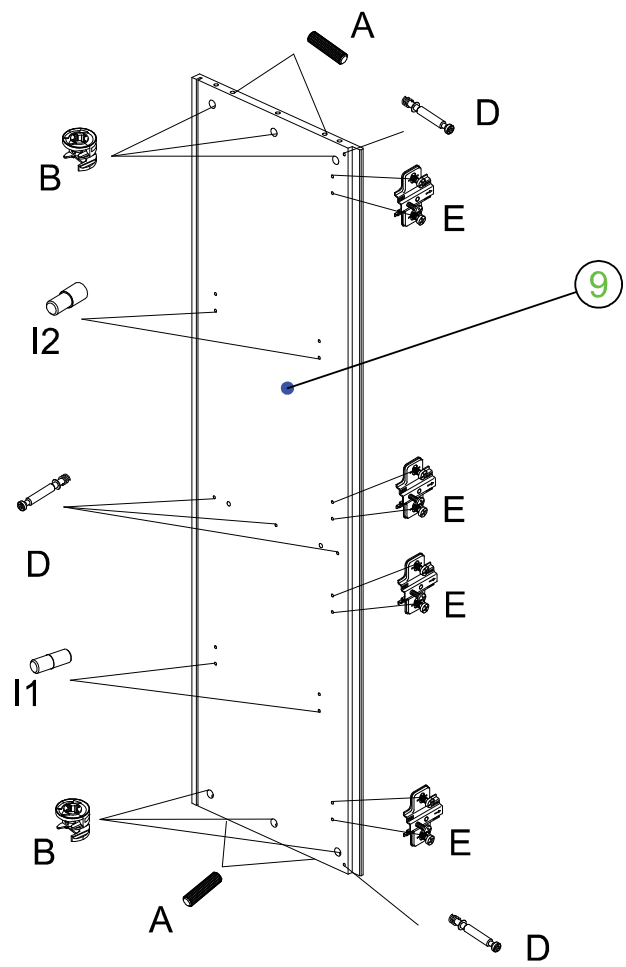
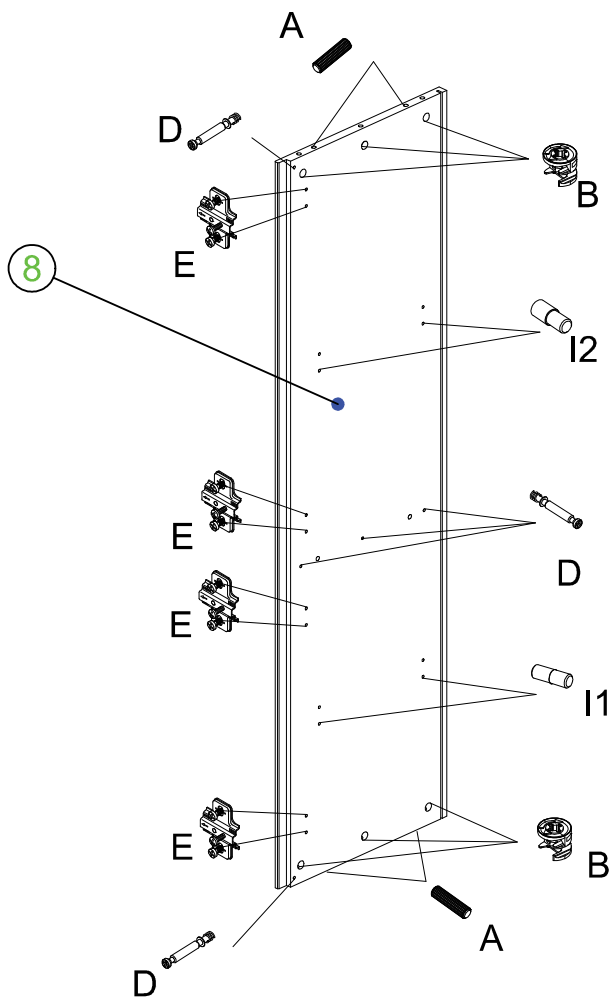

I

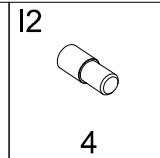
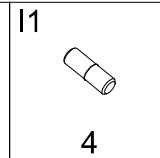
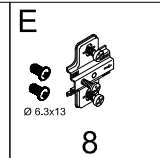
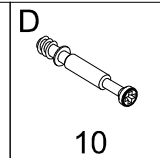
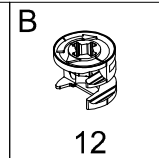
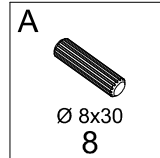

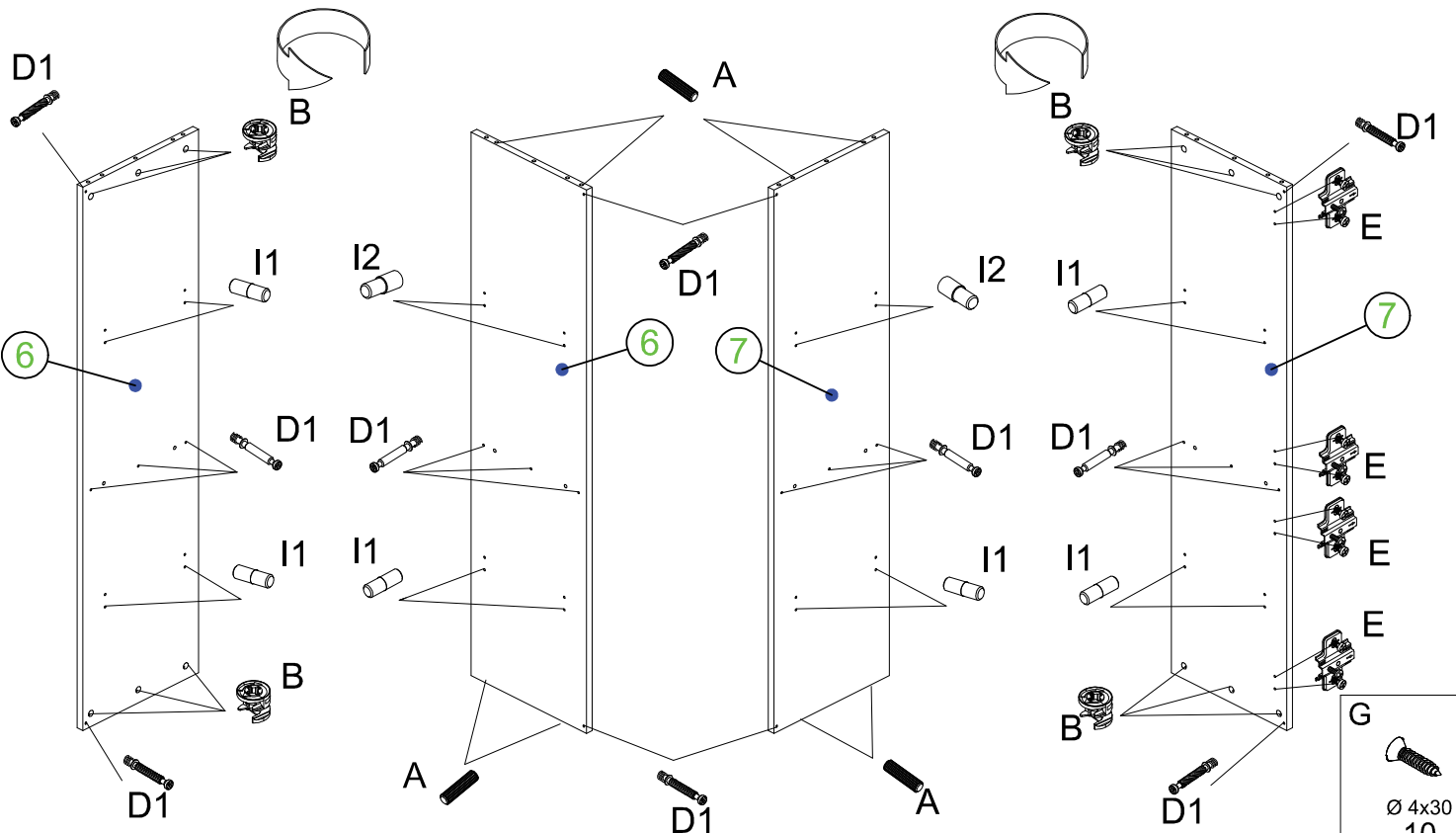
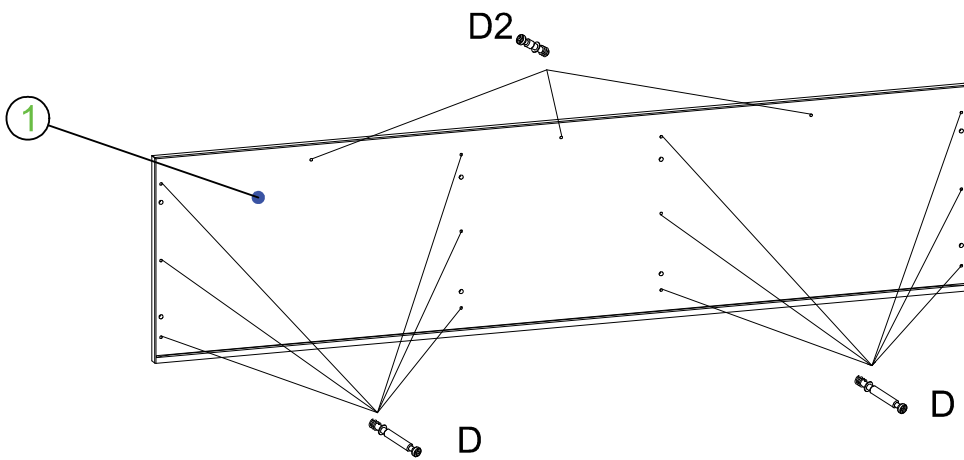
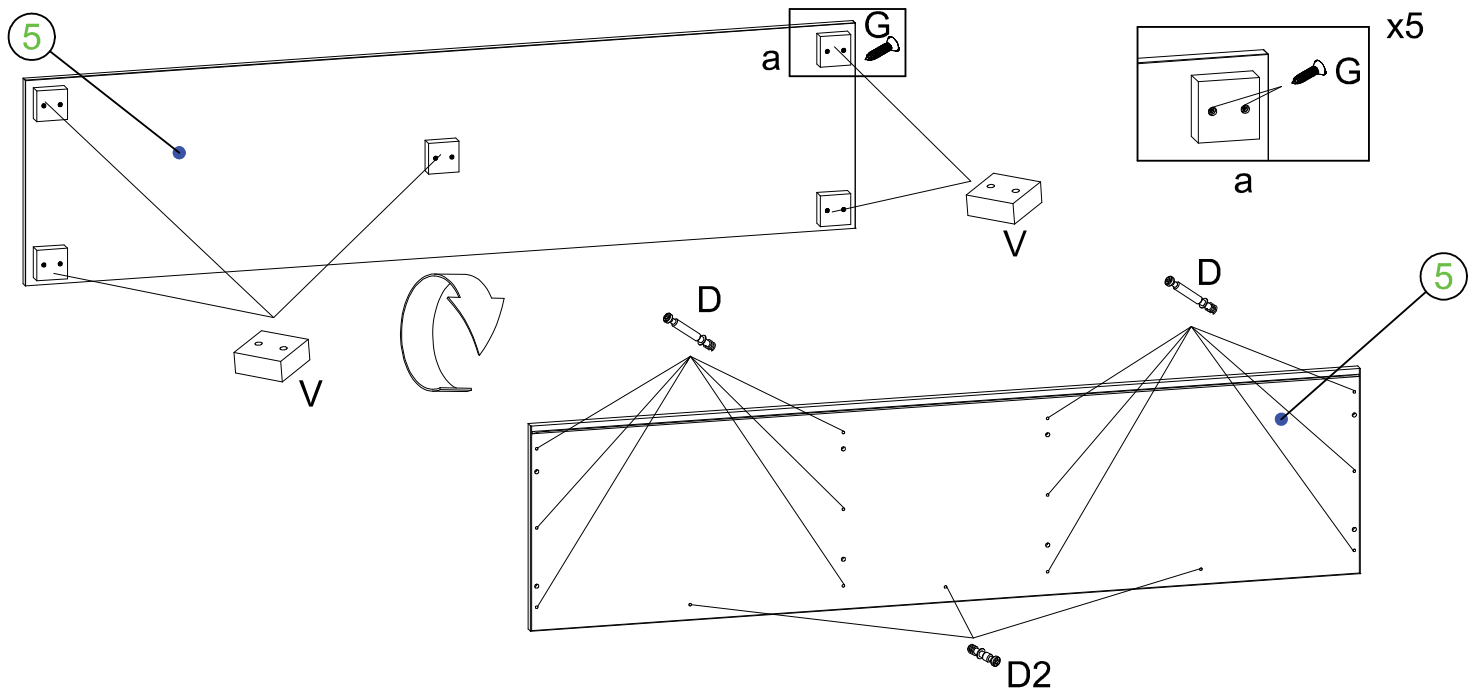

	A $\varnothing 8 \times 30$ 8	B 12	D 24	D1 0/20	D2 0/6	E $\varnothing 6.3 \times 13$ 4	I1 4 I2 12	V 5
--	--	--------------------	--------------------	-----------------------	----------------------	--	---	-------------------

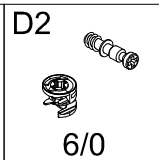
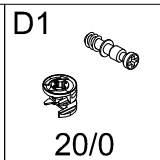
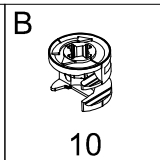
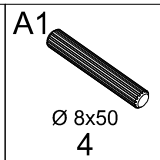
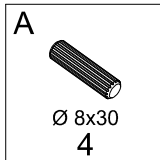
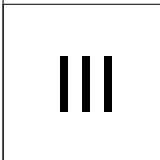
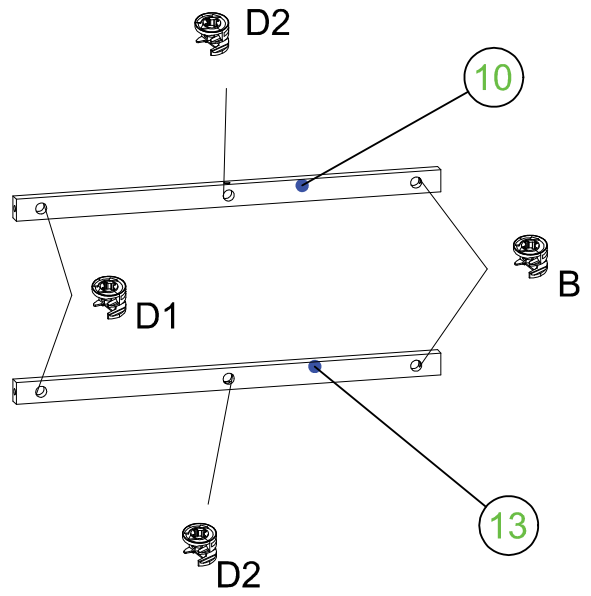
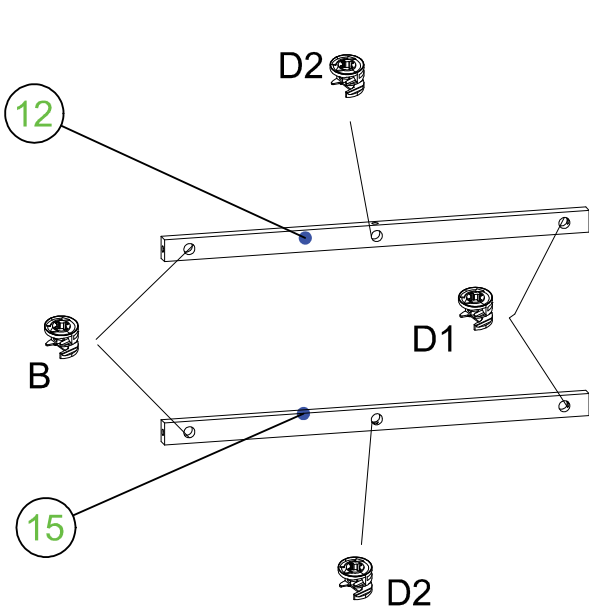
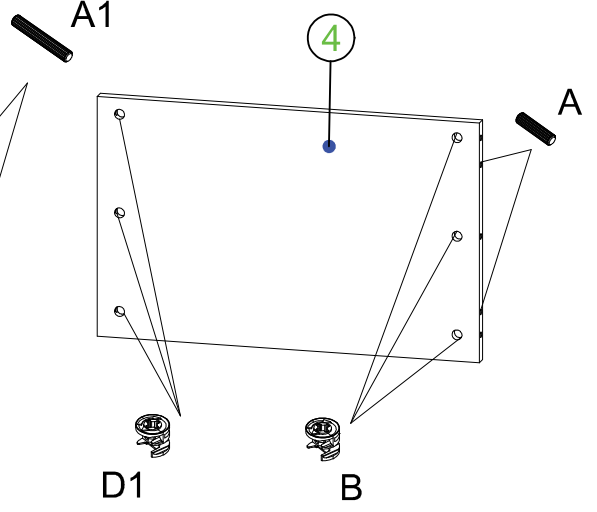
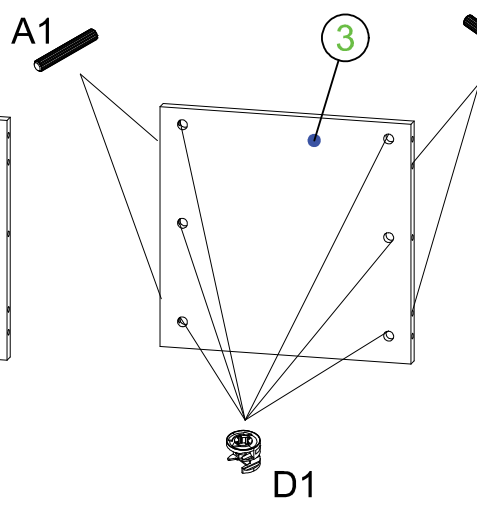
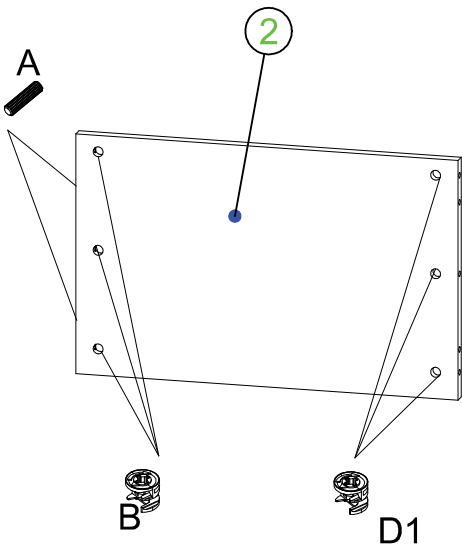
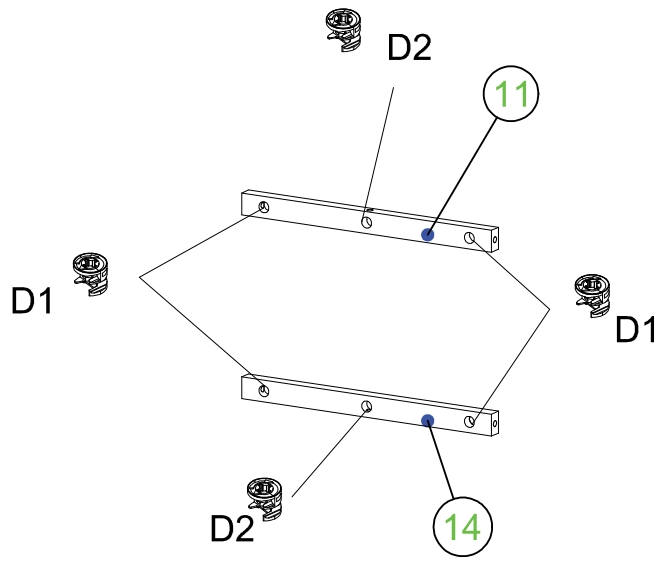

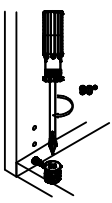
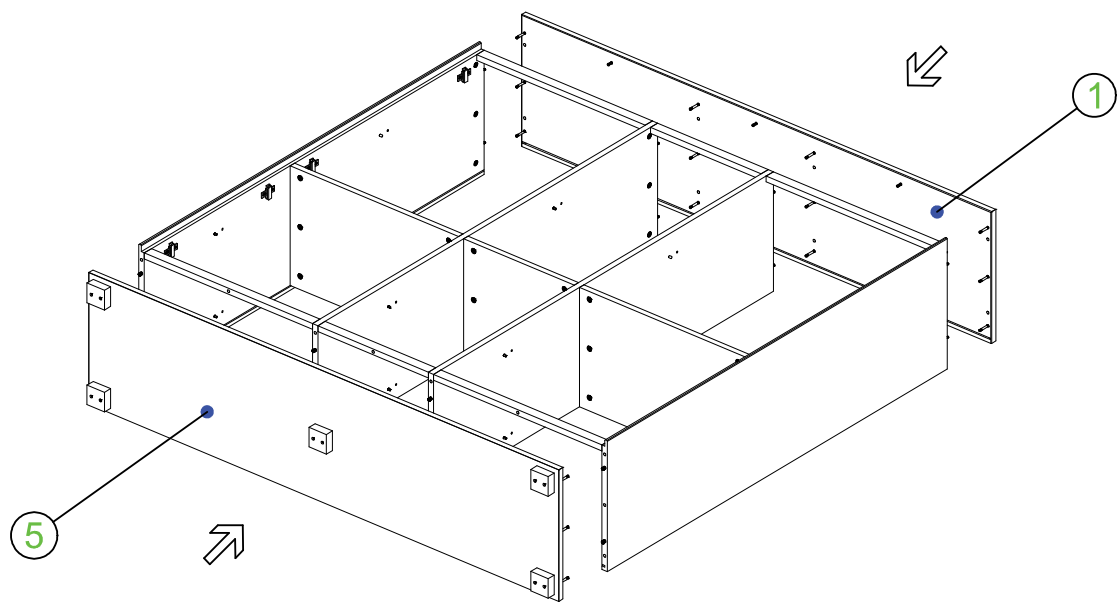
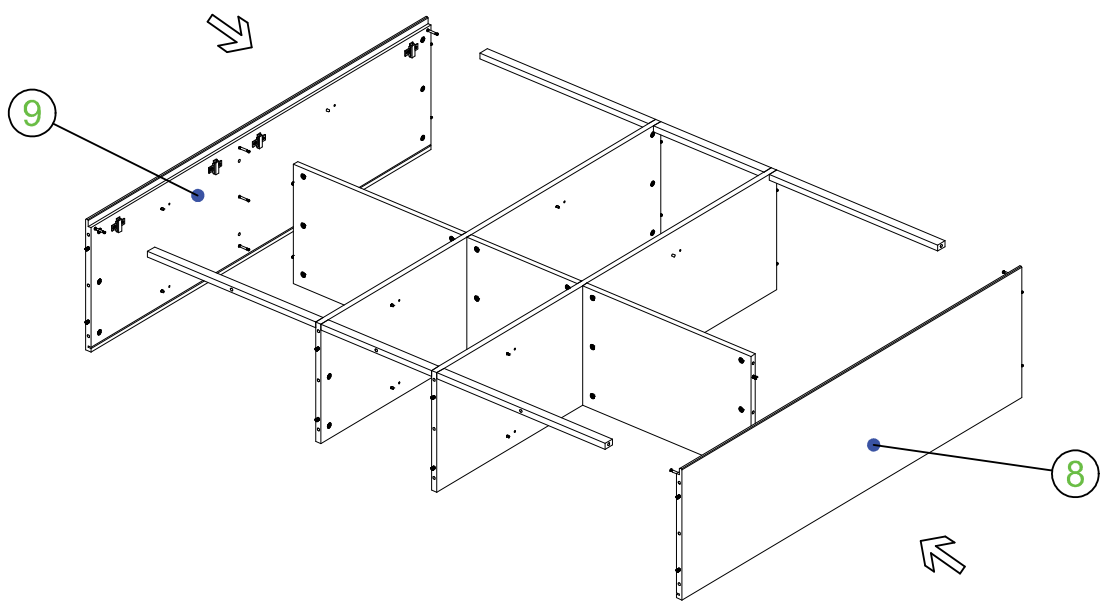
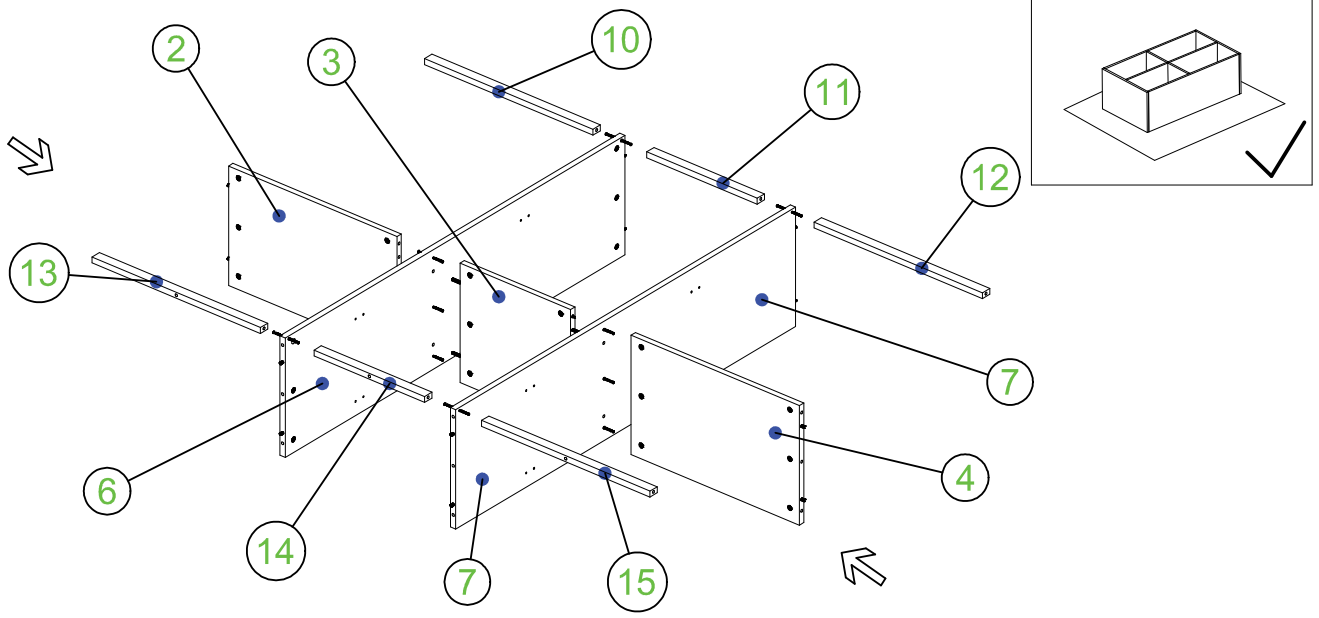

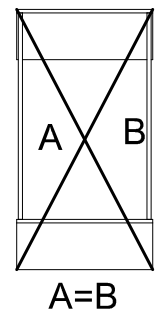
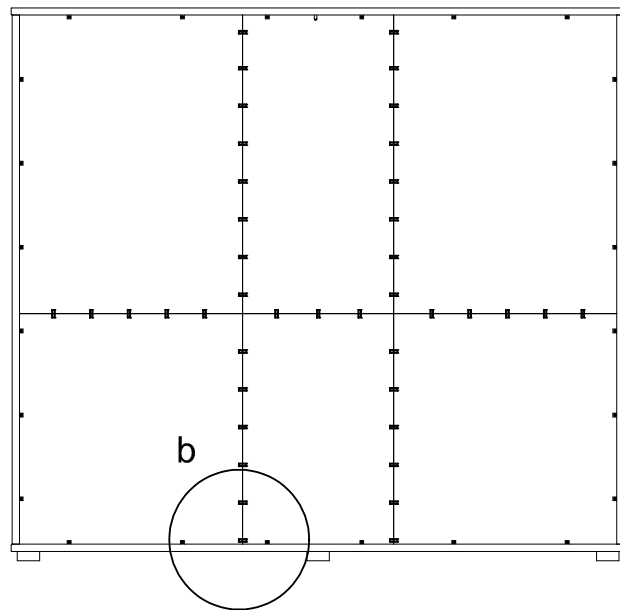
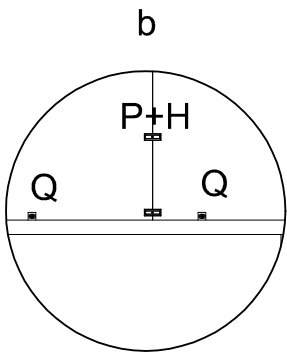
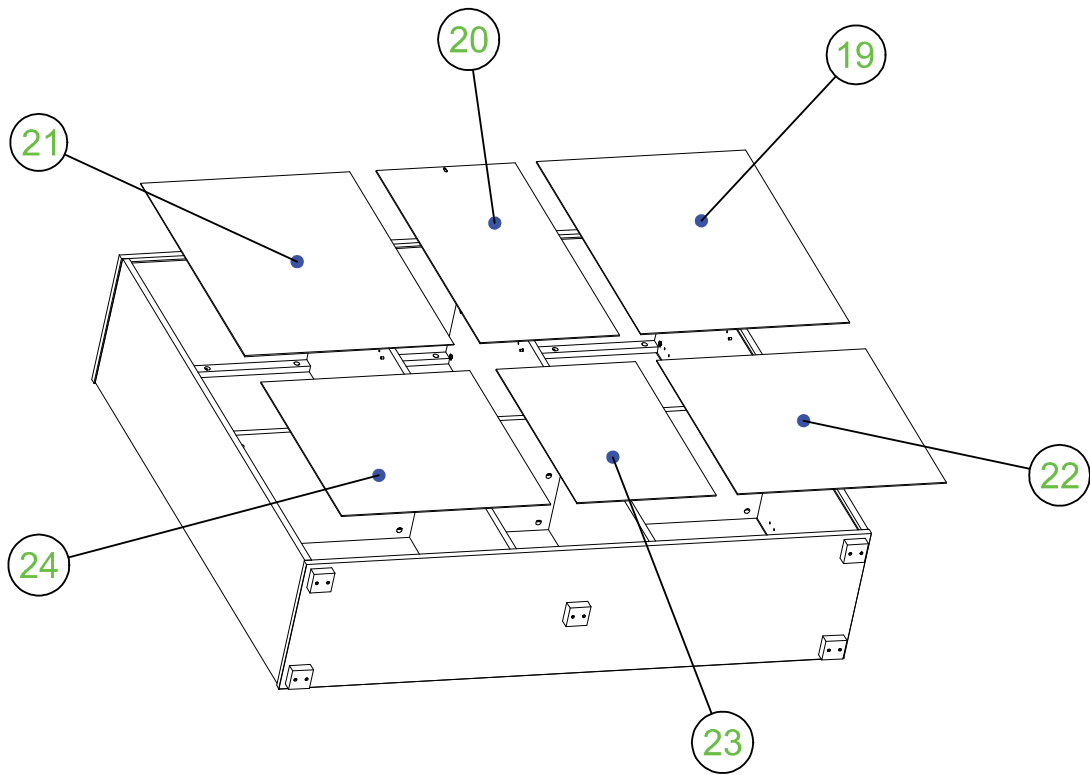

IV



V

H	P	Q
		
40	40	26

27

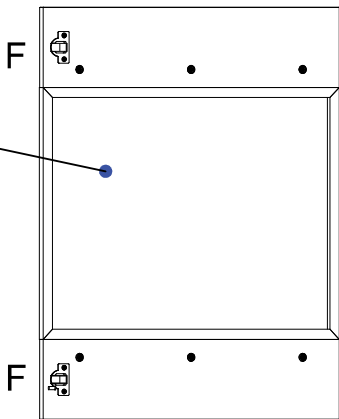

26

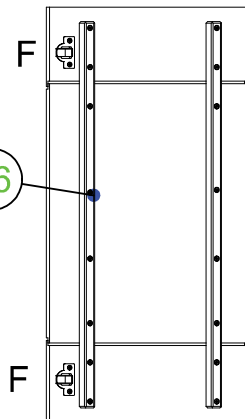

25

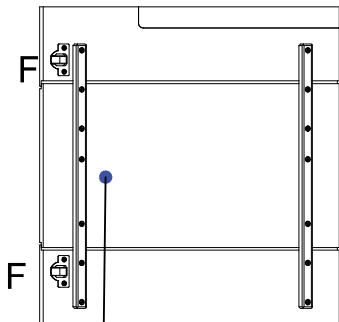
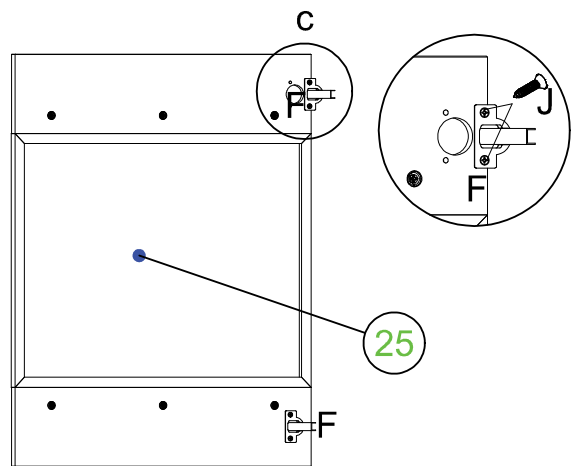

30

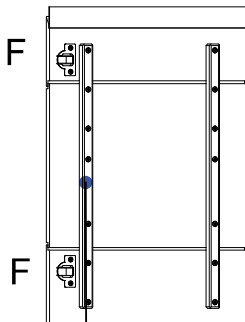

29

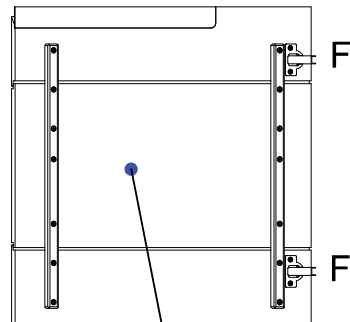

28

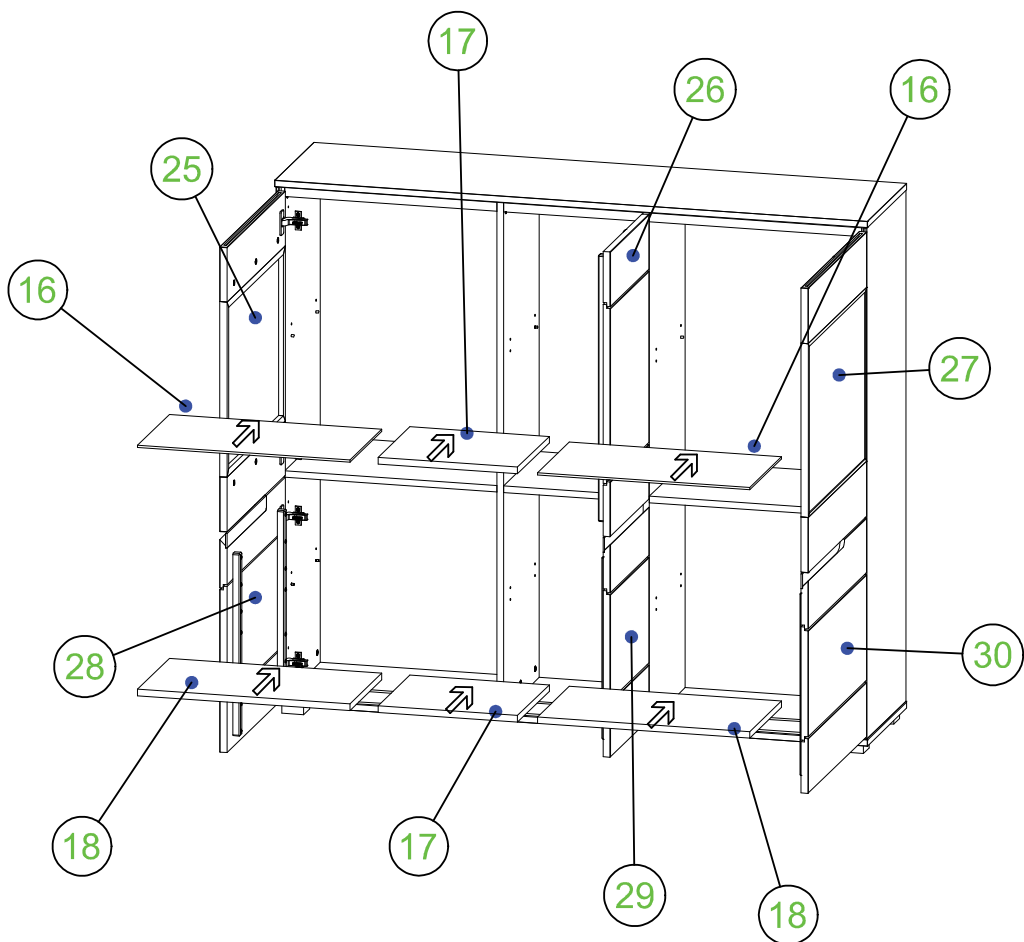

VI

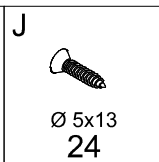
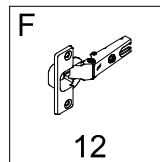

d

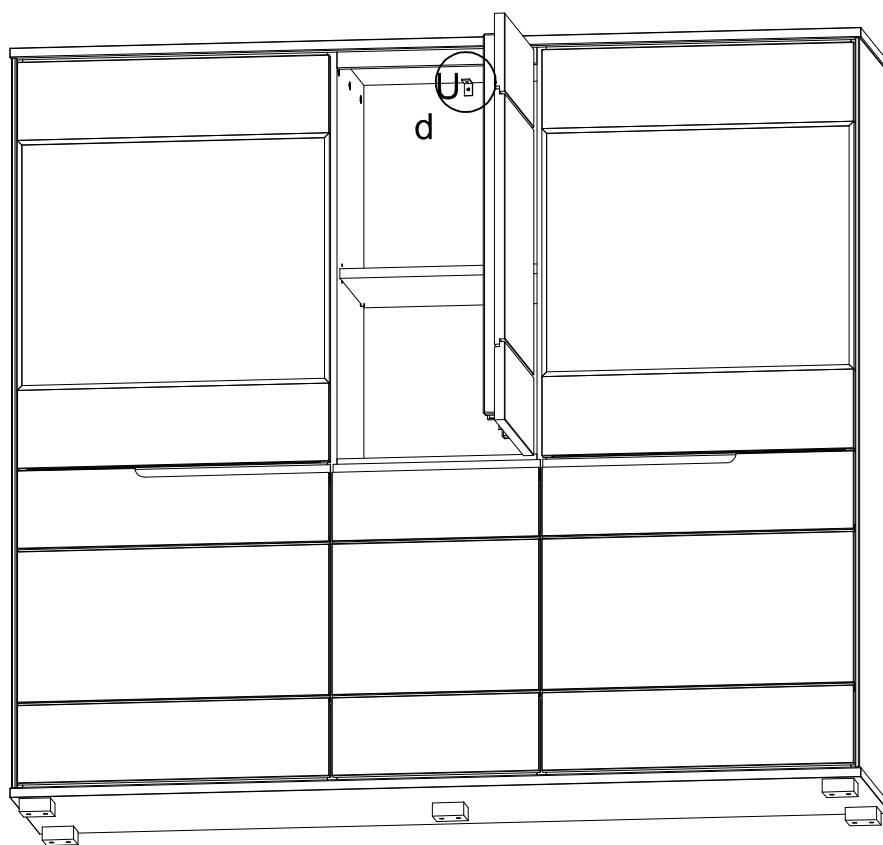
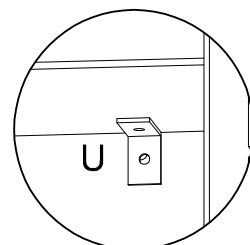

VII

