

Moris

Witryna 1W1D



number	Measurements	Pcs.
1	1964x375	1
2	1964x375	1
3	562x400	1
4	528x392	1
5	528x372	1
6	527x370	1
7	527x360	2
8	528x125	1
9	1964x80	1
10	1964x80	1

11	1051x396	1
12	396x696	1
13	1902x547	1

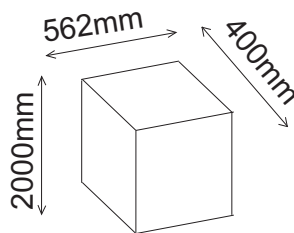
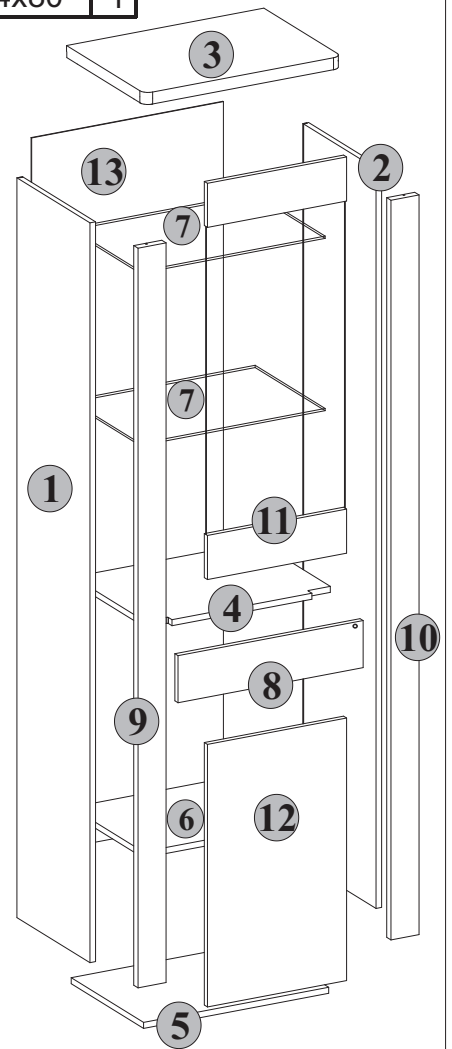
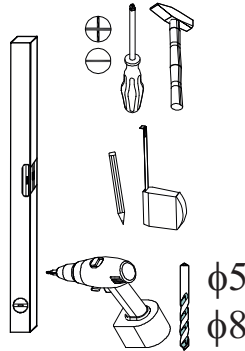
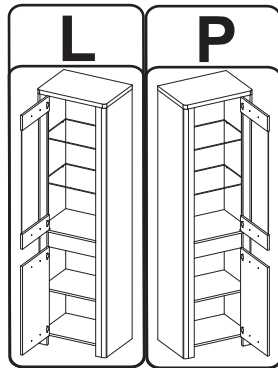
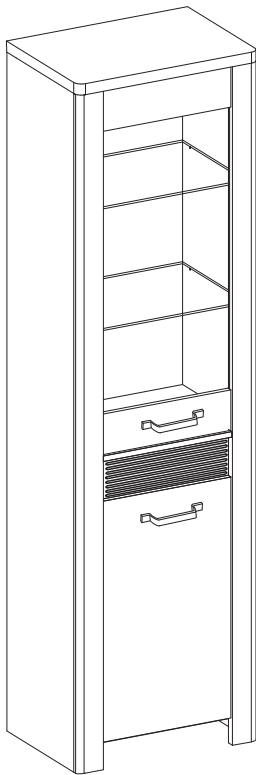

Option

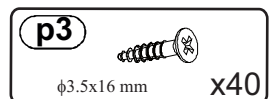
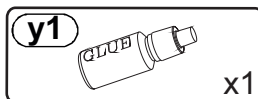
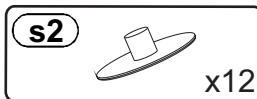
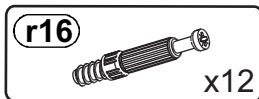
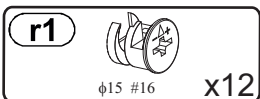
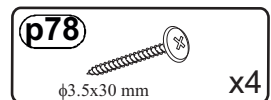
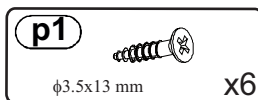
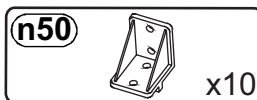
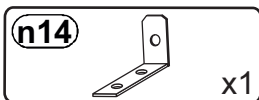
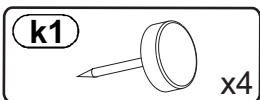
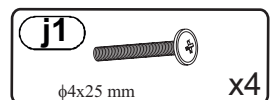
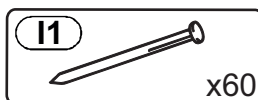
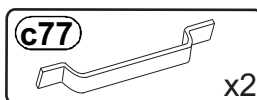
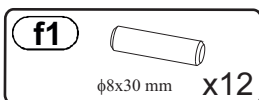
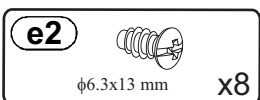
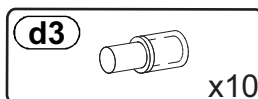
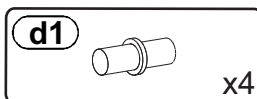
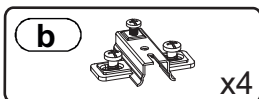
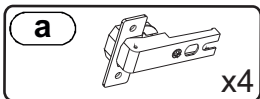
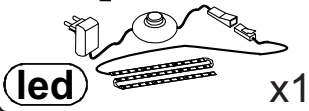

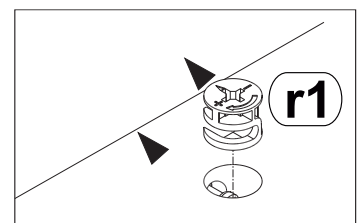
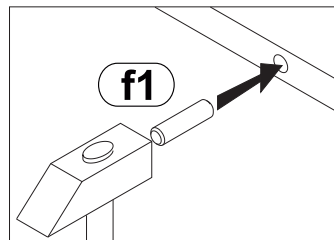
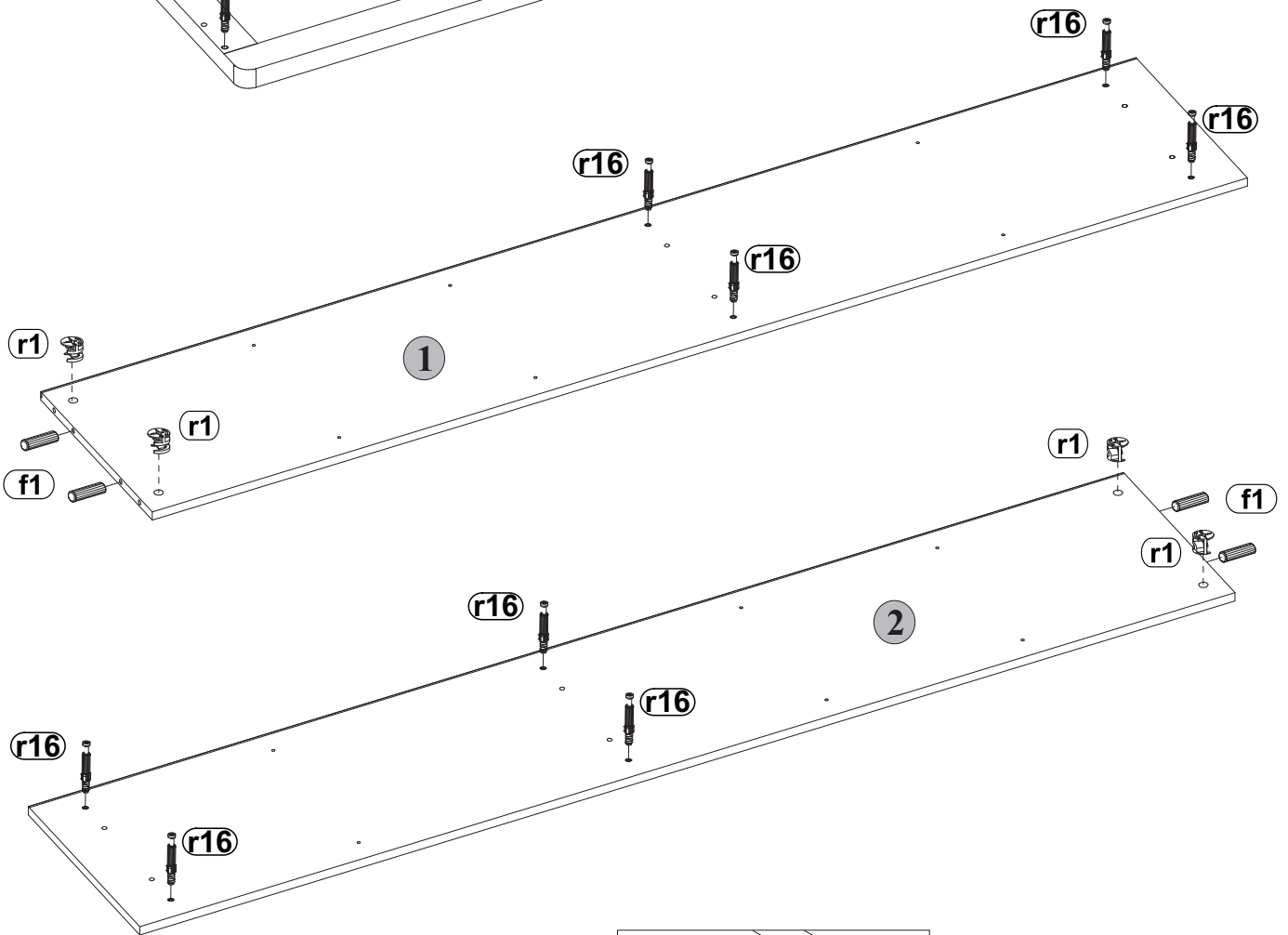
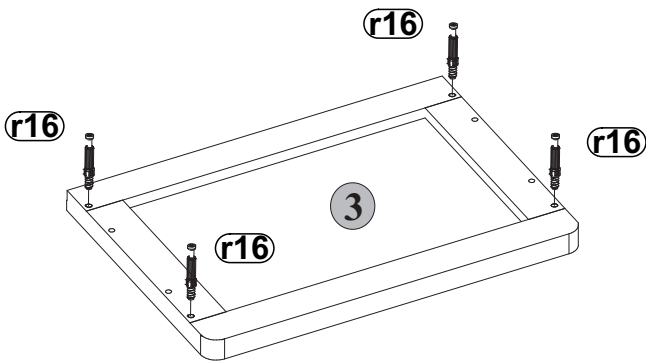
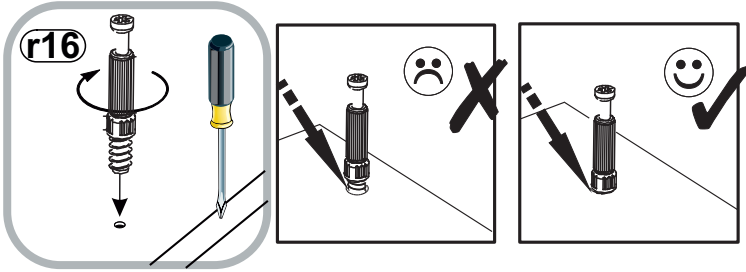
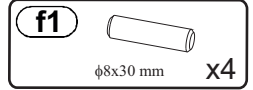
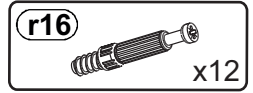
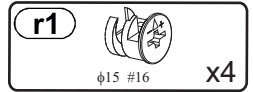
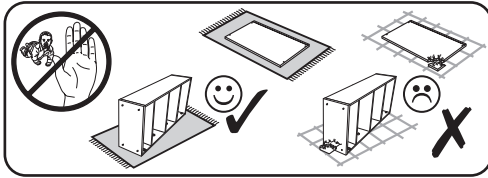

2

2

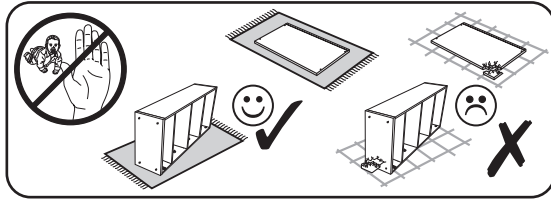

r1  $\phi 15 \#16$ x8

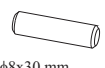
f1  $\phi 8 \times 30$ mm x8

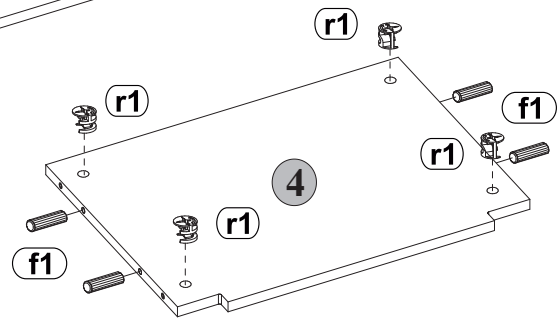
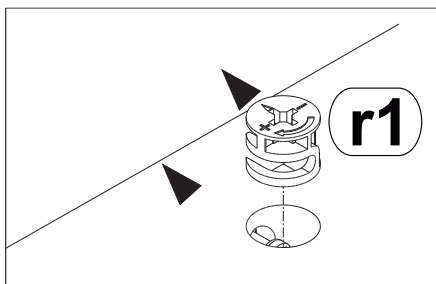
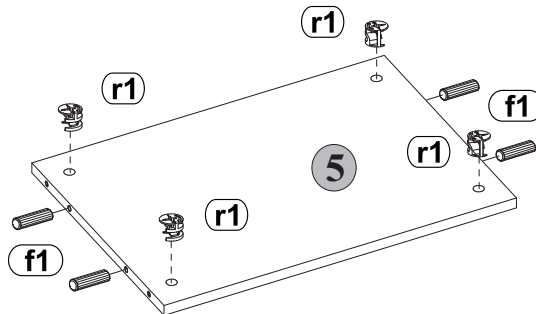
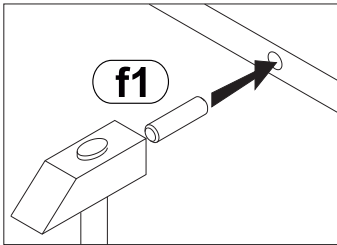

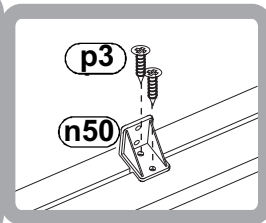
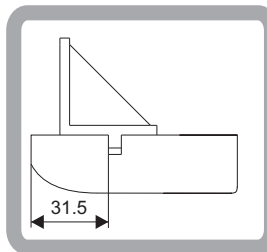
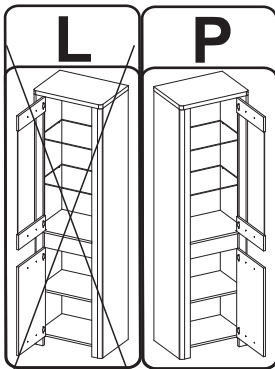

3 P

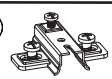

b  x4

n50  x10

e2  $\phi 6.3 \times 13$ mm x8

p3  $\phi 3.5 \times 16$ mm x20

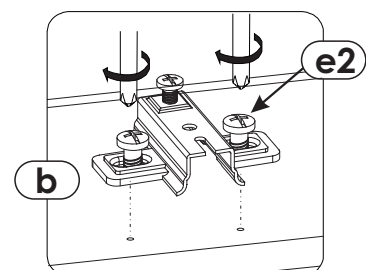
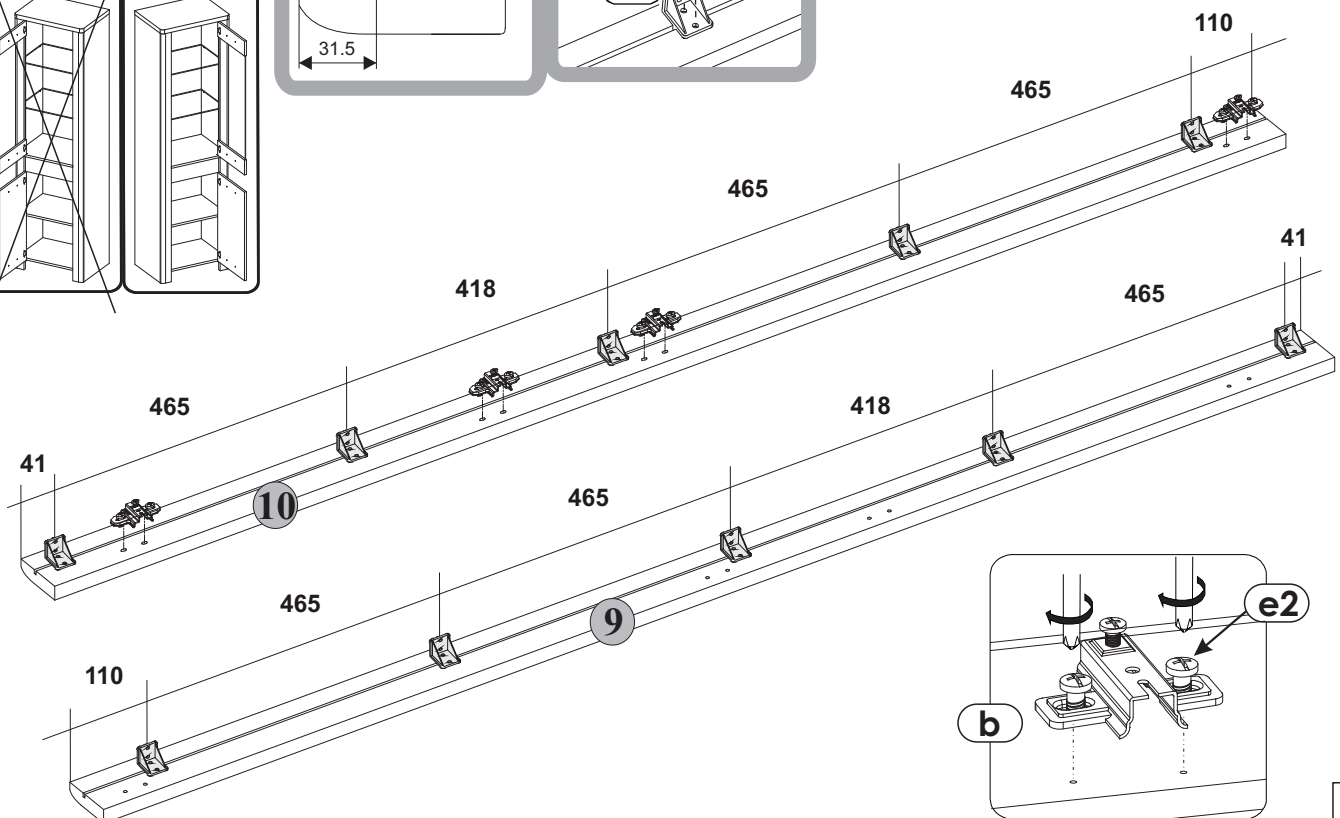

3

3 L

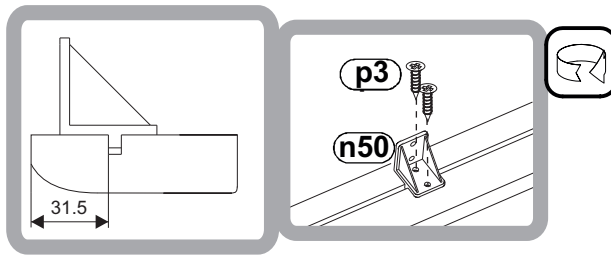
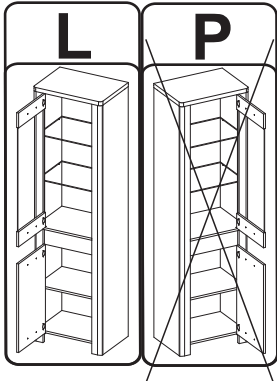

- b** x4
- n50** x10
- e2** $\phi 6.3 \times 13$ mm x8
- p3** $\phi 3.5 \times 16$ mm x20

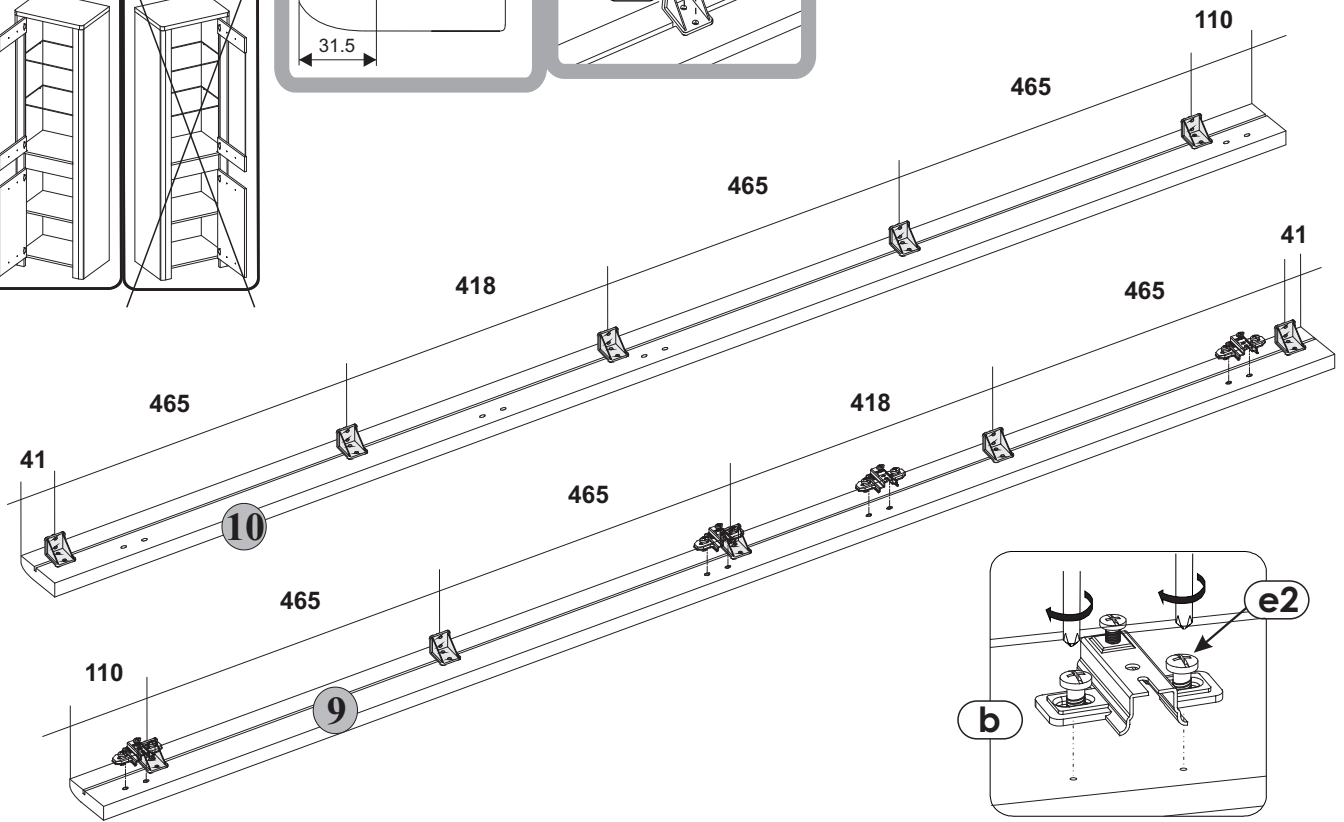

4

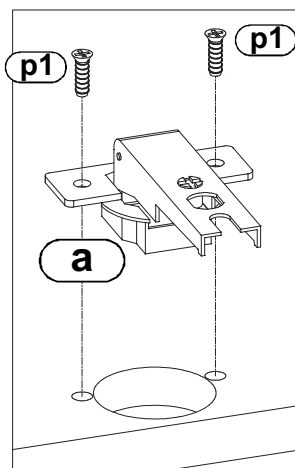
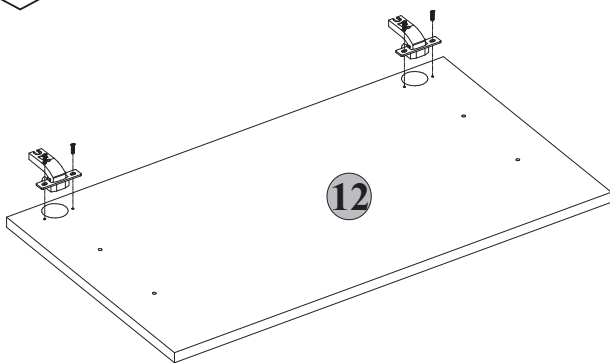

- a** x4
- p1** $\phi 3.5 \times 13$ mm x8

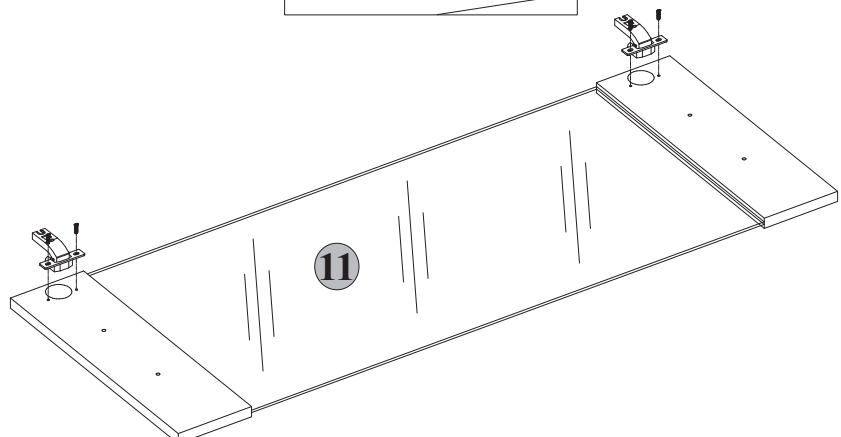
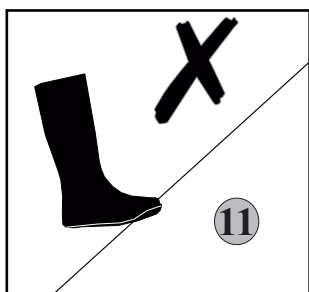

4

5

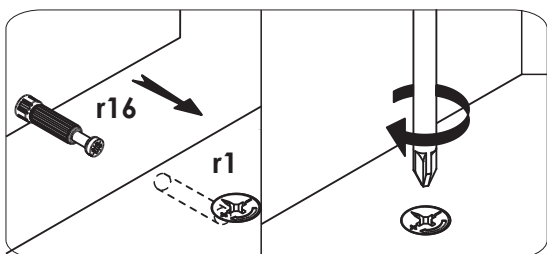
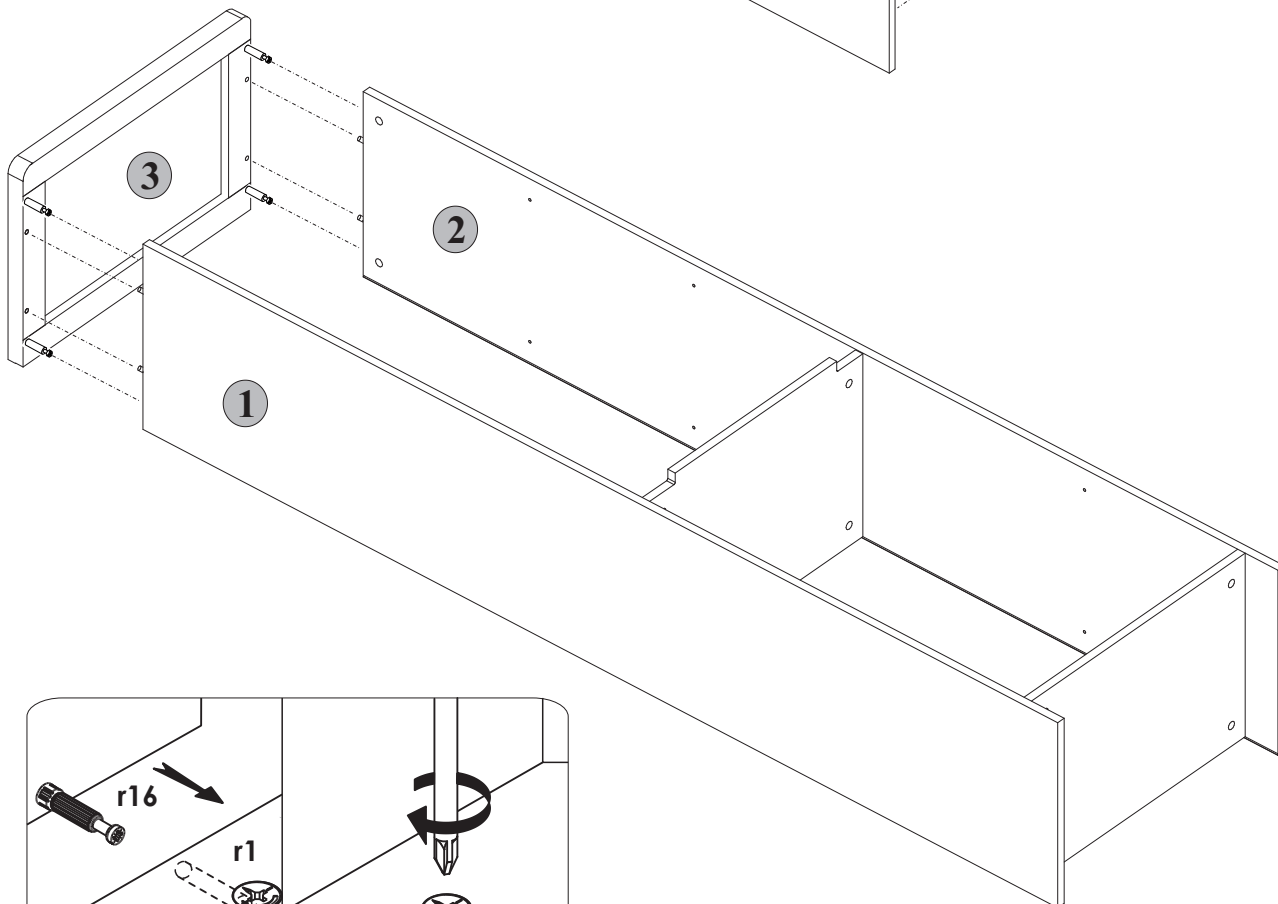
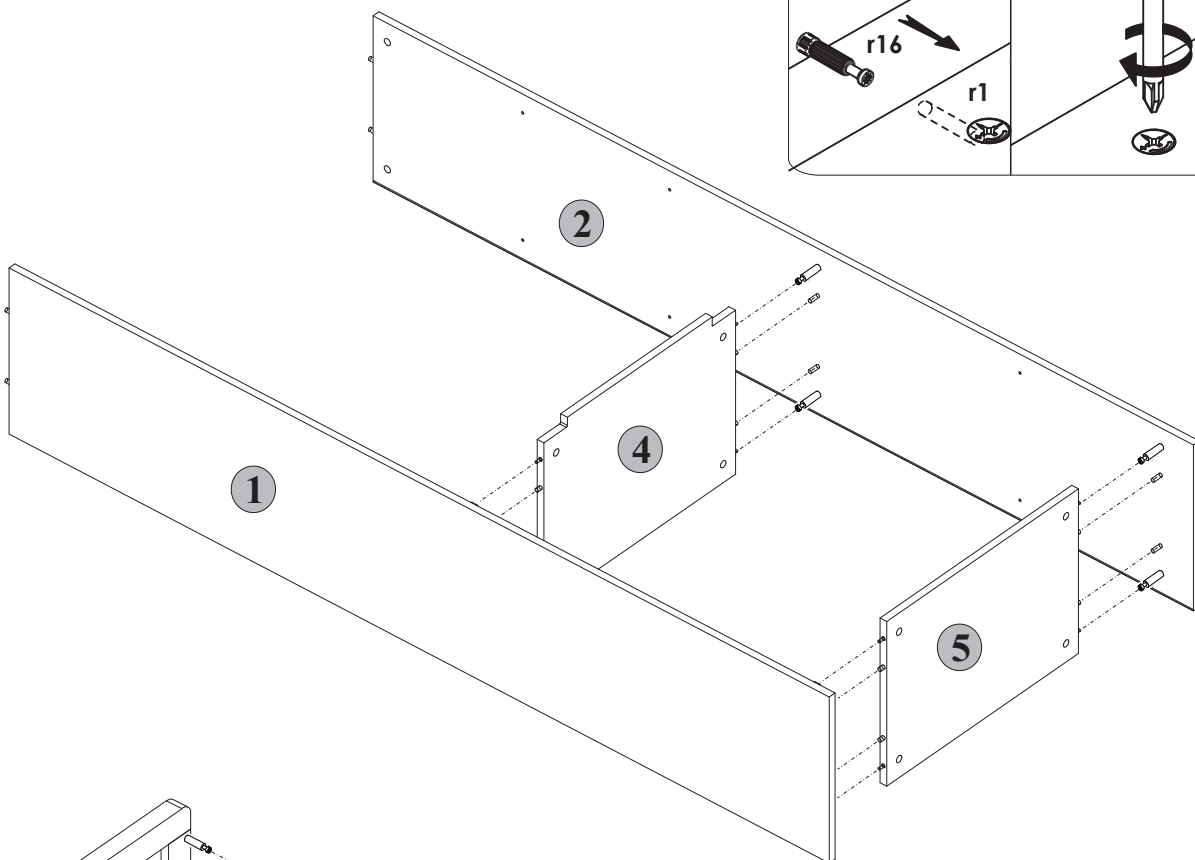
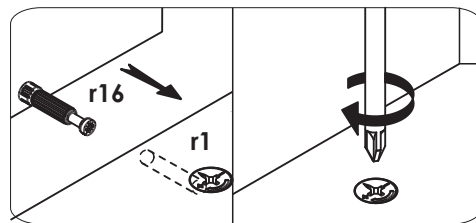
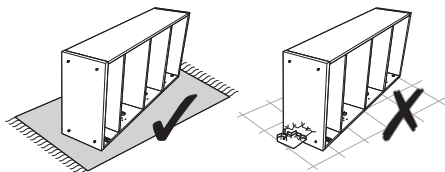

5

6

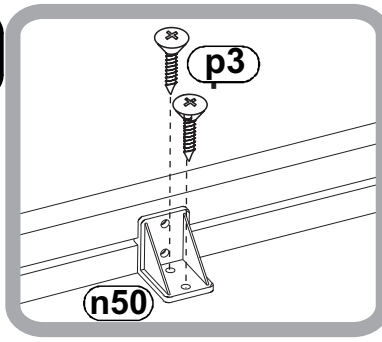

p3
φ3.5x16 mm x20

p78
φ3.5x30 mm x4

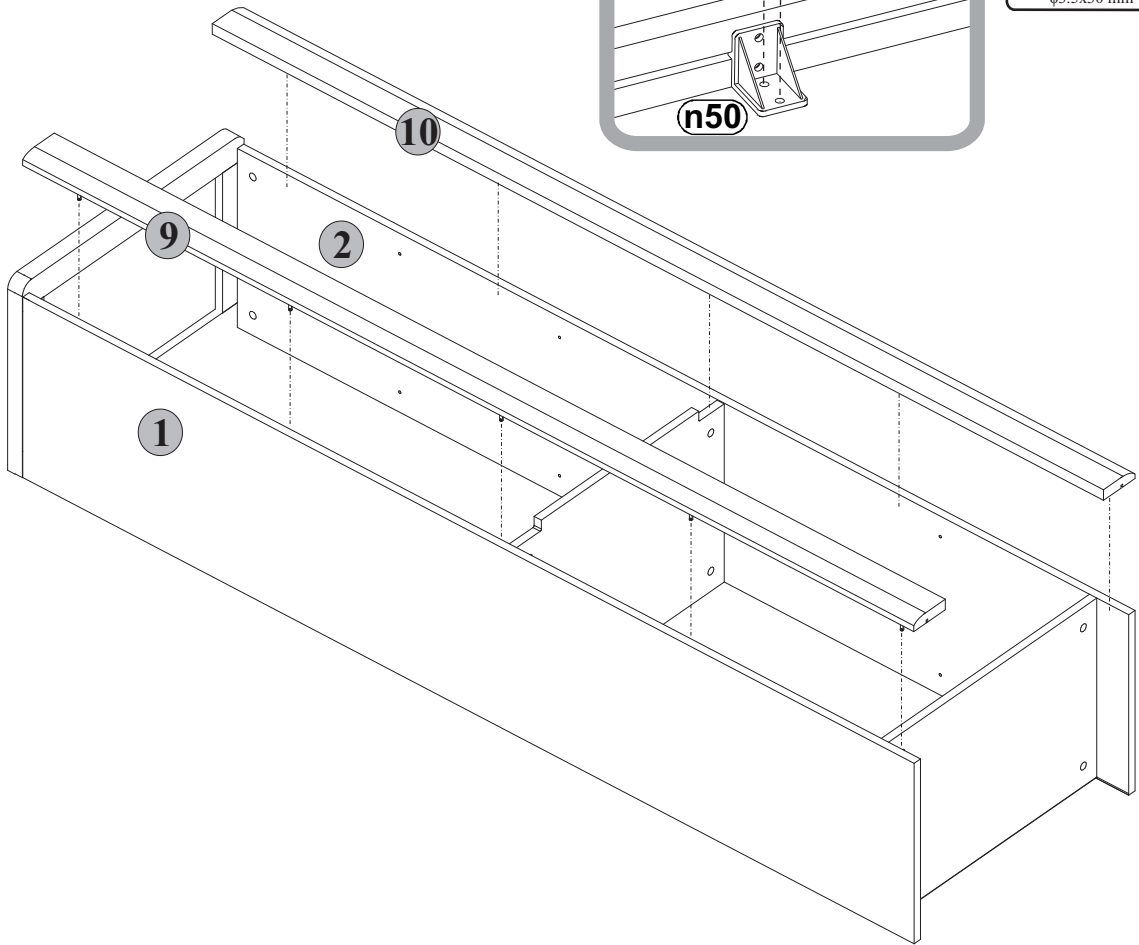

7

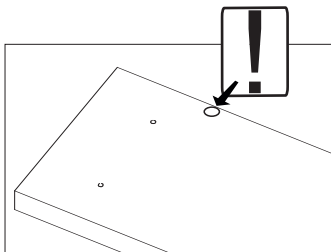
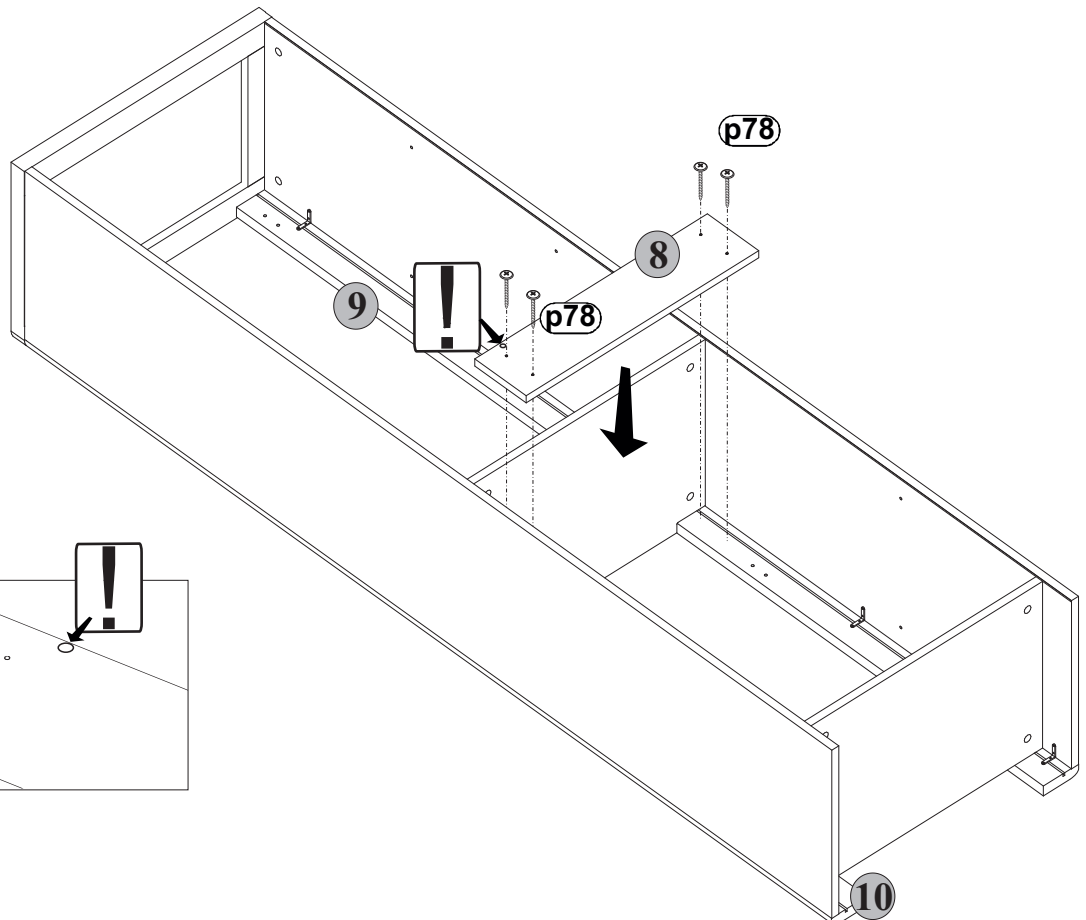

6

8

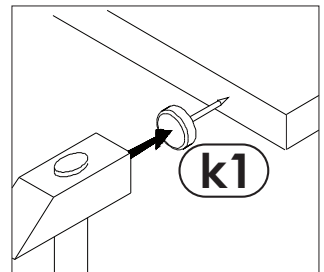
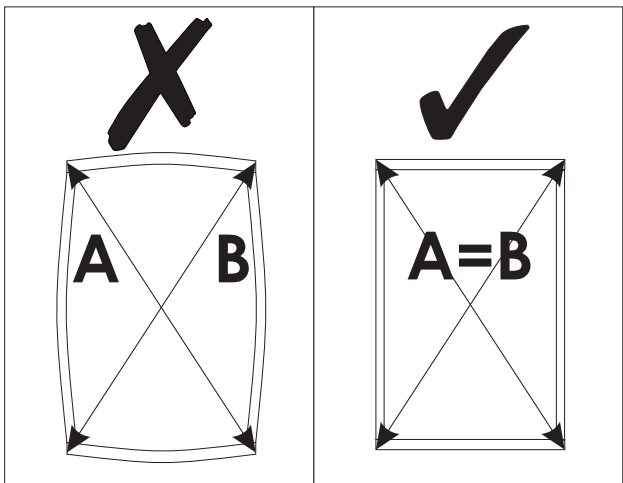
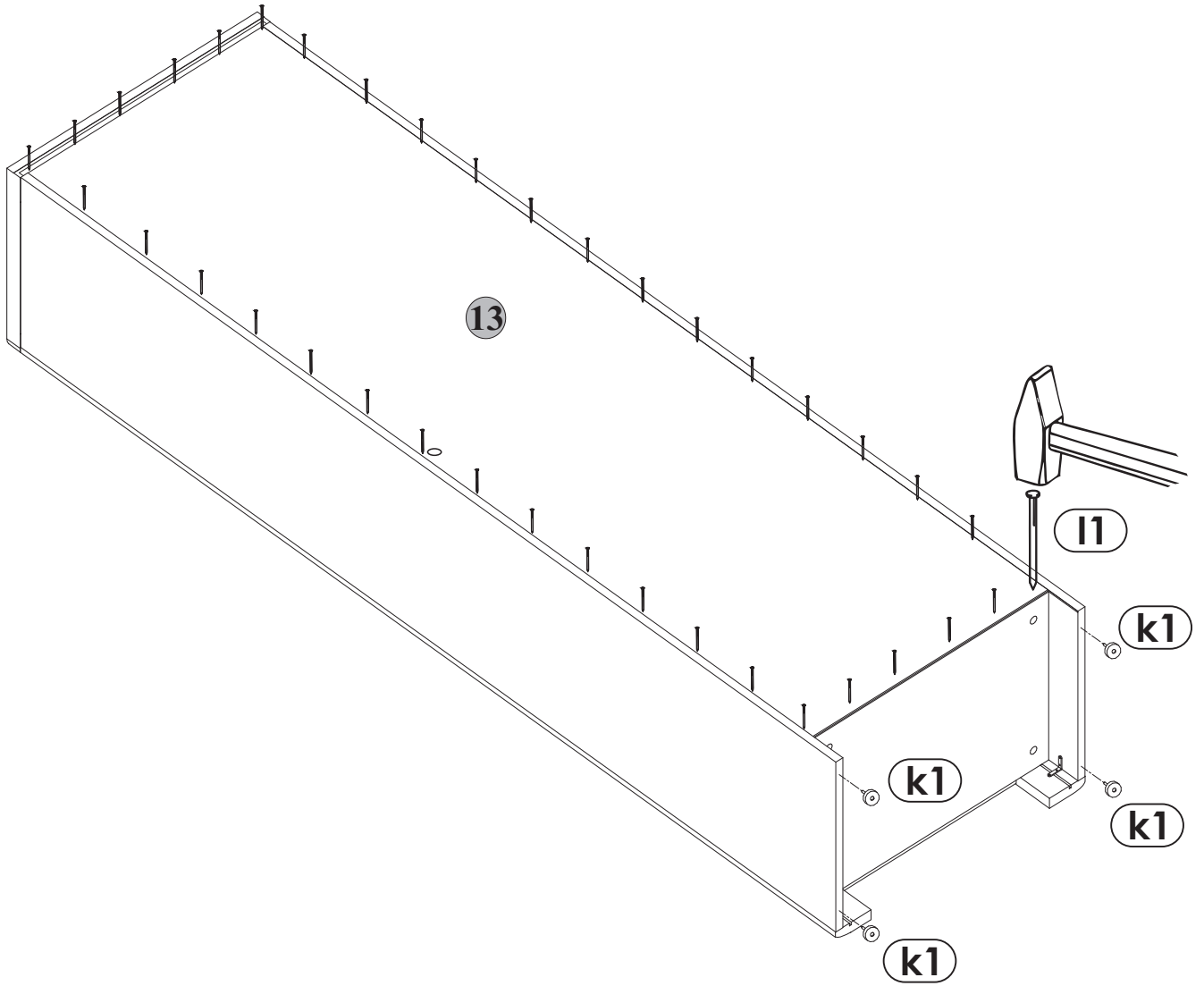
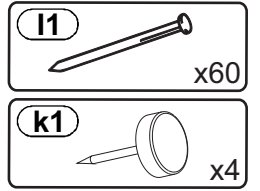



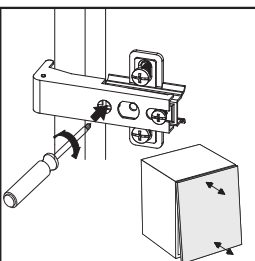
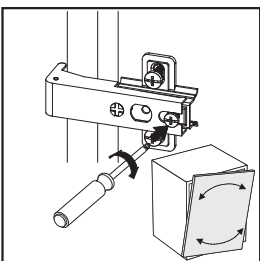
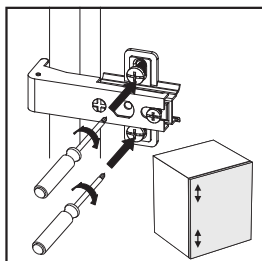
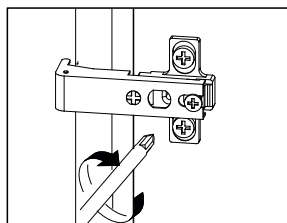
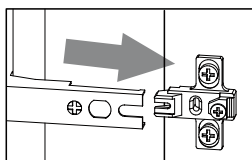
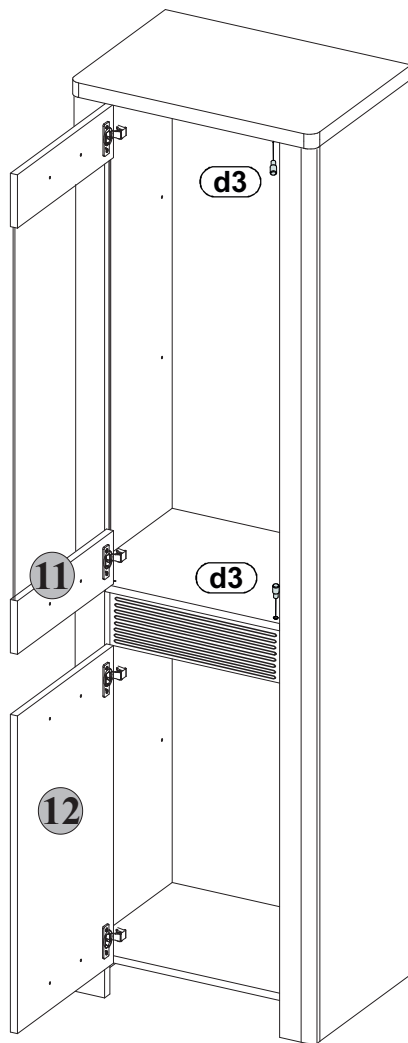
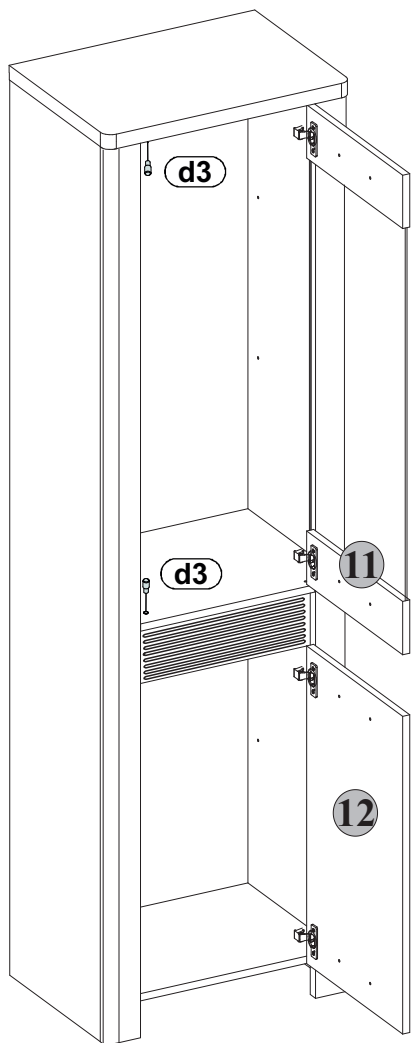
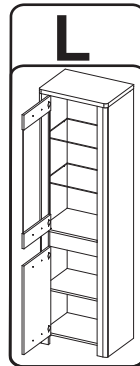
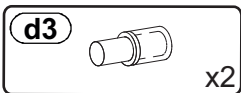
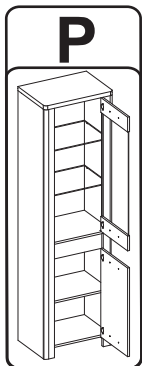

9



8

10

- c77**  x2
- j1**  $\phi 4 \times 25$ mm x4
- d3**  x8
- d1**  x4
- s2**  x18

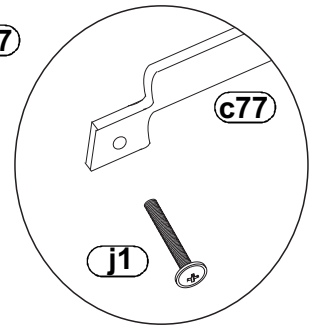
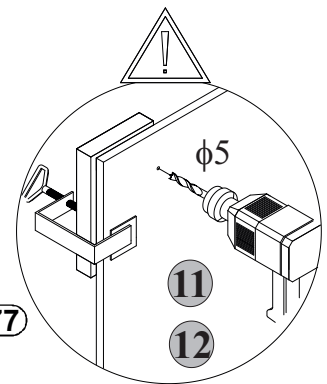
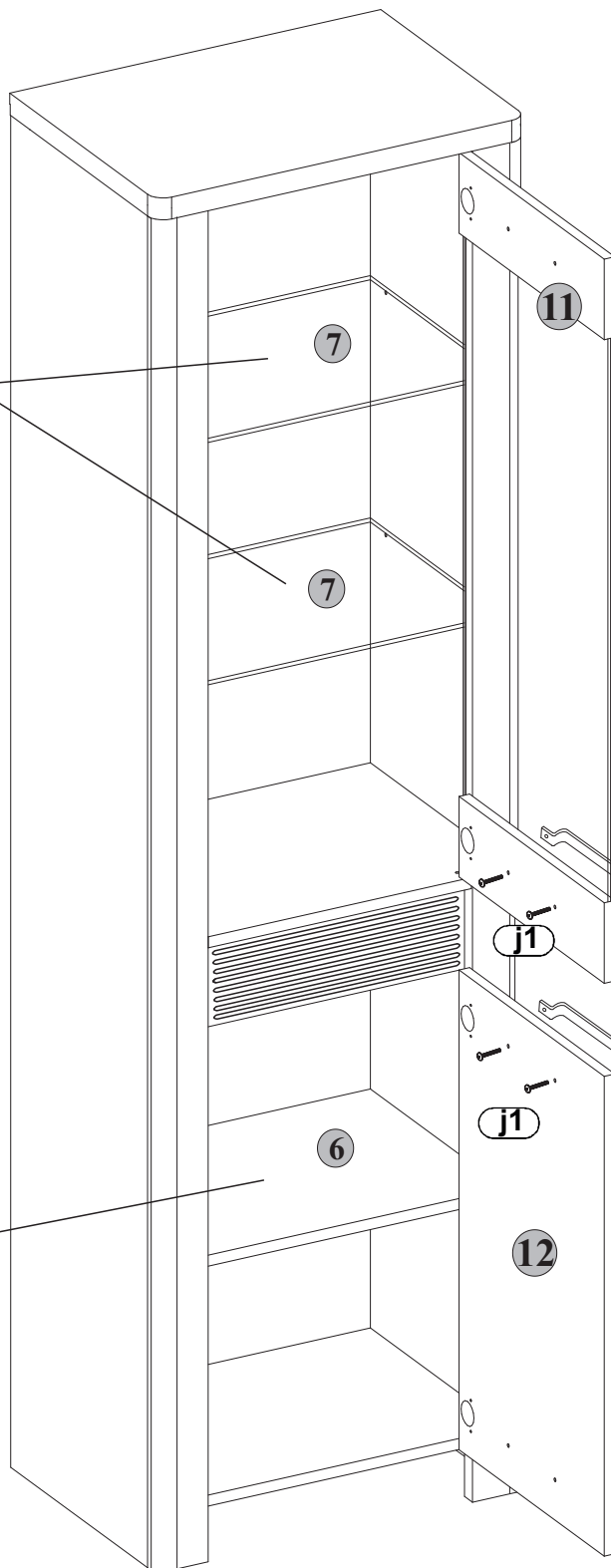
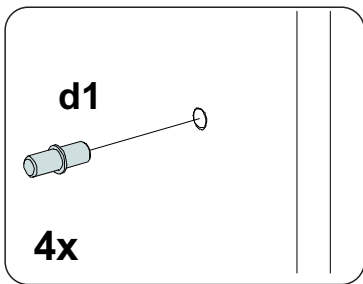
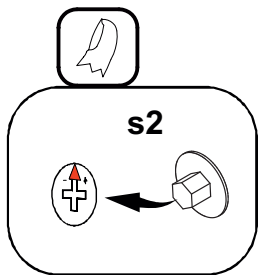
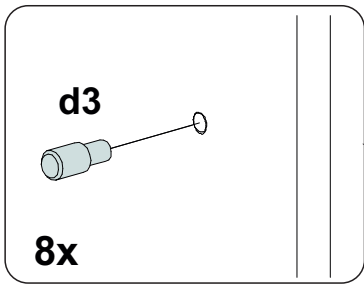

11

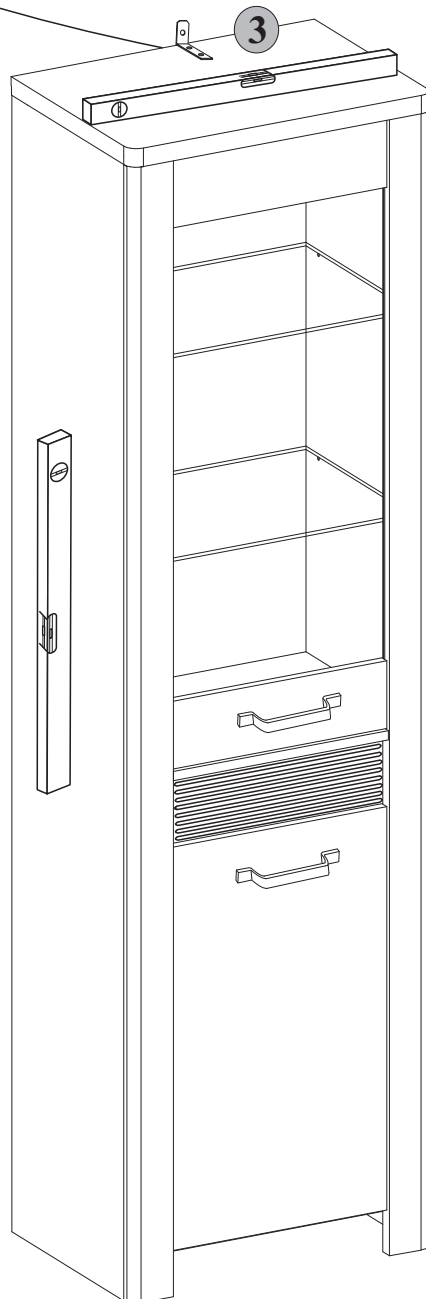
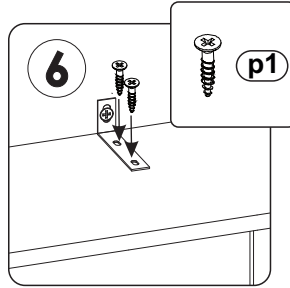
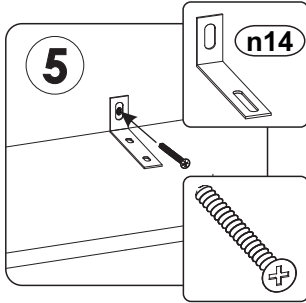
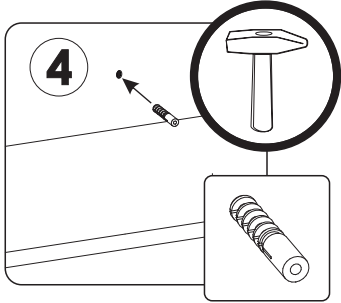
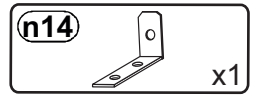
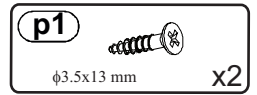
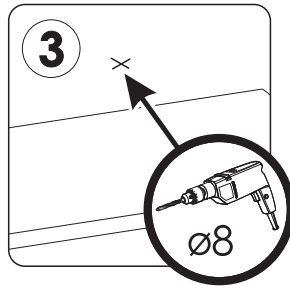
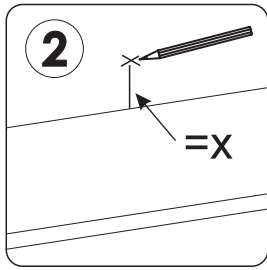
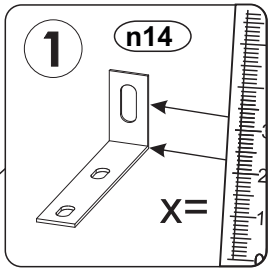

OPTION

Option

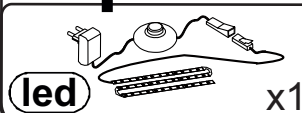

led x1

