

SONO

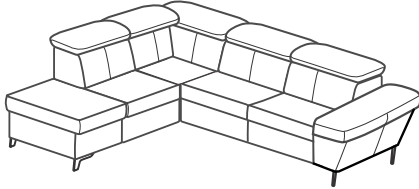

LEFT • GAUCHE • SINISTRA • LINKS •
 ESQUERDA • IZQUIERDA • LIJEVO • SOL
 • LEVO •



RIGHT • DROIT • DESTRA • RECHT •
 DIREITO • DERECHO • PRAVO • SAĞ
 • DESNO •

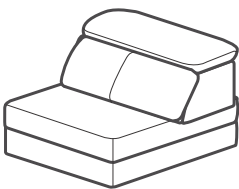
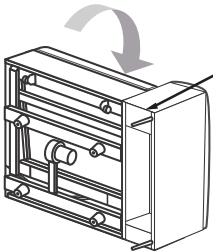
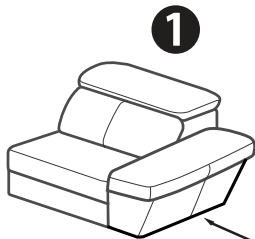
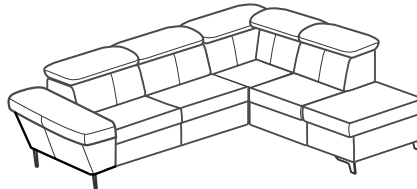

SAV ID LABEL

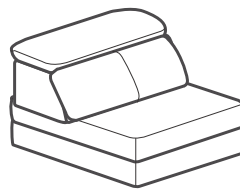
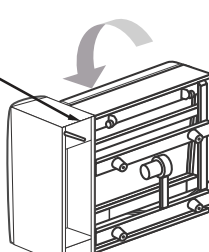
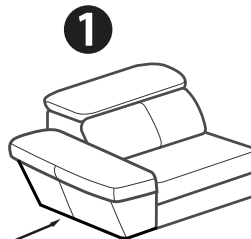

Attention ! Pour toute reclamation veuillez bien garder l'etiquette SAV collée au- dessous du meuble
Attenzione! Per favore conservate l'etichetta presente su ogni componente per eventuali reclami
Achtung! Unter dem Moebel befindet sich ein Etikett. Bitte bewahren das Etikett auf eine mögliche Reklamation
Attention! There is a label under every piece of furniture. Please keep it for possible complaints
Atención! Existe una etiqueta debajo de cada mueble. Por favor, quédensela para posibles futuras quejas
Atencao! Abaixo do móvel se encontra uma etiqueta. Por favor nao remova esta e mantem a etiqueta para qualquer reclamação
Važno! svaki proizvod ima svoju najljepnicu na dnu. Molimo vas da ju sačuvate za eventualne reklamacije
Dikkat önemli !
Bu etiketi lütfen çıkartmayınız. İleride oluşabilecek bir problem için saklayınız.
Bu bilgi bize problemin hızlı çözülmesi için gerekli olacaktır
Opresz! Ispod namještaja nalazi se naljepnica. Molimo vas da zadržite naljepnicu zbog moguće reklamacije
Opresz! Ispod nameštaja se nalazi nalepnica. Molimo vas da zadržite etiketu zbog moguće žalbe

AVANT DE COMMENCER, SE REPORTER AUX CONSEILS DE MONTAGE EN ANNEXE
BEFORE STARTING, REFER TO THE ASSEMBLING ADVICE IN ANNEX
PRIMA DI COMINCIARE VERIFICATE LE ISTRUZIONI DI MONTAGGIO
VOR DER MONTAGE, BITTE BEILIEGENDEN ANWEISUNGEN FOLGEN
ANTES DE COMERÇAR, ADIARSE AOS CONSELHOS DE MONTAGEM EM ANEXO
ANTES DE EMPEZAR CONSULTE LOS CONSEJOS PARA EL MONTAJE
PRIJE POČETKA MONTAŽE MOLIMO PAŽLJIVO PROČITAJTE UPUTE ZA MONTAŽU
BASLAMADAN ÖNCE EKTEKI KURULUM TALIMATLARINI OKUYUNUZ.
PRE MONTIRANJA, MOLIMO SLEDITE UPUTE.
PRE MONTIRANJA, MOLIMO SLEDITE UPUTE.

SONO

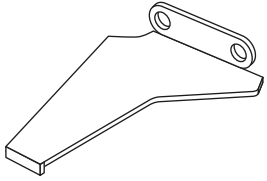

6x

A

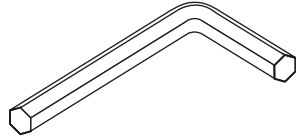

1x

B

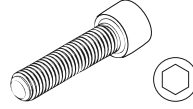

24x

C

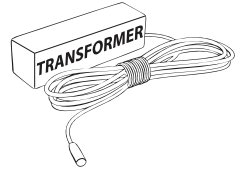

1x

D

1

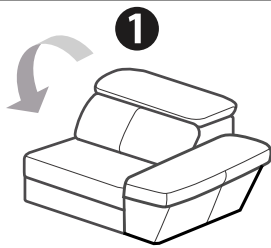

1

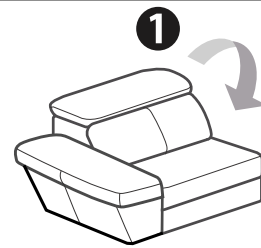

1

2

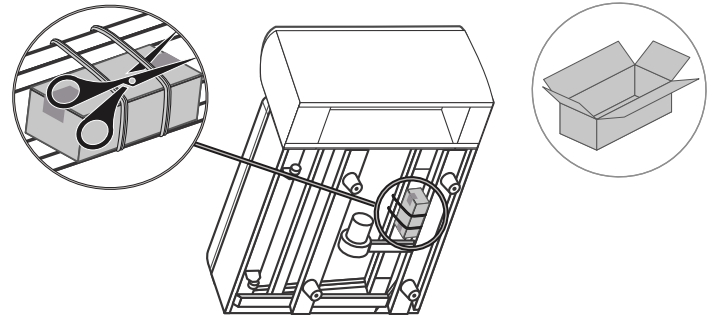
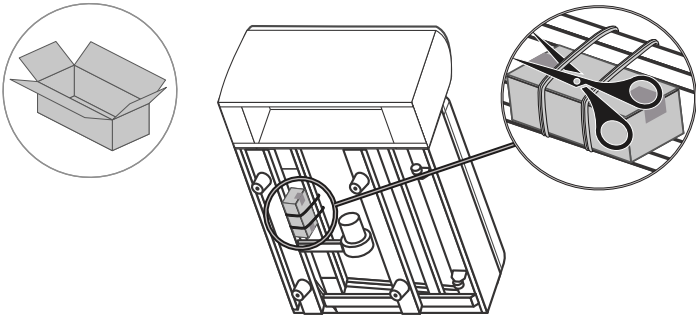

3

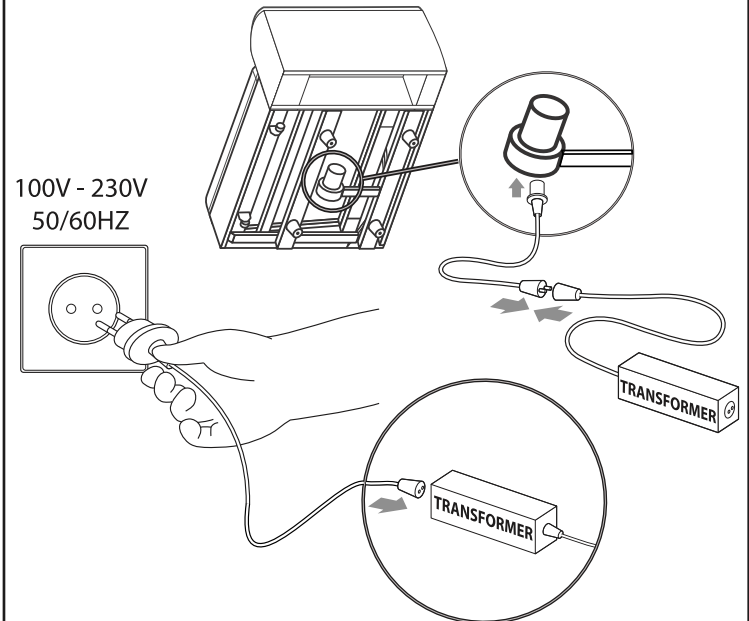
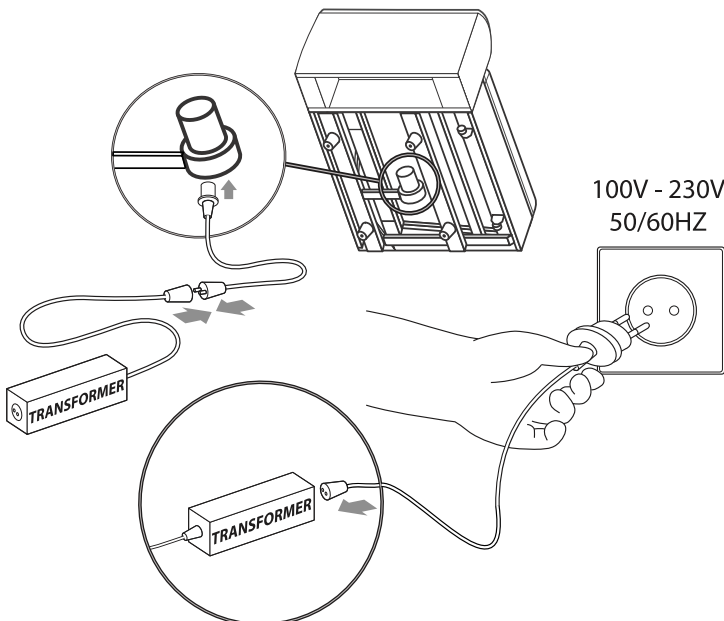

SONO



4

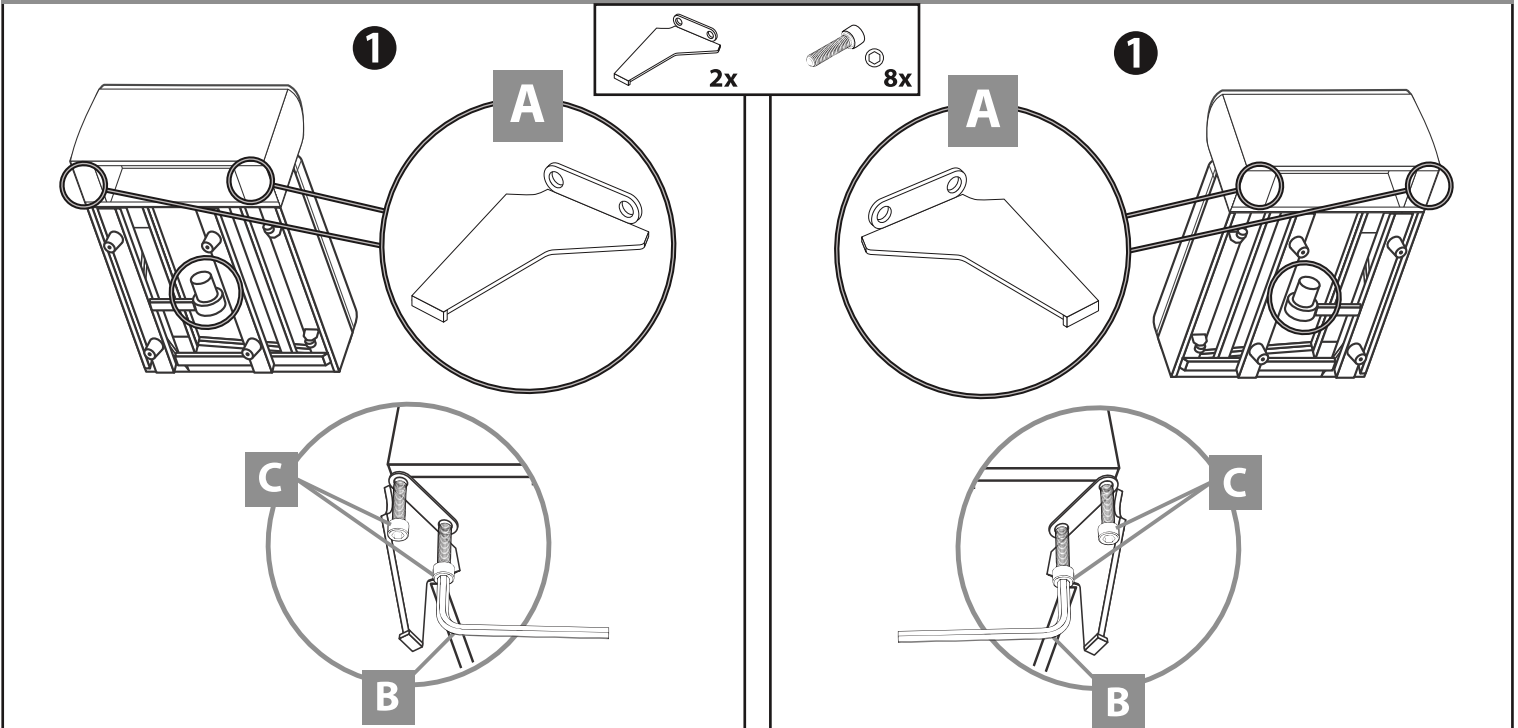

5

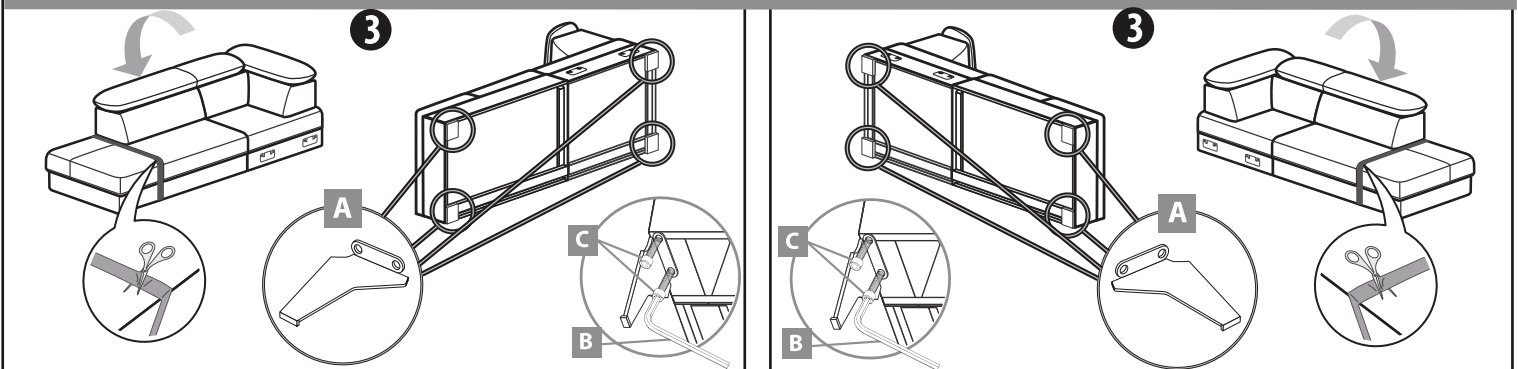

6

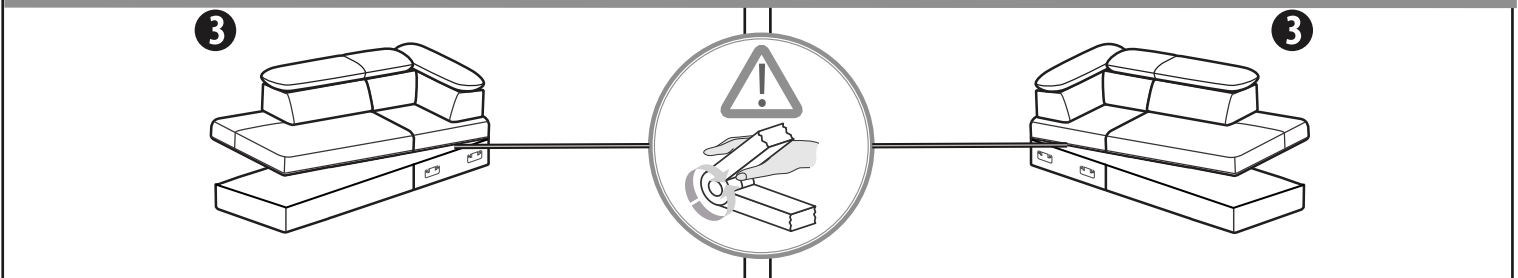

7

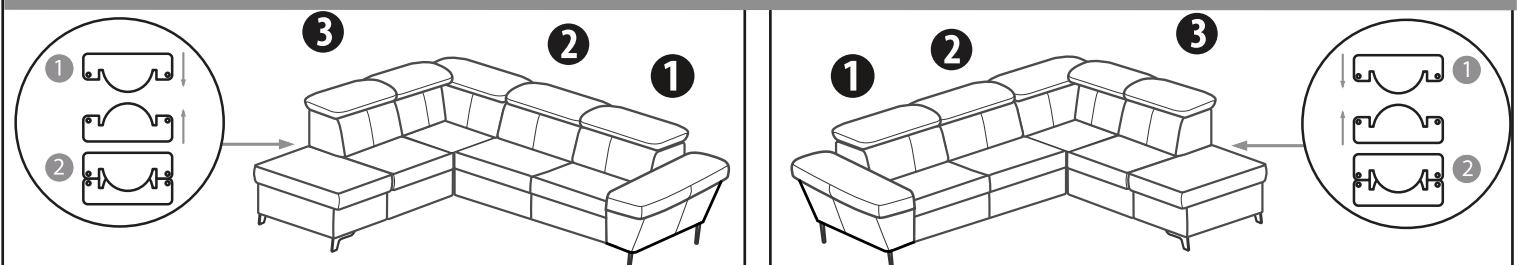

WARNING

- HU** Ez a modell egy hosszú és megerőltető utazás. Használat el. ráuuk fel, és érintse meg n. a pad megbirkózni Ez látszatát kelti elegancia és vonzerejét.
- POR** Este modelo tem uma viagem longa e extenuante. Antes de usá-lo, apertar e toque no teclado de lidar Isto dá a aparência de elegância e atratividade.
- FRA** Ce salon vient de faire un long voyages. Pour plus d'élégance et de volume, nous vous conseillons de secouer et de taper les coussins avec la main.
- ITA** Questo salotto ha appena fatto lunghi viaggi. Per più eleganza e volume, vi consigliamo di scuotere e batteere i cuscini.
- SPA** La sofa en el salyn es destina para descansar. Nosotros les recomendamos los cojinos para el aspecto más elegante.
- GB** This sofa has just made a long trip. For more elegance and volume, we advise you to shake and tap the cushions with your hand.
- DE** Dieses Sofa hat gerade eine lange Reise gemacht. Für mehr Eleganz und Volumen empfehlen wir Ihnen, die Kissen mit der Hand zu schütteln und zu klopfen.
- PL** Państwa sofa ma za sobą długą podróż. Proszę dobrze wygładzić rękoma poduszki w celu uzyskania odpowiedniego kształtu i objętości mebla
- HU** Minden egyes használat után, kérem tegye le a párnák.,
- POR** Após cada uso, por favor, colocar para baixo as almofada
- FRA** Renouveler ce procédé après chaque utilisation.
- ITA** Ciò procedere, deve essere rinnovare dopo ogni utilizzo.
- SPA** Despues cada uso hay que arreglar los cojinos.
- GB** Repeat this after every usage.
- DE** Wiederholen Sie dies nach jeder Verwendung.
- PL** Czynność tą należy regularnie powtarzać.

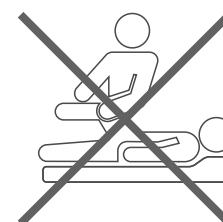
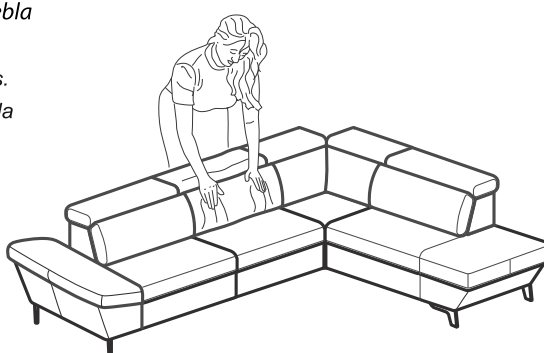
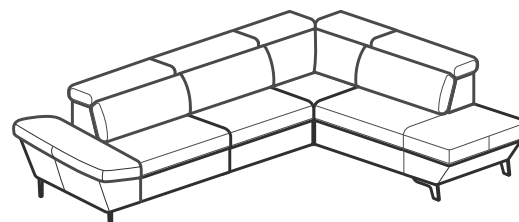
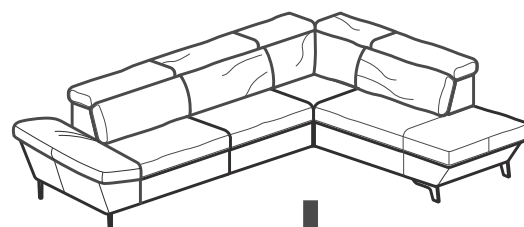

WARNING: Do not use this seat for people suffering of a physical handicap, and needing a seated continue and frequent position.
 -WARNING: This product shall be used in a frame of leisure or relaxation. This product does not comply with the norms in force for medical material.

ATTENTION: Ne pas utiliser ce siège pour des personnes souffrant d'un handicap physique et nécessitant la position assise continue et fréquente.

ATTENTION : Ce siège ne doit être utilisé que dans le cadre du loisir ou de la relaxation. Ce siège ne répond pas aux normes en vigueur du matériel médical.

WARNING: This appliance can be used by children aged from 8 years and above and persons with reduced physical, sensory or mental capabilities or lack of experience and knowledge if they have been given supervision or instruction concerning use of the appliance in a safe way and understand the hazards involved. Children shall not play with the appliance. Cleaning and user maintenance shall not be made by children without supervision.

ATTENTION: Cet appareil peut être utilisé par des enfants âgés d'au moins 8 ans et par des personnes ayant des capacités physiques, sensorielles ou mentales réduites ou dénuées d'expérience ou de connaissance, s'ils (si elles) sont correctement surveillé(e)s ou si des instructions relatives à l'utilisation de l'appareil en toute sécurité leur ont été données et si les risques encourus ont été appréhendés. Les enfants ne doivent pas jouer avec l'appareil. Le nettoyage et l'entretien par l'utilisateur ne doivent pas être effectués par des enfants sans surveillance.

ACHTUNG: Dieses Gerät kann von Kindern ab dem Alter von 8 Jahren und Personen mit eingeschränkten physischen, sensorischen oder geistigen Fähigkeiten und mangelnder Erfahrung und Kenntnissen verwendet werden, nur wenn sie die Aufsicht über den sicheren Umgang mit dem Gerät erhalten und die Gefahren verstanden haben. Kinder dürfen nicht mit dem Gerät spielen. Reinigung und Instandhaltung dürfen nicht von Kindern ohne Aufsicht durchgeführt werden.

UWAGA: Urządzenie to może być używane przez dzieci w wieku powyżej 8 lat. Osoby z ograniczonymi możliwościami fizycznymi, sensorycznymi lub umysłowymi jak również osoby bez doświadczenia i wiedzy mogą używać urządzenia jedynie pod nadzorem i po wcześniejszym zapoznaniu się z działaniem oraz zagrożeniami wynikającymi z użytkowania urządzenia. Dzieci nie mogą bawić się urządzeniem. Czyszczenie i konserwacja nie mogą być wykonywane przez dzieci bez nadzoru.

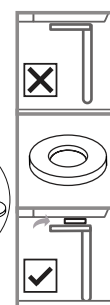
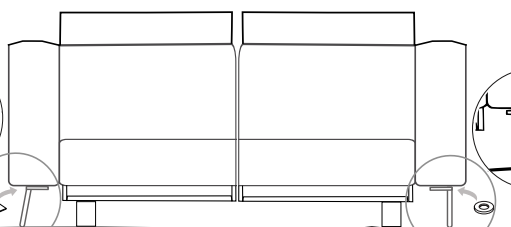
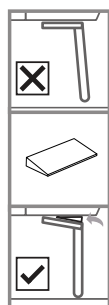
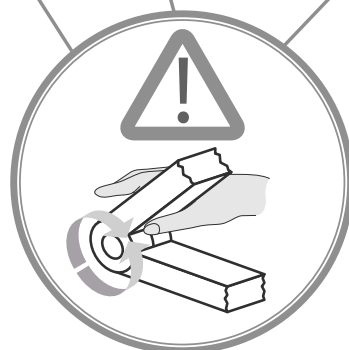
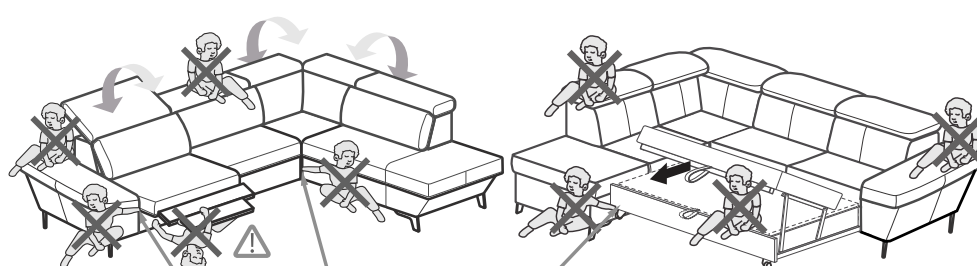

ENGLISH



NEVER FORCE THE CONNECTIONS. RE-TIGHTEN THE SCREWS AFTER FEW DAYS. PLEASE RETAIN THE AI LEAFLET FOR FUTURE REFERENCE. THE AI CONTAINS INFORMATION WHEN CLAIMING FOR MISSING PARTS.



NEVER USE ABRASIVE PRODUCTS OR SOLVENTS. DO NOT APPLY EXCESSIVE PRESSURE WHEN USING THE DAMP CLOTH.

ASSEMBLY ADVICE:

- 1 > CAREFULLY READ THE ASSEMBLY INSTRUCTION.
- 2 > IDENTIFY THE COMPONENTS OF THE FURNITURE.
- 3 > GROUP AND CHECK THE HARDWARE.
- 4 > USE THE REQUIRED TOOLS.
- 5 > CREATE AN ASSEMBLY ZONE.
- 6 > MAKE THE ASSEMBLY.
- 7 > FURNITURE WITH SLEEPING AND RELAXATION FUNCTIONS, BOXES (OPENING AND MOVABLE ELEMENTS) - HAVE LARGE OR SMALL TECHNICAL GAPS ON THE CONNECTION ELEMENTS.

	PAPER DECOR	LAMINATED SURFACES	LACQUERED SURFACES	VARNISHED WOOD	LEATHER TEXTILE
SOAPY WATER (NEUTRAL SOAP)	●	●	●	●	●
WATER WITH DETERGENT		●	●		
SPECIFIC SUPPLIER CLEARING					●

CLEANING ADVICE:

- 1 > CAREFULLY REMOVE THE DUST.
- 2 > USE A CLEAN, SOFT, DAMP CLOTH.
- 3 > (FABRIC FURNITURE) COMB THE WRINKLES CAUSED BY THE PACKAGING WITH A BRUSH.

DEUTSCH - SCHWEIZ



NIEMALS DIE VERBINDUNGEN ZU STARK ANZIEHEN. DIE SCHRAUBEN NACH EINIGER ZEIT DES GEBRAUCHS ERNEUT FESTZIEHEN. DIE MONTAGEANLEITUNG GUT AUFBEWAHREN: SOLLTE EIN TEIL FEHLEN, IST SIE DAS BESTE VERSTÄNDIGUNGSMITTEL MIT IHREM GESCHÄFT.



BENUTZEN SIE KEINE SCHEUERMITTEL WIE PULVER, STAHLWOLLE, LÖSUNGSMITTEL. KEIN WASSER VERWENDEN.

MONTAGE ANLEITUNG:

- 1 > DIE MONTAGEANLEITUNG SORGFÄLTIG DURCHLESEN.
- 2 > DIE EINZELTEILE DES MÖBELSTÜCKS ERMITTELN.
- 3 > DIE BESCHLÄGE ZUSAMMENLEGEN UND PRÜFEN.
- 4 > DAS NOTWENDIGE WERKZEUG ZURECHTLEGEN.
- 5 > EINEN MONTAGEBEREICH FREIMACHEN.
- 6 > DAS MÖBELSTÜCK ZUSAMMENBAUEN.
- 7 > DIE MÖBEL MIT SCHLAFFUNKTIONEN, RELAXFUNKTIONEN, BETTKÄSTEN (ÖFFENBARE UND BEWEGLICHE ELEMENTE) - BESITZEN AN DEN VERBINDELEMENTEN GRÖßERE ODER KLEINERE TECHNOLOGISCHEN SPALTEN.

	DEKORPAPIER	OBERFLÄCHE LAMINAT	OBERFLÄCHE LACK	LACKIERTEM HOLZ	TEXTIL LEDER
SEIFEN LAUGE (NEUTRALSEIFE)	●	●	●	●	●
WASSER MIT HAUSHALTSREINIGER		●	●		
PRODUZENT SPEZIFISCHER UNTERHALT					●

MONTAGE ANLEITUNG:

- 1 > SORGFÄLTIG ENTSTAUBEN.
- 2 > VERWENDEN SIE EIN SAUBERES, WEICHES, FEUCHTES TUCH.
- 3 > (MÖBEL AUS STOFF) KÄMMEN SIE MIT EINE BÜRSTE DIE DURCH DIE VERPACKUNG VERURSACHTEN FALTEN AUS.

FRANÇAIS - SUISSE



NE JAMAIS FORCER LES ASSEMBLAGES. RESSERREZ LES VIS APRES QUELQUES TEMPS D'USAGE. GARDER VOTRE NOTICE DE MONTAGE, SI UNE PIECE VENAIT A MANQUER, ELLE SERAIT LE PLUS CLAIR MOYEN DE COMMUNIQUER AVEC VOTRE MAGASIN.



NE JAMAIS UTILISER DE PRODUITS ABRASIFS: POUDRE, LAINE D'ACIER, SOLVANTS. NE PAS MOUILLER

CONSEILS DE MONTAGE:

- 1 > BIEN ETUDIER LA NOTICE DE MONTAGE.
- 2 > REPEREZ LES PIECES CONSTITUANT VOTRE MEUBLE.
- 3 > REGROUPEZ ET CONTROLEZ LA QUINCAILLERIE.
- 4 > MUNISSEZ-VOUS DE L'OUTILLAGE NECESSAIRE.
- 5 > AMENAGEZ-VOUS UNE ZONE DE MONTAGE.
- 6 > PROCEDEZ AU MONTAGE.
- 7 > MEUBLES AVEC FONCTIONS DE COUCHAGE ET DE RELAXATION, COFFRETS (ÉLÉMENTS OUVRANTS ET MOBILES) - ONT DES ECARTS TECHNIQUES GRANDS OU PETITS SUR LES ÉLÉMENTS DE CONNEXION.

	PAPIER DECOR	SURFACES STRATIFIÉES	SURFACES LAQUÉES	BOIS VERNIS	TEXTILE CUIR
EAU SAVONNEUSE (SAVON NEUTRE)	●	●	●	●	●
EAU ADDITIONNE		●	●		
ENTRETIEN SPÉCIFIQUE FABRICANT					●

CONSEILS D'ENTRETIEN:

- 1 > DÉPOUSSIÉREZ SOIGNEUSEMENT.
- 2 > UTILISEZ UN CHIFFON PROPRE, DOUX ET HUMIDE.
- 3 > (MOBILIER EN TISSU) PEIGNEZ LES RIDES CAUSÉES PAR L'EMBALLAGE AVEC UNE BROSSÉ.

POLSKI



NIĘ UŻYWAJ NADMIERNEJ SIŁY PODCZAS MONTAŻU. DOKRĘĆ ŚRUBY PO KILKU DNIACH. PROSZĘ ZACHOWAĆ ULOTKĘ AI NA PRZYSZŁOŚĆ, AI ZAWIERA INFORMACJE POTRZEBNE DO ZGŁOSZENIA BRAKUJĄCYCH CZĘŚCI.



NIGDY NIE UŻYWAJ PRODUKTÓW ŚCIERNYCH LUB ZAWIERAJĄCYCH ROZPUSZCZALNIKI. NIE NALEŻY NADMIERNIE POCIERAĆ POWIERZCHNI MEBLA PODCZAS UŻYWANIA ŚCIERKI.

WSKAZÓWKI MONTAŻOWE:

- 1 > NALEŻY DOKŁADNIE PRZECZYTAĆ INSTRUKCJĘ MONTAŻU.
- 2 > ZIDENTYFIKOWAĆ CZĘŚCI MEBLA.
- 3 > POGRUPUJ I SPRAWDŹ CZĘŚCI.
- 4 > UŻYJ WYMAGANYCH NARZĘDZI.
- 5 > STWÓRZ STREFĘ MONTAŻOWĄ.
- 6 > DOKONAJ MONTAŻU.
- 7 > MEBLE Z FUNKCJAMI SPANIA, RELAKSU, POJEMNIKAMI (ELEMENTY OTWIERANE-RUCHOME) - POSIADAJĄ NA ELEMENTACH ŁĄCZĄCYCH WIĘKSZE LUB MNIEJSZE SZCZELINY TECHNOLOGICZNE.

	DEKOR PAPIEROWY	POWIERZCHNIE LAMINOWANE	POWIERZCHNIE LAKIEROWANE	DREWNO LAKIEROWANE	SKÓRA TKANINA
WODA Z MYDŁEM (MYDŁO NEUTRALNE)	●	●	●	●	●
WODA Z DETERGENTEM		●	●		
CZYSZCZENIE PRODUKTEM DOSTAWCY					●

WSKAZÓWKI CZYSZCZENIA:

- 1 > DOKŁADNIE ZETRZYJ PYŁ.
- 2 > UŻYWAJ MIĘKKIEJ, CZYSTEJ, WILGOTNEJ ŚCIERKI.
- 3 > (MEBEL W TKANINIE) ZA POMOCĄ SZCZOTKI ROZCZESAĆ ZAGIĘCIA WYWOŁANE OPAKOWANIEM.

PORTUGUÊS



NUNCA FORÇAR OS ENCAIXES. REAPERTAR OS PARAFUSOS APÓS UM TEMPO DE UTILIZAÇÃO. GUARDARAS INSTRUÇÕES DE MONTAGEM. CASO FALTE ALGUMA PEÇA, O MAIS ACONSELHÁVEL É CONTATAR O REVENDEDOR.



NUNCA UTILIZAR PRODUTOS ABRASIVOS: SAPONÁCEOS, LÃ DE AÇO, SOLVENTES. NÃO MOLHAR.

CONSELHOS DE MONTAGEM:

- 1 > ESTUDE BEM AS INSTRUÇÕES DE MONTAGEM.
- 2 > REUNA AS PEÇAS QUE CONSTITUEM O SEU MÓVEL.
- 3 > REAGRUPE AS FERRAGENS.
- 4 > EQUIPE-SE COMAS FERRAMENTAS NECESSÁRIAS.
- 5 > PREPARE UMA ÁREA PARA A MONTAGEM.
- 6 > INICIE A MONTAGEM.
- 7 > MÓVEIS COM FUNÇÕES DE DORMIR E RELAXAR, CAIXAS (ELEMENTOS MÓVEIS E DE ABERTURA) - APRESENTAM GRANDES OU PEQUENAS LACUNAS TÉCNICAS NOS ELEMENTOS DE CONEXÃO.

	ACABAMENTO IMITAÇÃO	SUPERFÍCIES ESTRATIFICADAS	SUPERFÍCIES LAÇADAS	MADEIRA ENVERNIZADA	TEXTÉIS PELES
ÁGUA COM SABÃO (SABÃO NEUTRO)	●	●	●	●	●
ÁGUA COM DETERGENTE		●	●		
INSTRUÇÕES ESPECÍFICAS DO FABRICANTE					●

CONSELHOS PARA A MANUTENÇÃO:

- 1 > ELIMINAR BEM O PO.
- 2 > USE UM PANO LIMPO, MACIO E ÚMIDO.
- 3 > (MÓVEIS DE TECIDO) PENTEIE AS RUGAS CAUSADAS PELA EMBALAGEM COM UM PINCEL.

ITALIANO - SVIZZERA



NON FORZARE MAI GLI ASSEMBLAGGI RISTRINGERE LE VITI DOPO UN PERIODO D'USO CONSERVARE QUESTE ISTRUZIONI DI MONTAGGIO, SE UN PEZZO VENISSE A MANCARE SAREBBE IL MIGLIORE MEZZO DI COMUNICAZIONE CON IL RIVENDITORE.



NON UTILIZZARE MAI PRODOTTI ABRASIVI: POLVERE, LANA DI ACCIAIO, SOLVENTI. NON BAGNARE.

CONSIGLI DI MONTAGGIO:

- 1 > STUDIARE BENE LE ISTRUZIONI DI MONTAGGIO.
- 2 > PRENDERE CONOSCENZA DEI PEZZI CHE COSTITUISCONO IL MOBILE.
- 3 > RAGGRUPPARE E CONTROLLARE LA FERRAMENTA.
- 4 > MUNIRSI DEGLI UTENSILI NECESSARI.
- 5 > PREPARARE UNA ZONA DI MONTAGGIO.
- 6 > PROCEDERE AL MONTAGGIO.
- 7 > MOBILI CON FUNZIONI PER DORMIRE E RILASSARSI, SCATOLE (ELEMENTI APRIBILI E MOBILI) - PRESENTANO AMPI O PICCOLI SPAZI TECNICI SUGLI ELEMENTI DI CONNESSIONE.

	CARTA	SUPERCIE STRATIFICATE	SUPERFICIE LACCATE	LACCATE EGNO VERNICIATO	TESSILE CUOIO
ACQUA CON SAPONE (SAPONE NEUTRO)	●	●	●	●	●
ACQUA CON DETERSIVO SAN MARC		●	●		
MANUTENZIONE SPECIFICA PRODUTTORE					●

CONSIGLI PER LA MANUTENZIONE:

- 1 > SPOLVERATE ACCURATAMENTE.
- 2 > UTILIZZARE UN PANNINO PULITO, MORBIDO E UMIDO.
- 3 > (MOBILI IN TESSUTO) PETTINARE LE RUGHE CAUSATE DALLA CONFEZIONE CON UN PENNELLO.

ESPAÑOL



NO FUERCE NUNCA EN LAS UNIONES. APRIETE LOS TORNILLOS DESPUES DE CIERTO TIEMPO DE UTILIZACION CONSERVE SU MANUAL DE MONTAJE, SI FALTARA UNA PIEZA. SERIA LA MANERA MAS FACIL DE COMUNICAR CON LA TIENDA.



NO USE NUNCA PRODUCTOS ABRASIVOS TALES COMO: POLVO DE LIMPIAR, LANA DE ACERO, SOLVENTES. NO MOJAR.

CONSEJOS PARA EL MONTAJE:

- 1 > ESTUDIE ATENTAMENTE EL MANUAL DE MONTAJE.
- 2 > LOCALICE LAS PIEZAS QUE CONSTITUYEN SU MUEBLE.
- 3 > REUNA Y CONTROLE LOS TORNILLOS.
- 4 > EQUIPE-SE DE LAS HERRAMIENTAS NECESARIAS.
- 5 > PREPARE UNA ZONA DE MONTAJE.
- 6 > REALICE EL MONTAJE.
- 7 > MUEBLES CON FUNCIONES DE DESCANSO Y DESCANSO, CAJAS (ELEMENTOS MÓVILES Y DE APERTURA): TIENEN ESPACIOS TÉCNICOS GRANDES O PEQUEÑOS EN LOS ELEMENTOS DE CONEXIÓN.

	PAPEL DE DECORACION	SUPERFICIE ESTRATIFICADAS	SUPERFICIE MAQUEADAS	MADERA BARNIZADA	TEXULL CUERO
AGUA Y JABON (JABON NEUTRO)	●	●	●	●	●
AGUA COM DETERGENTE		●	●		
MANTENIMIENTO ESPECIFICO DEL FABRICANTE					●

CONSEJOS PARA EL MANTENIMIENTO:

- 1 > DESPOLVOREAR CUIDADOSAMENTE.
- 2 > USE UN PAÑO LIMPIO, SUAVE Y HÚMEDO.
- 3 > (MUEBLES DE TELA) PEINE LAS ARRUGAS CAUSADAS POR EL EMBALAJE CON UN CEPILLO.

HRVATSKA



NEMOJTE UPOTREBLJAVATI SILU PRILIKOM SKLAPANJA NAKON NEKOG VREMENA PONOVNO PRITEGNITE VIJKE ČUVAJTE UPUTE ZA MONTAŽU U SLUČAJU NEDOSTATKA NEKOG DIJELA NAJBOLJE ĆE BITI DA DA KONTAKIRATE PRODAJNO MJESTO.



ZABRANJENA JE UPOTREBA KEMIKALIJA ILI BILO KAKVIH POMOĆNIH SREDSTAVA ZA RIBANJE JAKIH SREDSTAV ZA ČIŠĆENJE ILI ČELIČNE VUNE NE MOKRA.

UPUTE ZA MONTAŽU:

- 1 > PAŽLJIVO PROČITAJTE UPUTE ZA MONTAŽU.
- 2 > PRIPREMITE SVE DIJELOVE NAMJEŠTAJA.
- 3 > PRIKUPITE I PROVJERITE OKOVE ZA MONTAŽU.
- 4 > PRIPREMITE POTREBAN ALAT.
- 5 > PRIPREMITE PROSTOR ZA MONTAŽU.
- 6 > POČNITE MONTIRATI.
- 7 > NAMJEŠTAJ S FUNKCIJAMA SPAVANJA I OPUŠTANJA, KUTIJE (OTVORNI I POMIČNI ELEMENTI) - IMAJU VEĆE ILI MANJE TEHNIČKE PRAZNE NA SPOJNIM ELEMENTIMA.

	PAPIR	LAMINAT	LAK	DRVO	TEKSTIL/ KOŽA
OTPINA SAPUNA	●	●	●	●	●
OTPINA SAPUNA		●	●		
NAMJENSKA SREDSTVA					●

UPUTE ZA ODRŽAVANJE:

- 1 > PAŽLJIVO OBRISATI PRAŠINU.
- 2 > KORISTITE ČISTU, MEKU, VLAŽNU KRPU.
- 3 > (NAMJEŠTAJ OD TKANINE) KISTOM ČEŠLJAJTE BORE NASTALE NA PAKIRANJU.

TÜRKÇE



MONTAJLARI ZORLAMAYINIZ BİRKAÇ KULLANIMDAN SONRA VIDALARI SIKIŞTIRINIZ BİR PARÇANIN KAYBOLMASI DURUMUNDA MAĞAZANIZLADAKİ KOLAY İLETİŞİME GEÇEBİLMENİZ İÇİN MONTAJ KULLANIM TALİMATINI SAKLAYINIZ.



ASLA AŞINDIRICI ÜRÜNLER KULLANMAYINIZ: ÇELİK YÜNÜ SOLVENT BOL SUYLA YIKAMAYINIZ.

MONTAJ TALİMATLARI:

- 1 > MONTAJ TANITIM YAZISINI DİKKATLİCE OKUYUNUZ.
- 2 > MOBİLYANIZI OLUŞTURAN PARÇALARI İŞARETLEYİNİZ.
- 3 > HIRDAVATLA İLGİLİ PARÇALARI BİR ARAYA TOPLAYIP KONTROL EDİNİZ.
- 4 > GEREKEN ARAÇ VE GEREÇİ TEDARİK EDİNİZ.
- 5 > (KENDİNİZE) BİR MONTAJ ALANI EDİNİNİZ.
- 6 > MONTE ELMEYE BAŞLAYINIZ.
- 7 > UYKU VE RAHATLAMA FONKSİYONLU MOBİLYALAR, KUTULAR (AÇMA VE HAREKET ETTİRİLEBİLİR ELEMANLAR) - BAĞLANTI ELEMANLARINDA BÜYÜK VEYA KÜÇÜK TEKNİK BOŞLUKLAR VARDIR.

	SÜS KAĞIDI	KATMAN YÜZEY	LAKE YÜZEY	LAKE YÜZEY	TEKSTİL DERİ
SABUNLU SU (NÖTR SABUN)	●	●	●	●	●
DETERJAN KATILMIŞ SU		●	●		
ÜRETİCİYE ÖZGÜ BAKIM					●

BAKIM TALİMATLARI:

- 1 > TOZUNU DİKKATLİCE ALINIZ.
- 2 > TEMİZ, YUMUŞAK, NEMLİ BİR BEZ KULLANIN.
- 3 > KUMAŞ MOBİLYA) AMBALAJIN NEDEN OLDUĞU KIRIŞIKLIKLARI FIRÇA İLE TARAKLAYIN.

SRBIJA



NEMOJTE UPOTREBLJAVATI SILU PRILIKOM SKLAPANJA NAKON NEKOG VREMENA PONOVO PRITEGNITE ŠRAFOVE, ČUVAJTE UPUTSTVA ZA MONTAŽU, U SLUČAJU NEDOSTATKA NEKOG DELA NAJBOLJE JE DA KONTAKIRATE PRODAJNO MESTO.



ZABRANJENA UPOTREBA HEMIKALIJA ILI BILO KAKVIH POMOĆNIH SREDSTAVA ZA RIBANJE JAKIH SREDSTAV ZA ČIŠĆENJE ILI ČELIČNE VUNE NE MOKRA.

SAVETI ZA MONTAŽU:

- 1 > PAŽLJIVO PROČITAJTE UPUTSTVA ZA MONTAŽU.
- 2 > PROVERITE DA LI IMATE SVE DELOVE.
- 3 > SAKUPITE I PROVERITE OKOVE ZA MONTAŽU.
- 4 > PRIPREMITE POTREBAN ALAT.
- 5 > PRIPREMITE PROSTOR ZA MONTAŽU.
- 6 > POČNITE DA MONTIRATE.
- 7 > SAČUVAJTE OVA UPUTSTVA.
- 8 > PROIZVOD JE NAMJENJEN ISKLJUČIVO ZA KUĆNU UPOTREBU.
- 9 > NAMEŠTAJ SA FUNKCIJAMA SPAVANJA I OPUŠTANJA, KUTIJE (OTVORNI I POKRETNI ELEMENTI) - IMAJU VEĆE ILI MANJE TVORNIČKE PRAZNE NA PRIKLJUČNIM ELEMENTIMA.

	HARTIJA	LAMINAT	LAK	DRVO	TEKSTIL/ KOŽA
RASTVOR SAPUNA	●	●	●	●	●
RASTVOR DETERDŽENTA		●	●		
NAMJENSKA SREDSTVA					●

UPUTSTVA ZA ODRŽAVANJE:

- 1 > PAŽLJIVO OBRISATI PRAŠINU.
- 2 > KORISTITE ČISTU, MEKU, VLAŽNU KRPU.
- 3 > (NAMJEŠTAJ OD TKANINE) KISTOM ČEŠLJAJTE BORE NASTALE NA PAKIRANJU.