

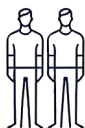

1

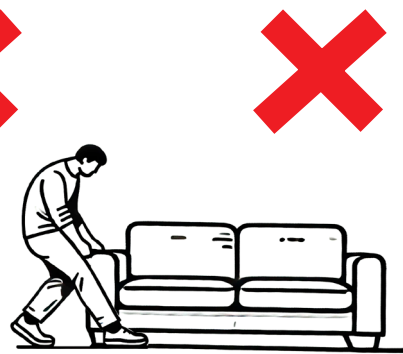

2

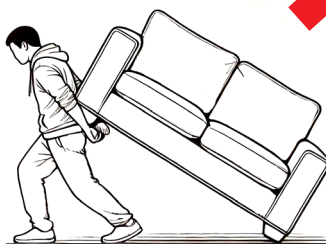
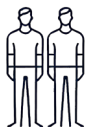

3

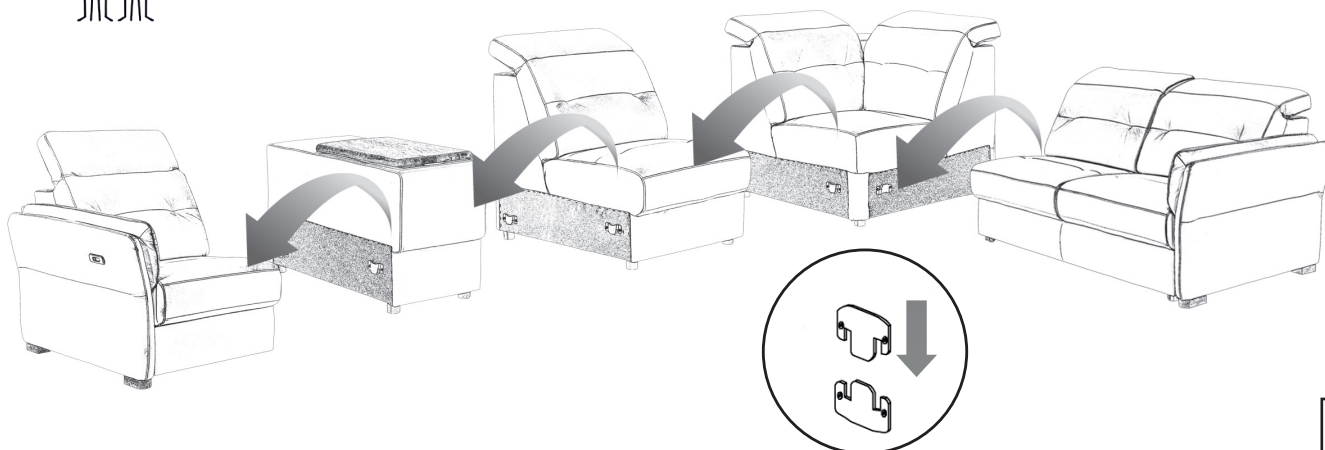
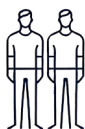

4

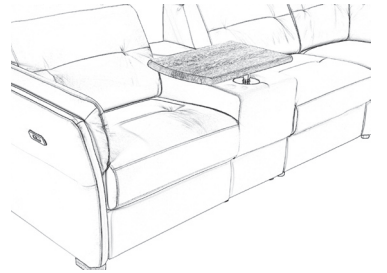
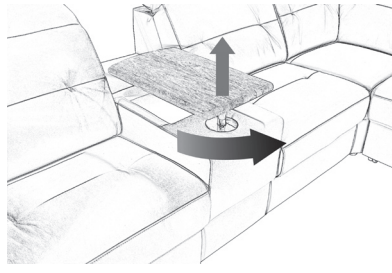
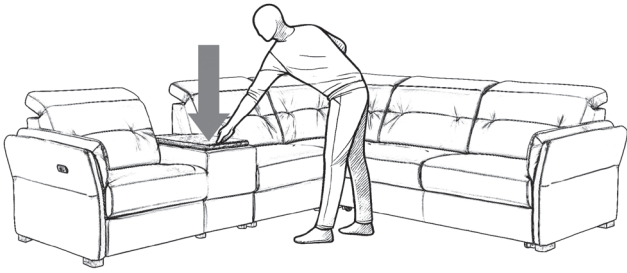

5

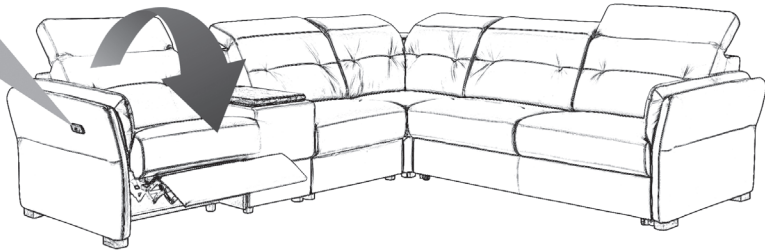
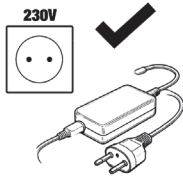

6

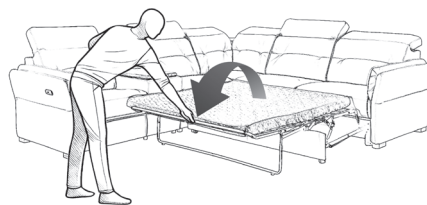
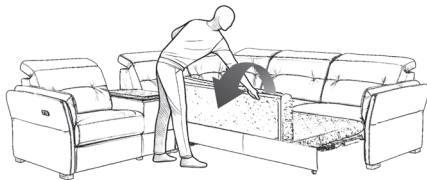

7

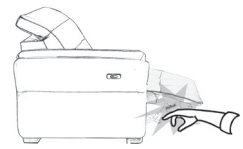
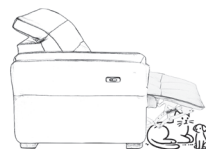

8

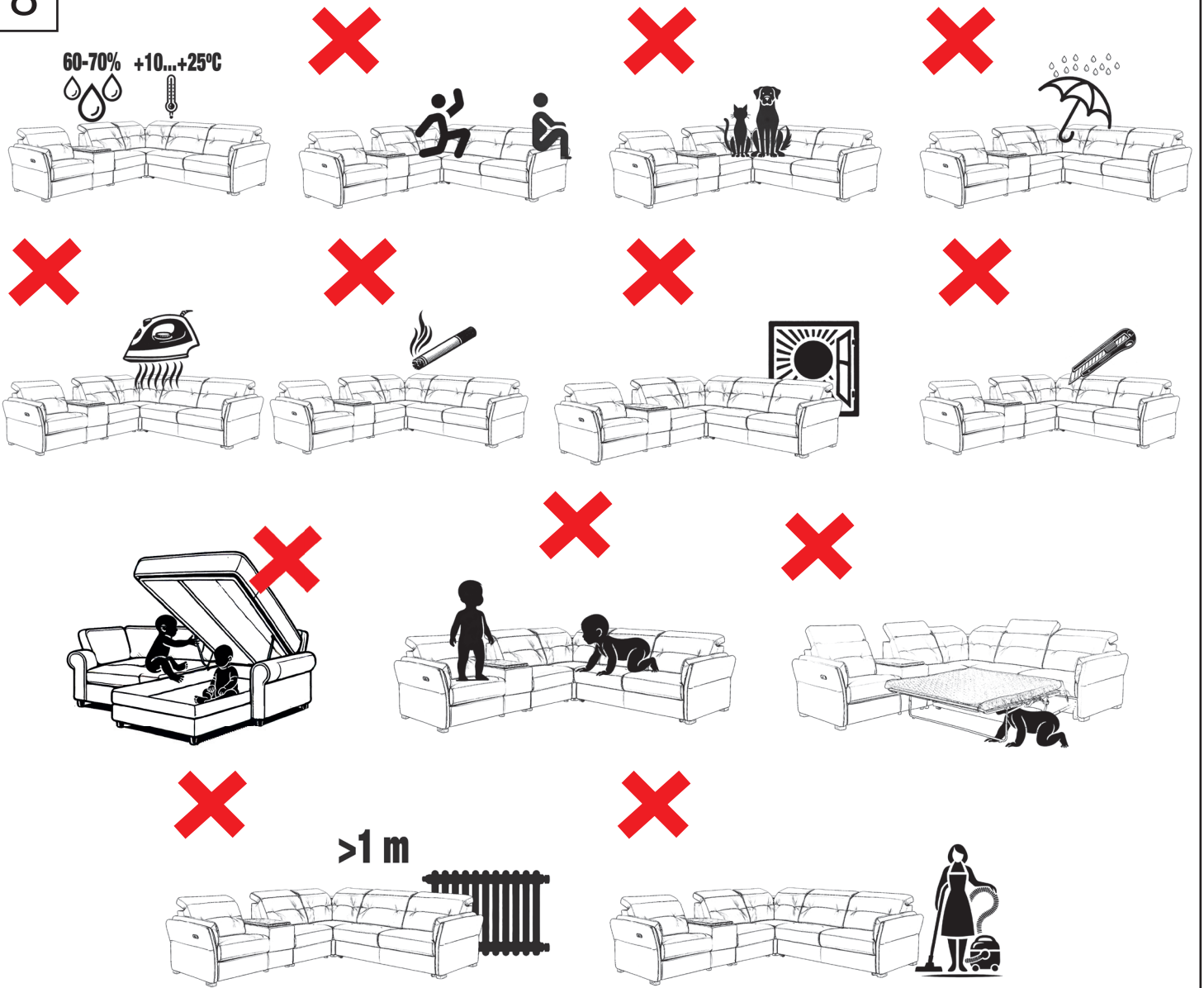

9

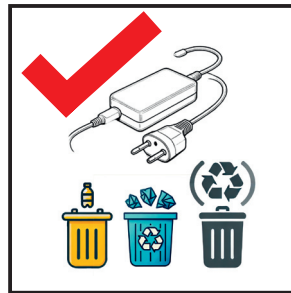

AC/DC ADAPTER
 Model No: KDDY008H
 Input: 100-240V~ 50/60Hz 2.4A
 Output: 28.0V --- 2.0A 58.0W;
 29.0V --- 4.0A Max 118.0W;
 Duty Cycle: Max10%,2min ON/18min OFF
 Caution: risk of electric shock; Dry location use only!
 CHANGZHOU KAI DI ELECTRICAL INC. S/N:2024051801995

AC/DC ADAPTER
 Model No.: ZBHWX-A290020-A
 Input: 100-240V 50/60Hz 1.5A
 Output: DC 29.0V --- 2.0A 58.0W
 Duty Cycle: Max 10%; Max T_ON: 2min
 Date Code: 05.2021
 Efficiency Level: Ⓞ
CAUTION
 Risk of Electric Shock
 Dry location use only
 See instruction manual for use in countries
 Other than the U.S.A.
 This Class B digital apparatus
 complies with Canadian ICES-003
 This device complies with part 15 of
 the FCC rules

Class 2 Power Unit
 UL US LISTED
 60V
 GS
 CE
 See the instruction manual for
 proper selection of the power
 supply cord
 Made In China

eMoMo Power Supply
 MODEL: R122-0502000ED
 INPUT: 100-240V~
 50/60Hz 0.6A
 OUTPUT: 5.0V --- 2.0A 10.0W
 MADE IN CHINA



BRONX 3/3