

5/6

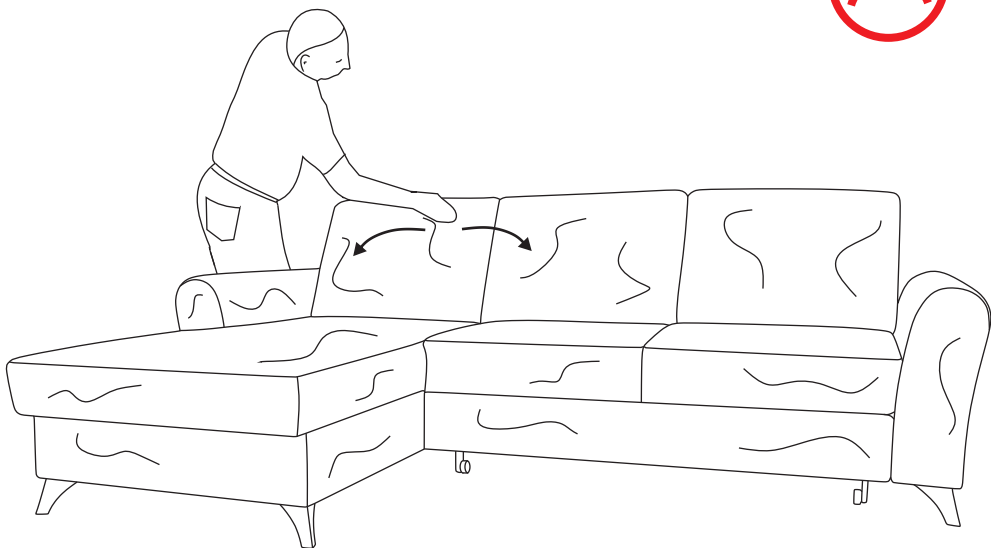

6/6

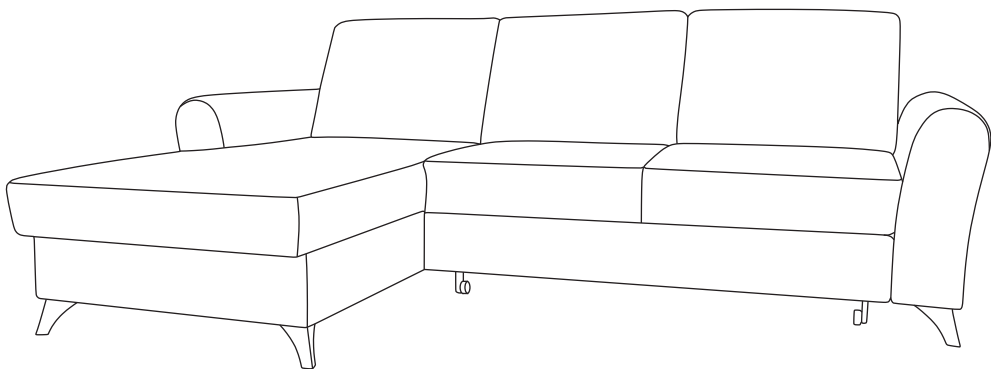

4

Modell: Tucson

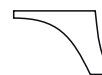
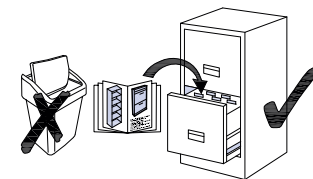
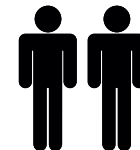
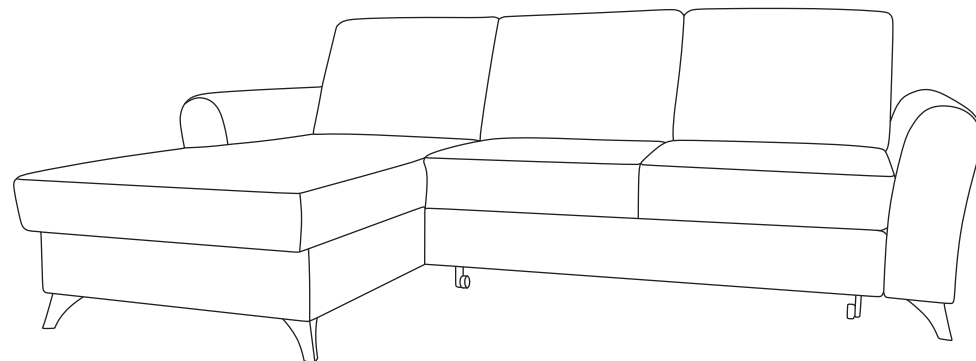

(K) x 6szt
NR.160 CHEOM



(M) x 2szt
50x110 METAL
CHROM



(S) x 12szt
M.8x25 ŚRUBA



x 1szt
Ø5

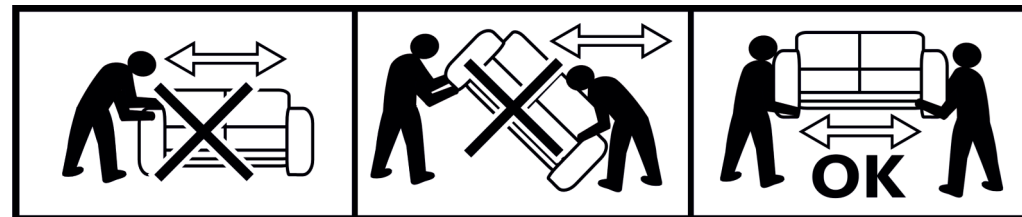

1

1/6

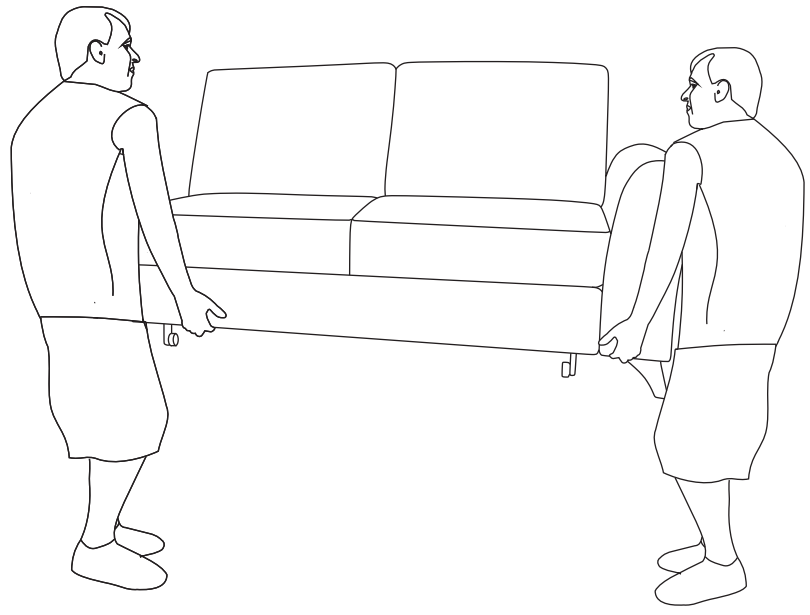

3/6

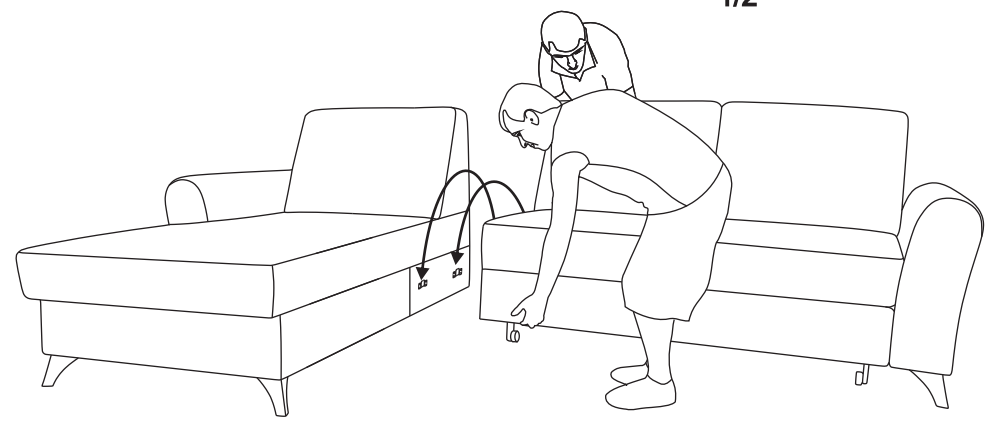
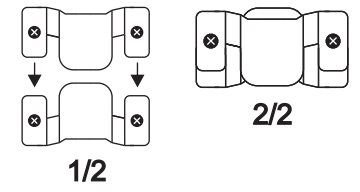

2/6

- nr.160 chrom = (K) x 6szt
- ∅50x110 metal - chrom = (M) x 2szt
- M.8 x 25 śruba = (S) x 12szt
- ∅5 = x 1szt

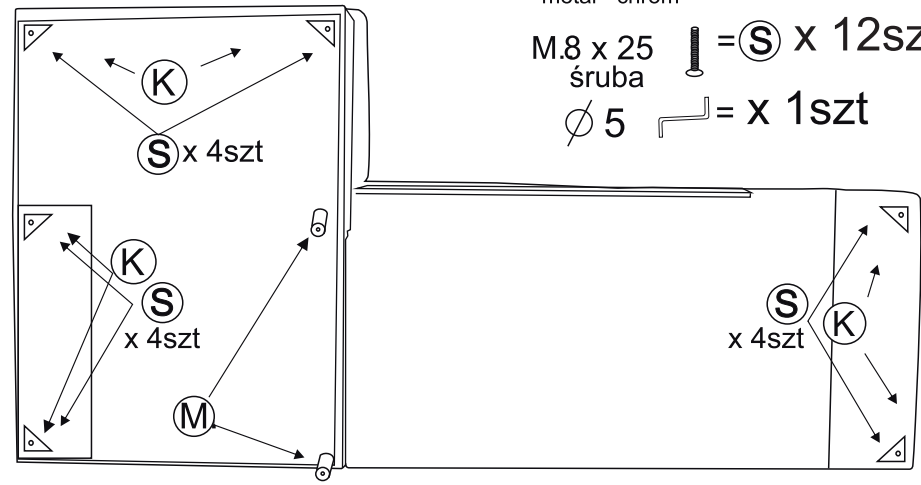

2

4/6

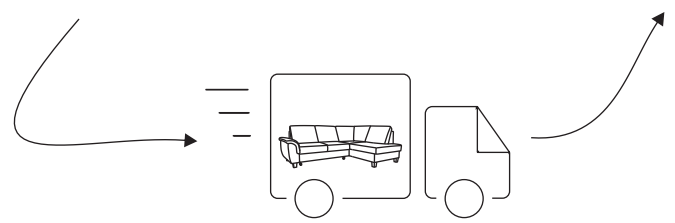
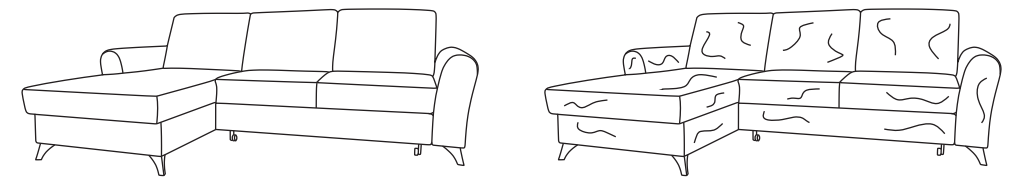

3