

# Instrukcja montażu mebli «MORTIZ»

Lustro wiszące 80

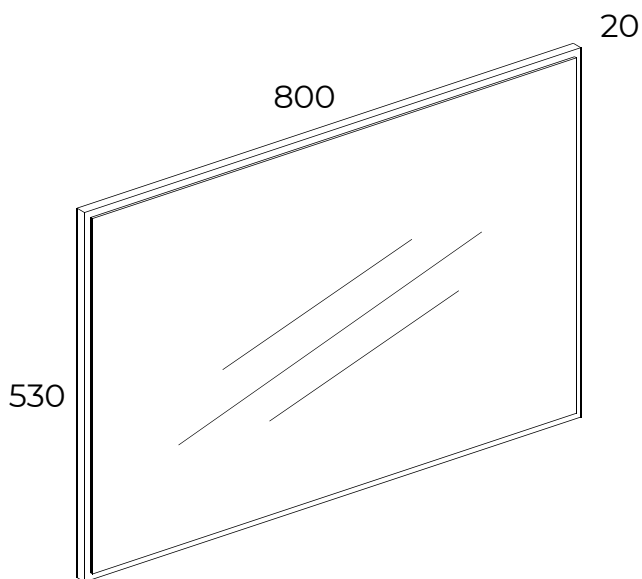

---

Production date  
Data produkcji



---

Stamp of Quality Department  
Pieczęć Działu Jakości

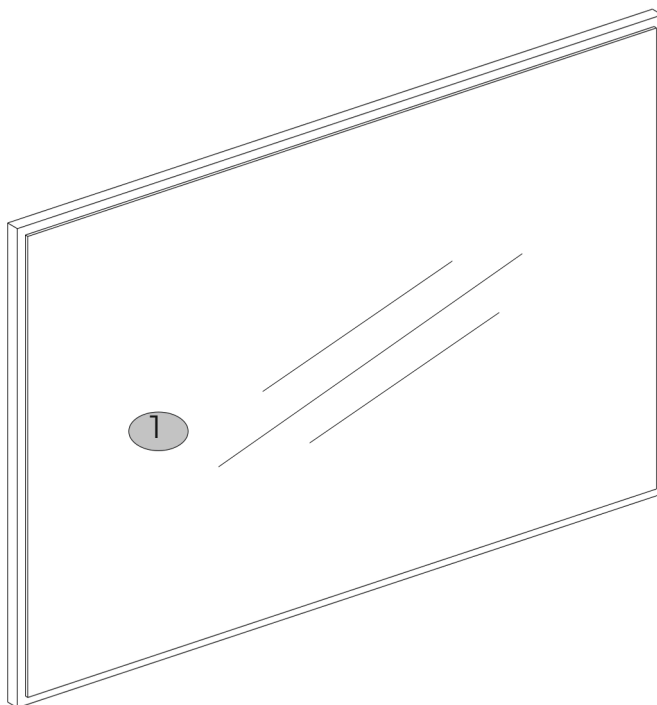
<b>№</b>	<b>L, mm</b>	<b>B, mm</b>	<b>H, mm</b>	<b>Q</b>	<b>№ pack</b>
1	800	530	20	1	1/1





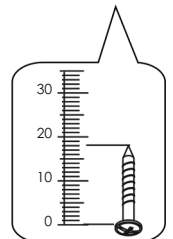
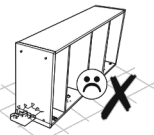
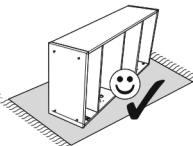
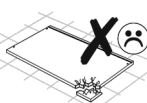
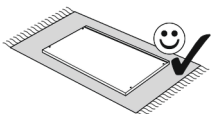
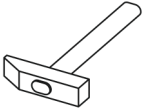
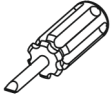
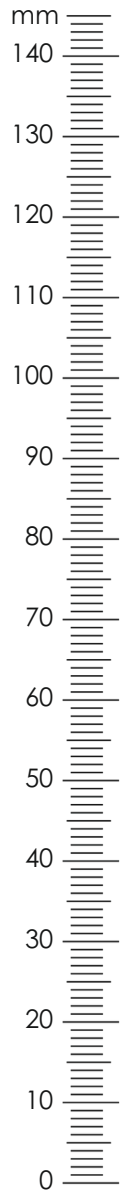

B3	B5	R27
		
Ø35	2 10x50	2 5,0x13
	2	4



1

<b>B3</b>  Ø35	<b>R27</b>  5,0x13
2	4

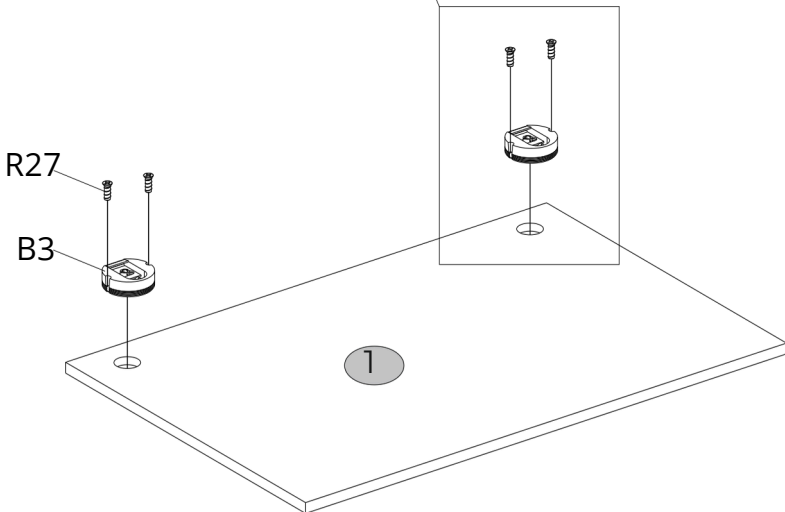
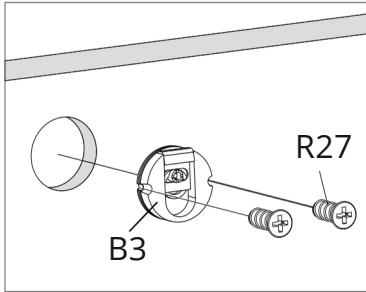

2

