

Miami

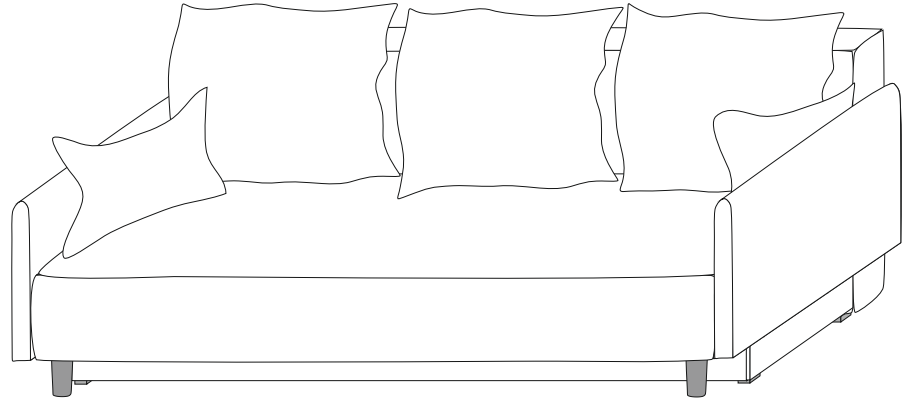

G 6x25

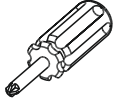
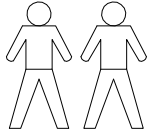
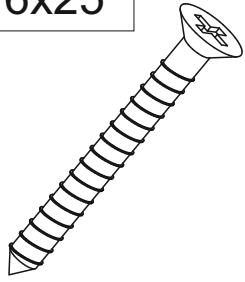

x6

B1

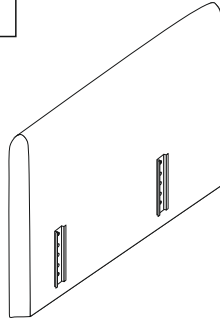

x1

B2

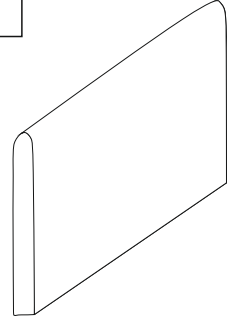

x1

PD

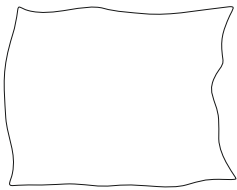

x3

PM

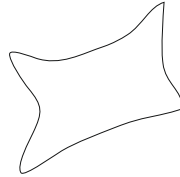

x2

S

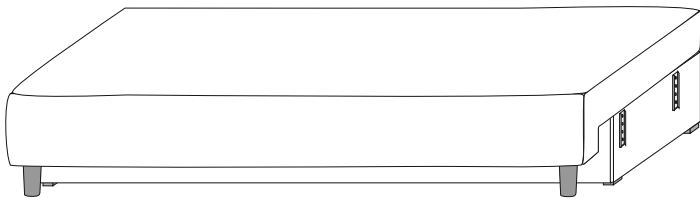

x1

O

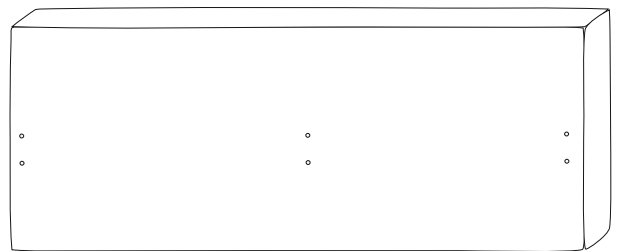

x1

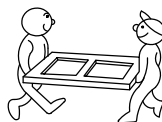

I

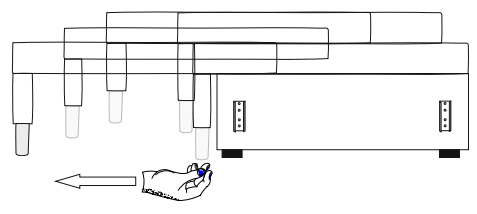
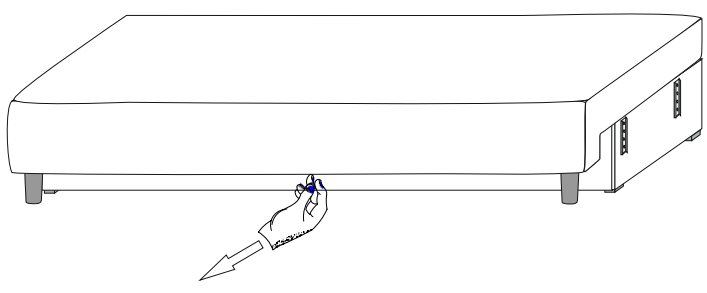

II

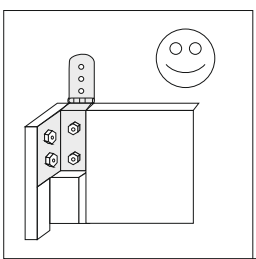
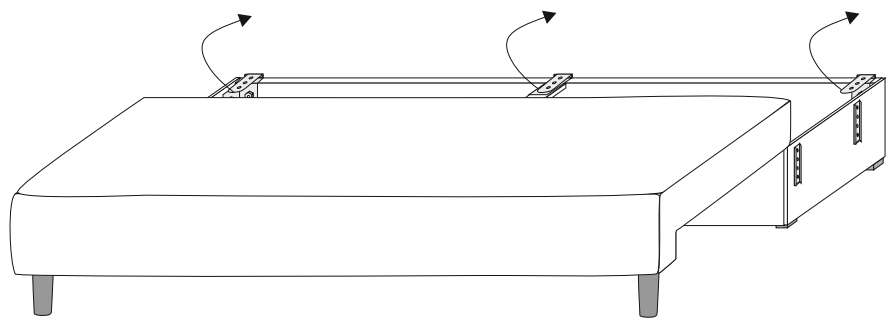

III

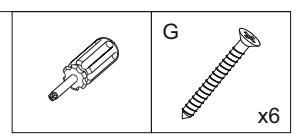
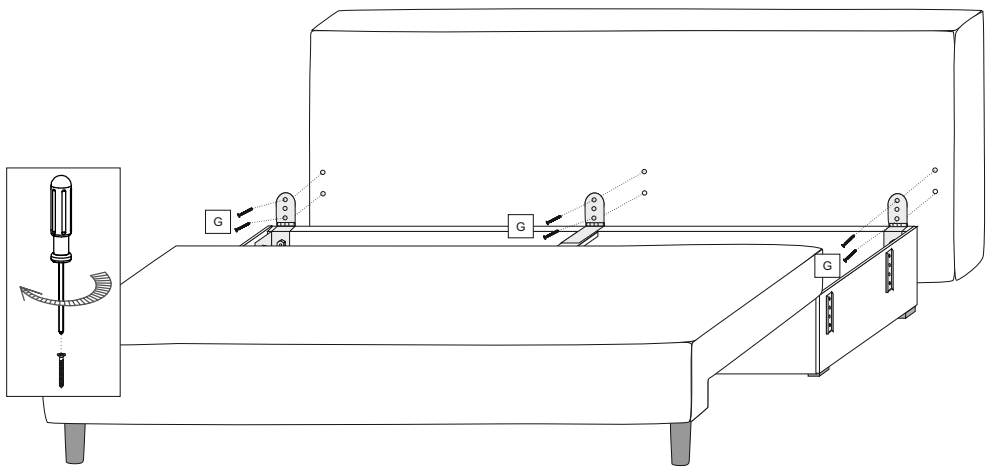

IV

