

# SELEDO

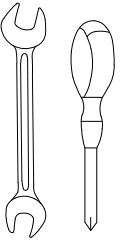

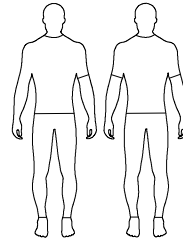

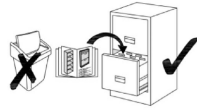

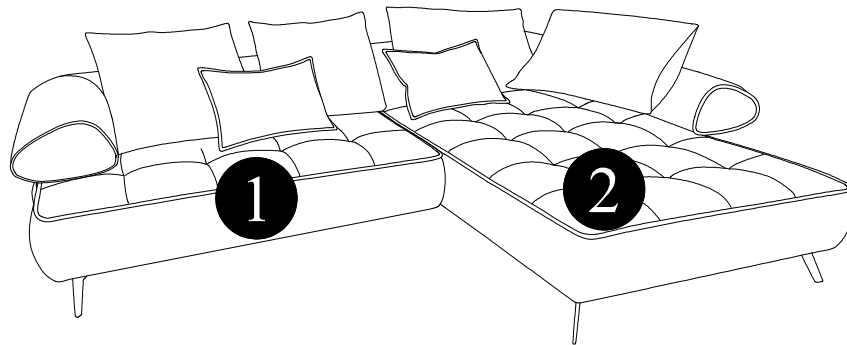

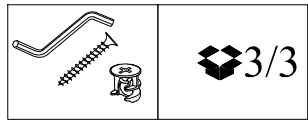
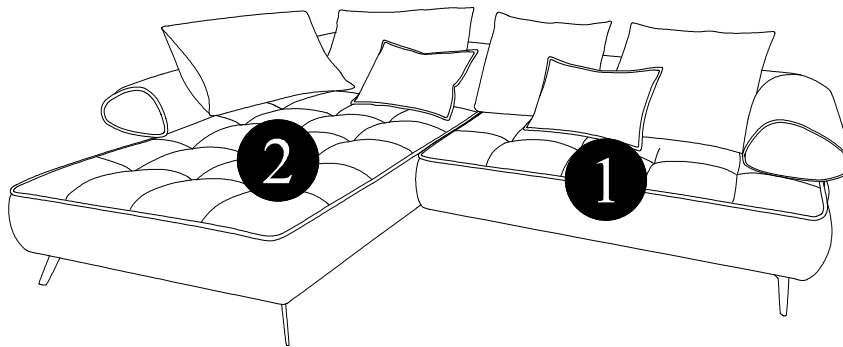

Teil	L	W	H	Pcs	Colli
1	163	123	55	1x	1/3
2	219	111	55	1x	2/3

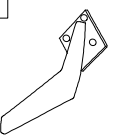
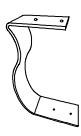
## R



## L

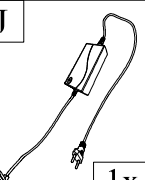
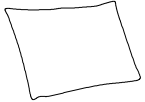
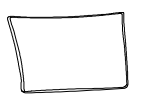

A	B	C	D	E	F	G	H	I
								
5x	6x	2x	12x	10x	1x	1x	12x	15x
H-170		H-170	M6	M6 X 60	M6 X 70	M6 X 45	M6 X 25	5X30
J	K	L						
								
1x	58x46 4x	52x32 2x						



B	H
6x	12x
M6 X 25	





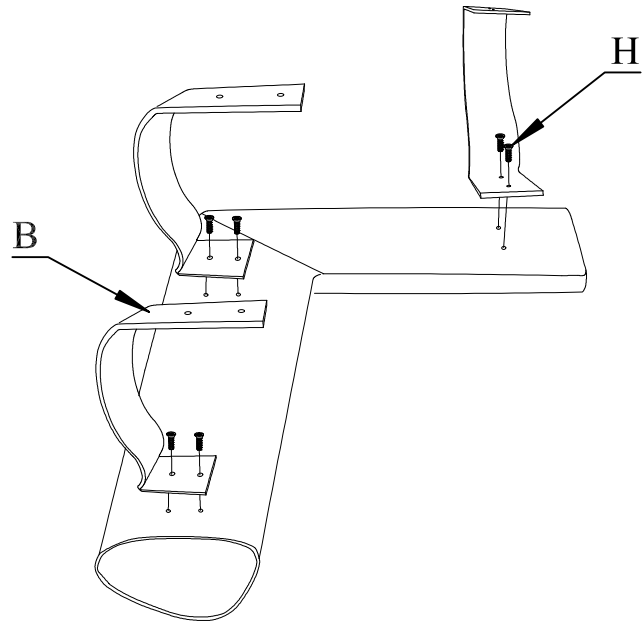
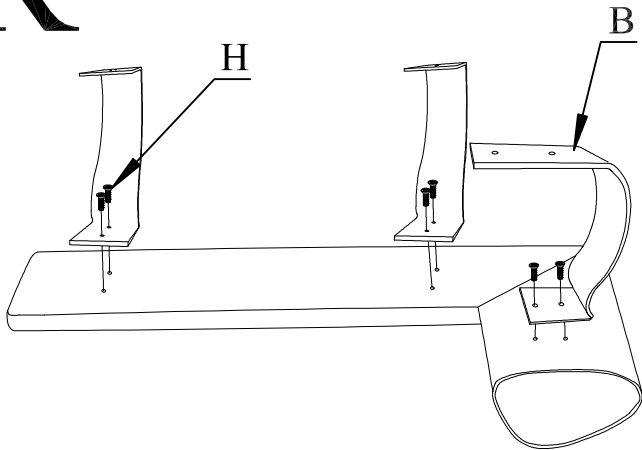

1

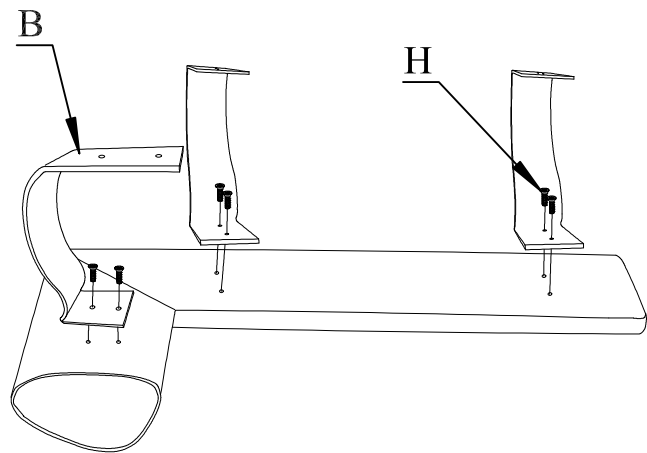
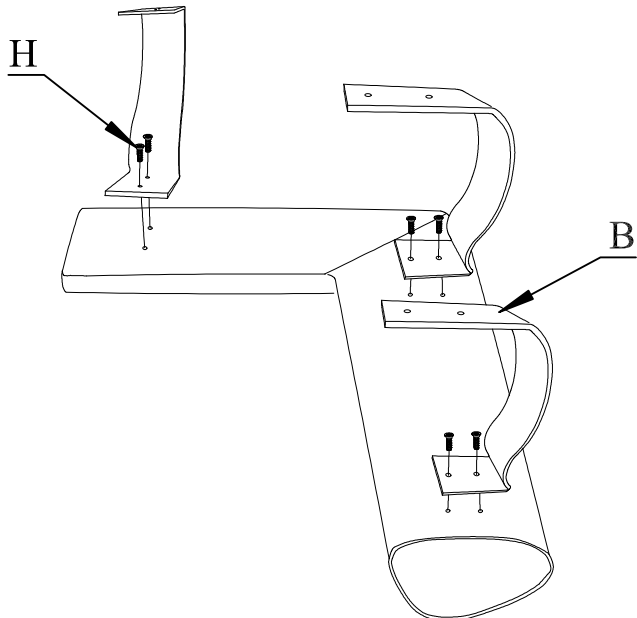
R

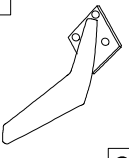

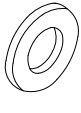
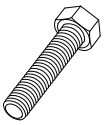

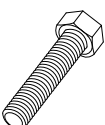
L

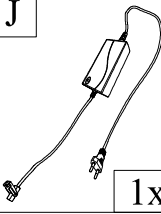

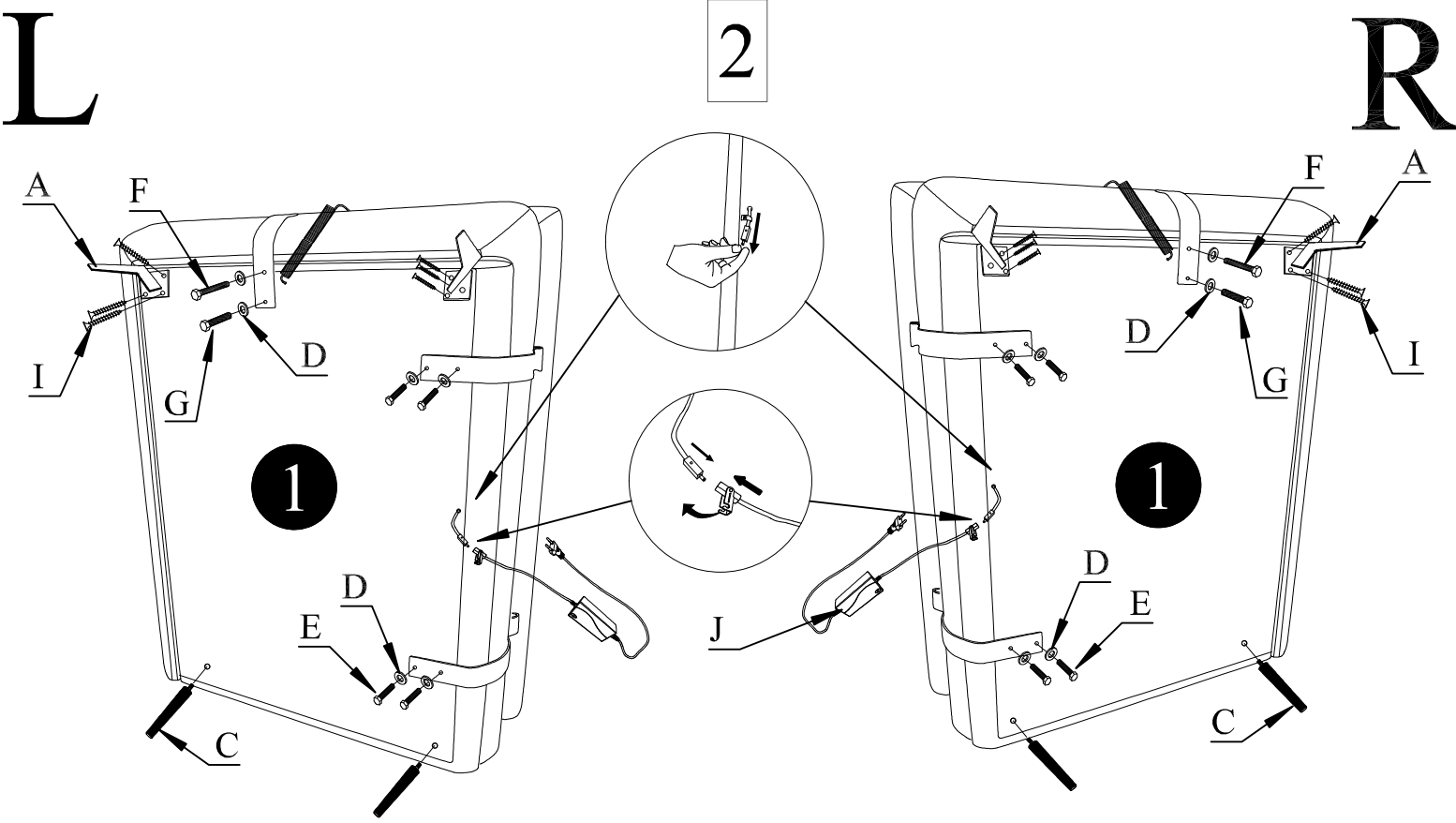
<b>A</b> 	<b>C</b> 	<b>D</b> 	<b>E</b> 	<b>F</b> 	<b>G</b> 	<b>I</b> 	<b>J</b> 
2x	2x	6x	4x	1x	1x	6x	1x
H-170	H-170	M6	M6 X 60	M6 X 70	M6 X 45	5x30	

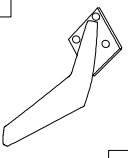
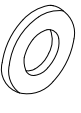
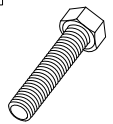

<b>A</b> 	<b>D</b> 	<b>E</b> 	<b>I</b> 
3x	6x	6x	9x
H-170	M6	M6 X 60	5x30

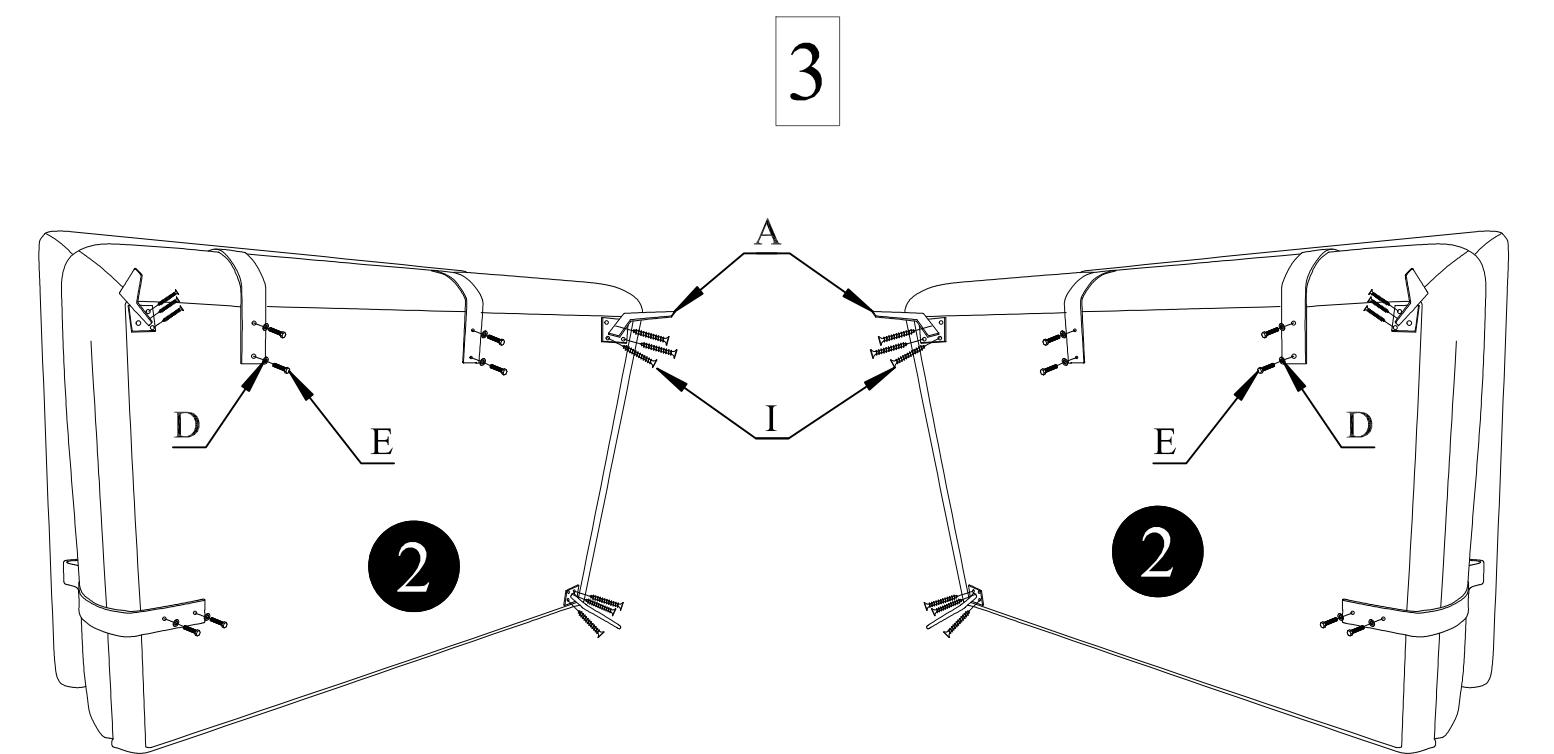

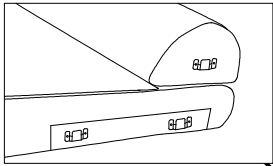
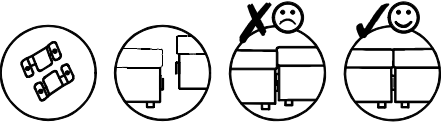

4

