

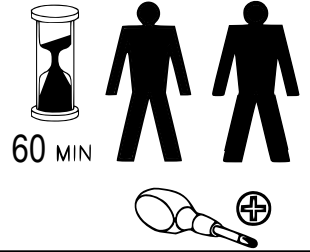

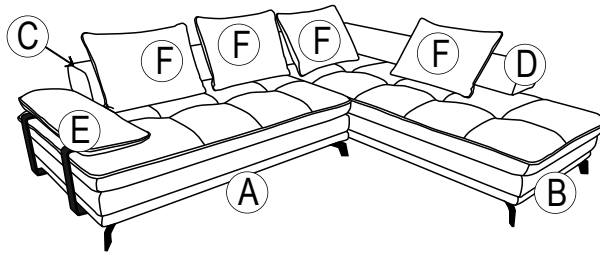

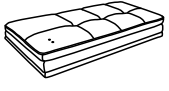

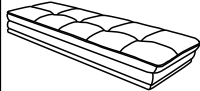



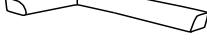

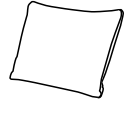



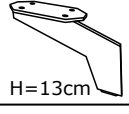
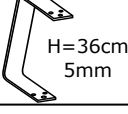
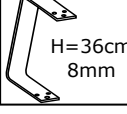

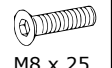
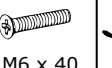

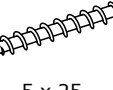
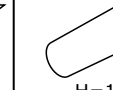

FLORENCE RELAX

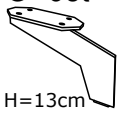
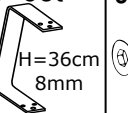
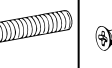
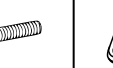
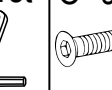
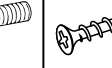
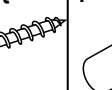

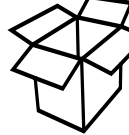

A- 1st 	B- 1st 	C- 1st 	D- 1st 	E- 1st 	F- 4st 
 1/5	 2/5	 3/5			

G- 3st  H=13cm	H- 2st  H=36cm 5mm	I- 2st  H=36cm 8mm	J- 12st  M8 x 40	K- 6st  M8 x 25	L- 6st  M6 x 40	M- 1st  AC/DC	N- 1st  5mm	O- 6st  M8 x 60	U- 6st  5 x 25	P- 1st  H=13cm
 4/5 										

G- 3st  H=13cm	I- 3st  H=36cm 8mm	J- 9st  M8 x 40	L- 6st  M6 x 40	N- 1st  5mm	O- 9st  M8 x 60	U- 6st  5 x 25	P- 1st  H=13cm	① 	 3/5	 4/5
 5/5										

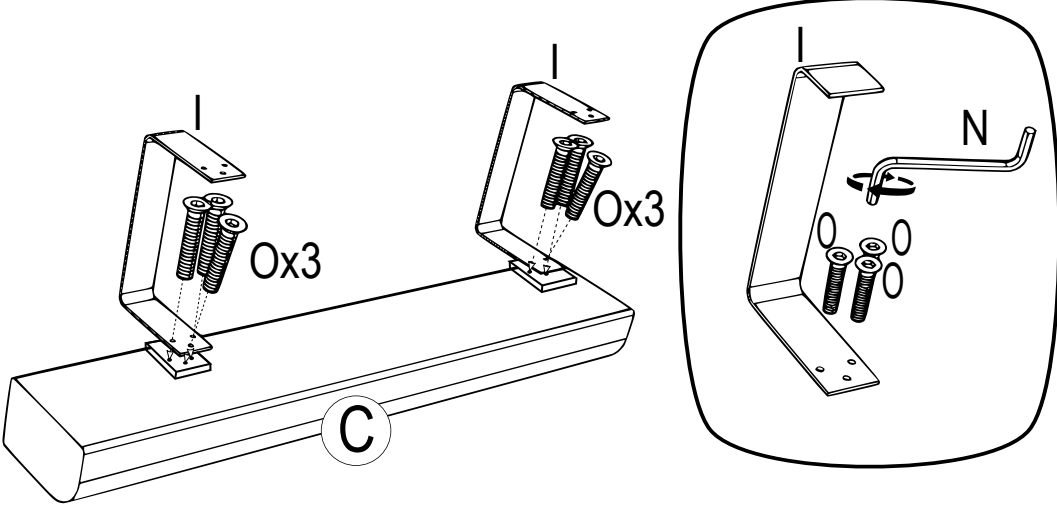

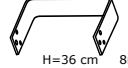
②

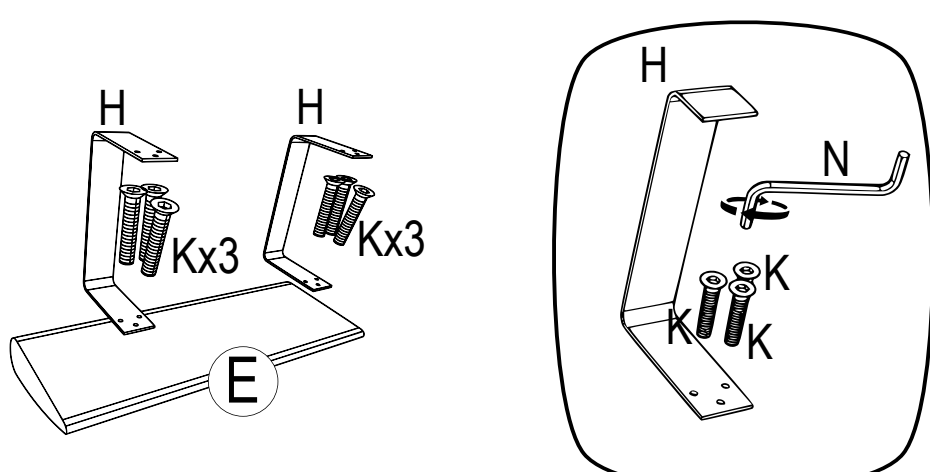

I		x2
O		x6
N		x1

③

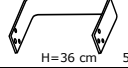

H		x2
K		x6
N		x1

FLORENCE RELAX

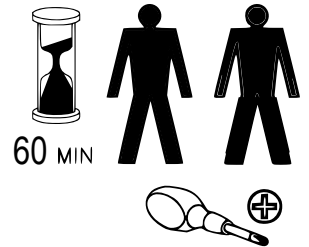
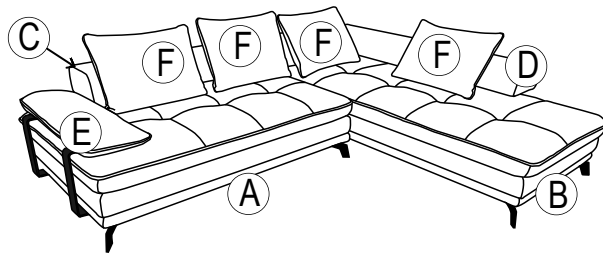

4

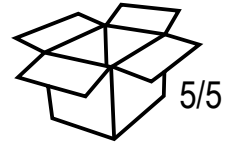
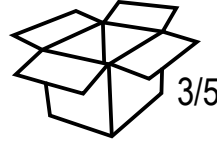
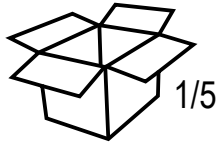

5

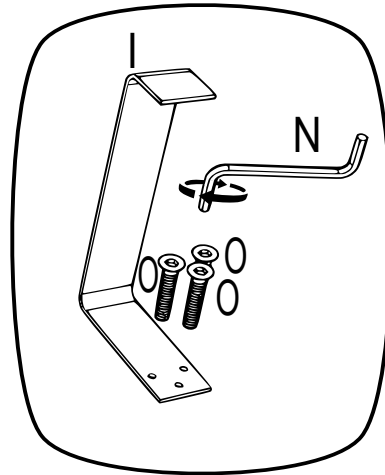
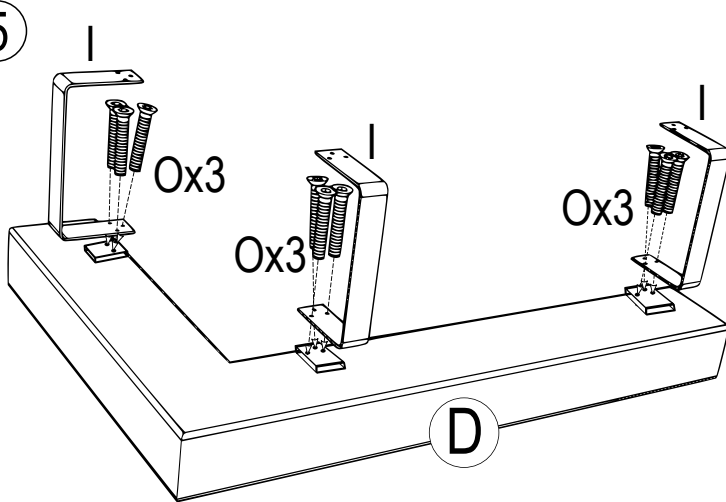

I		x3
O		x9
N		x1

H=36 cm
M8 x 60
5 mm

6

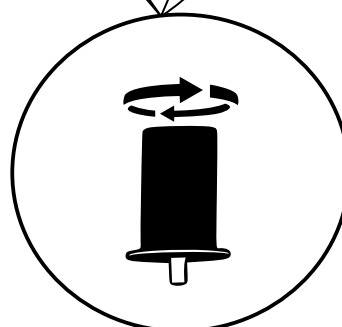
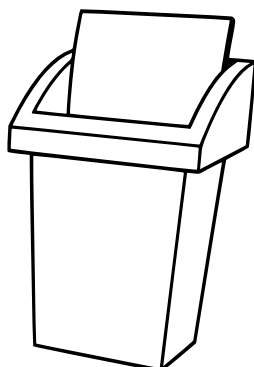
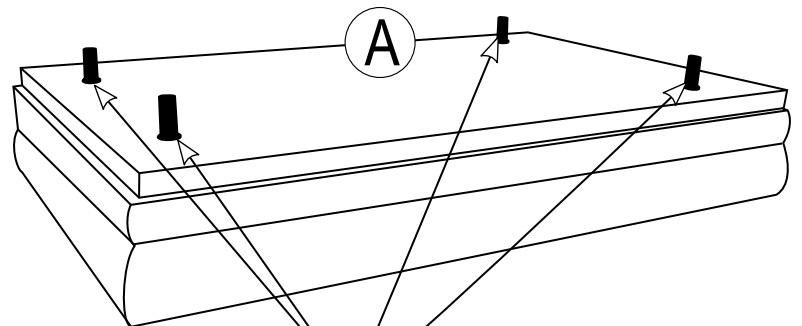
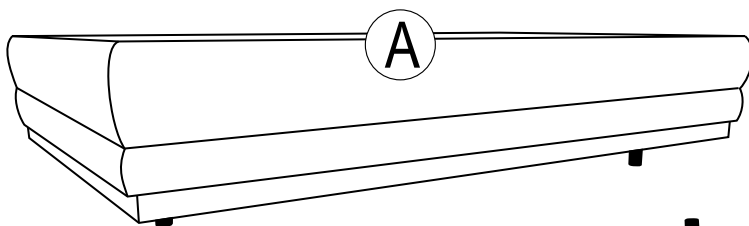

FLORENCE RELAX

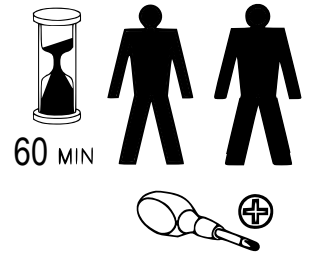
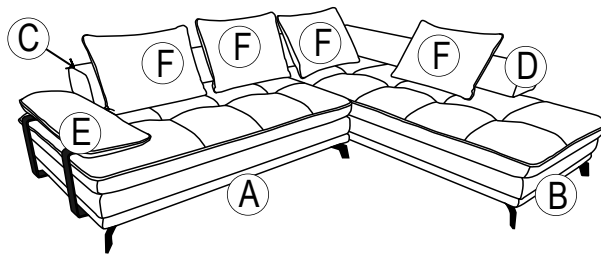

7

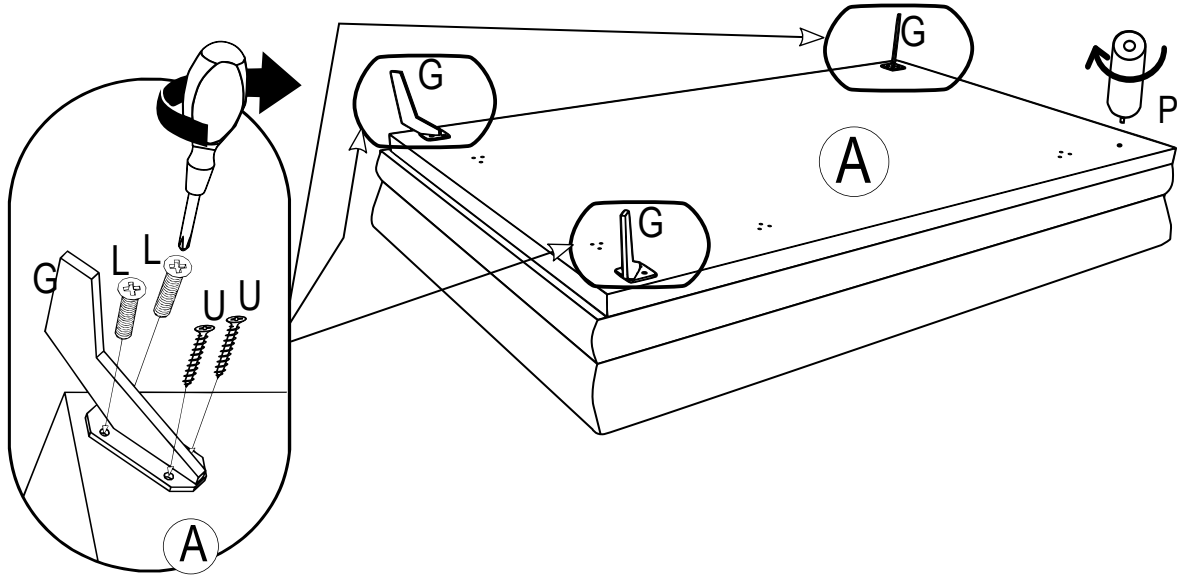
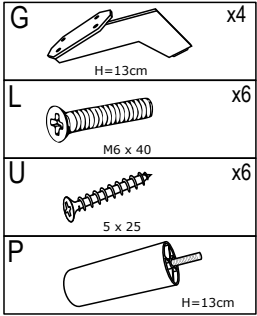
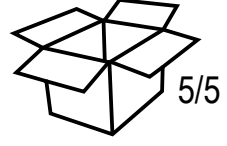
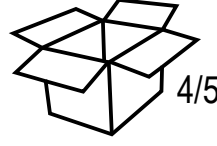
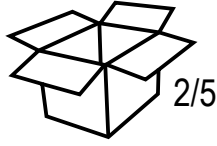
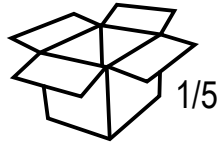

9

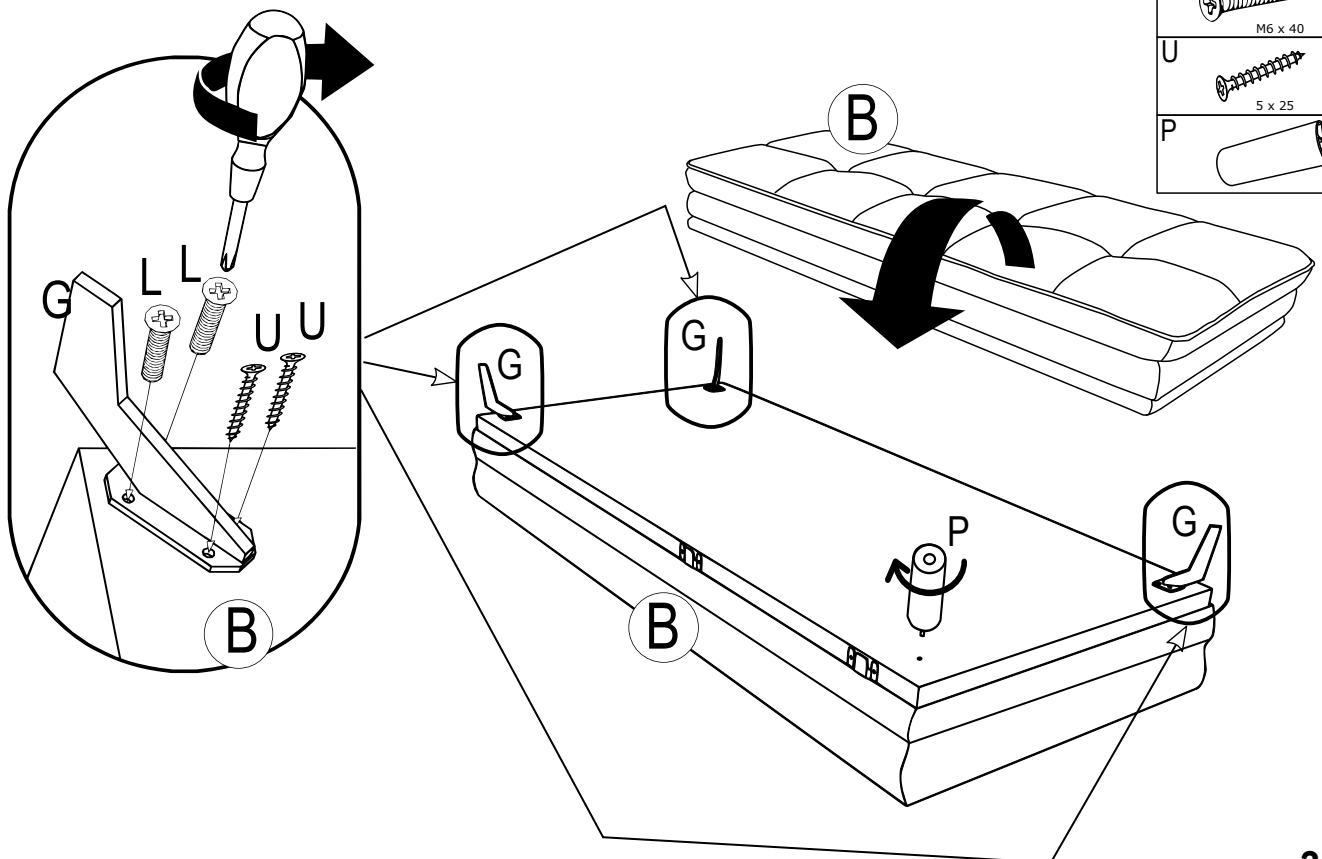
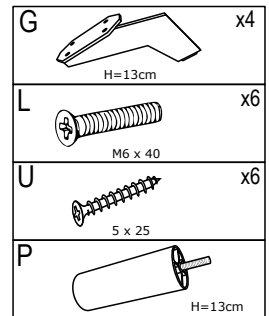

FLORENCE RELAX

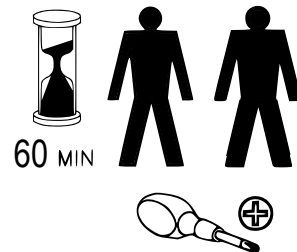
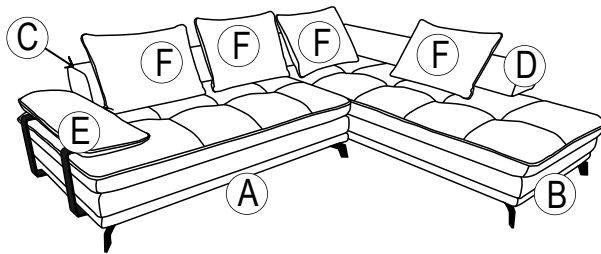

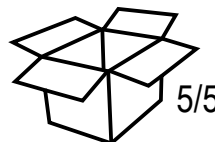
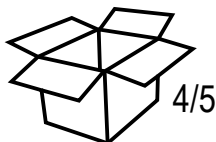

10

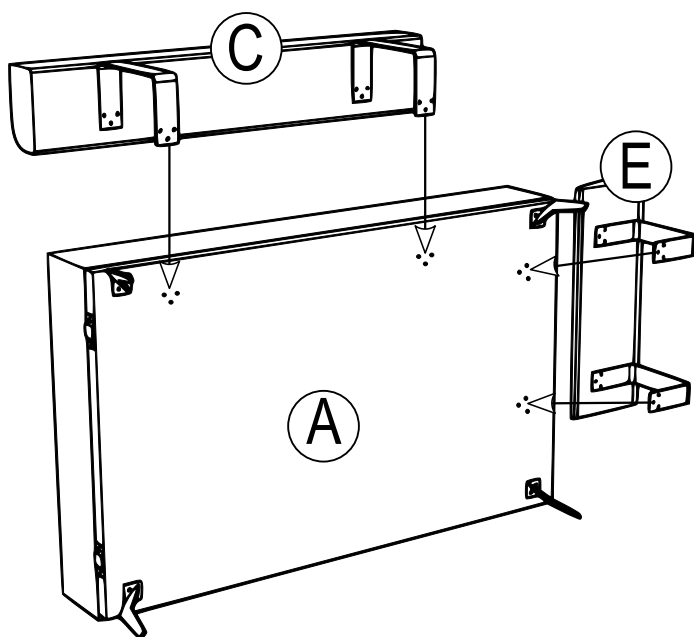

11

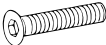

J		x21
	M8 x 40	
N		x1
	5 mm	

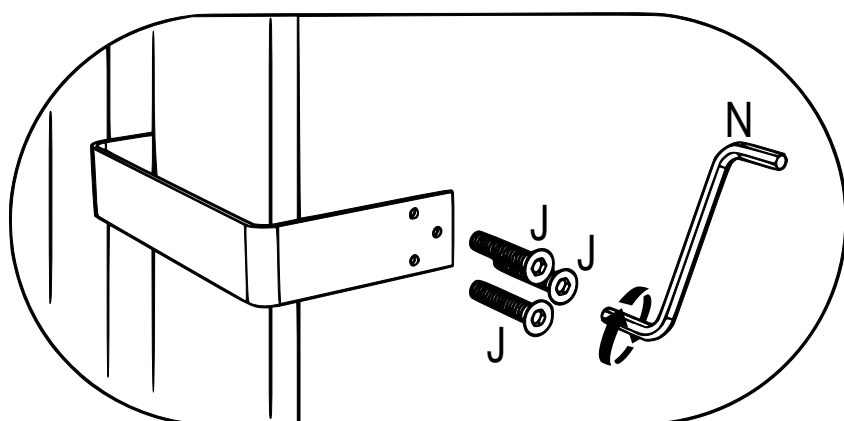
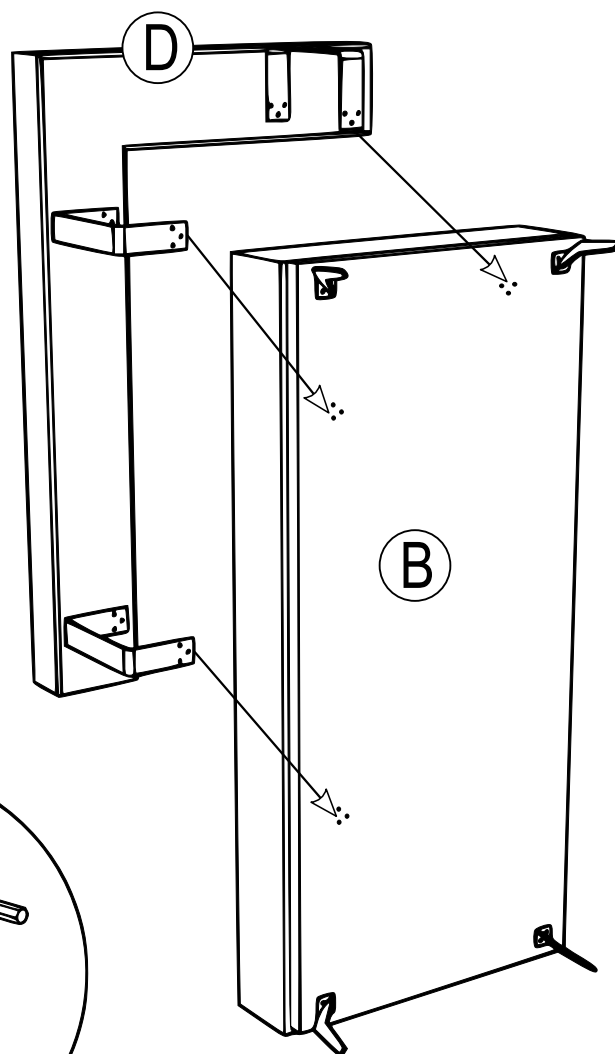

FLORENCE RELAX

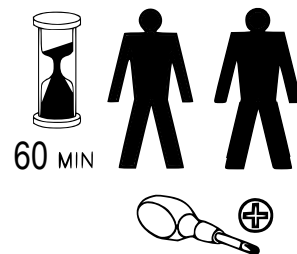
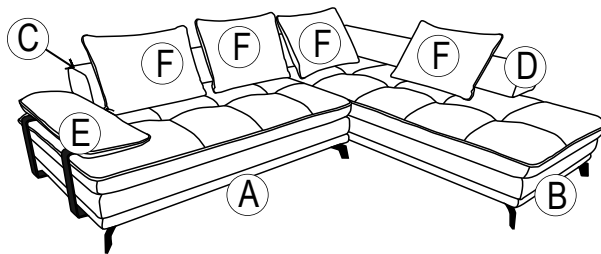

12

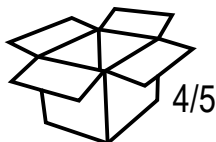

13

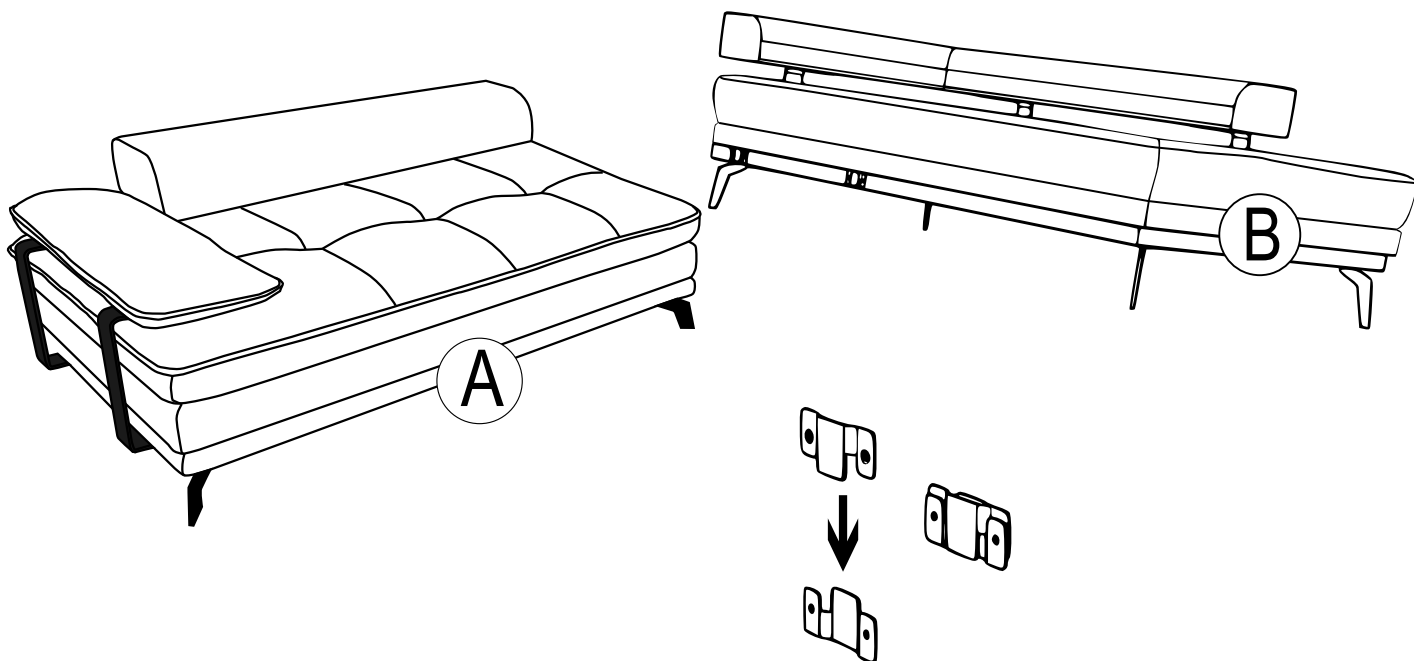

14

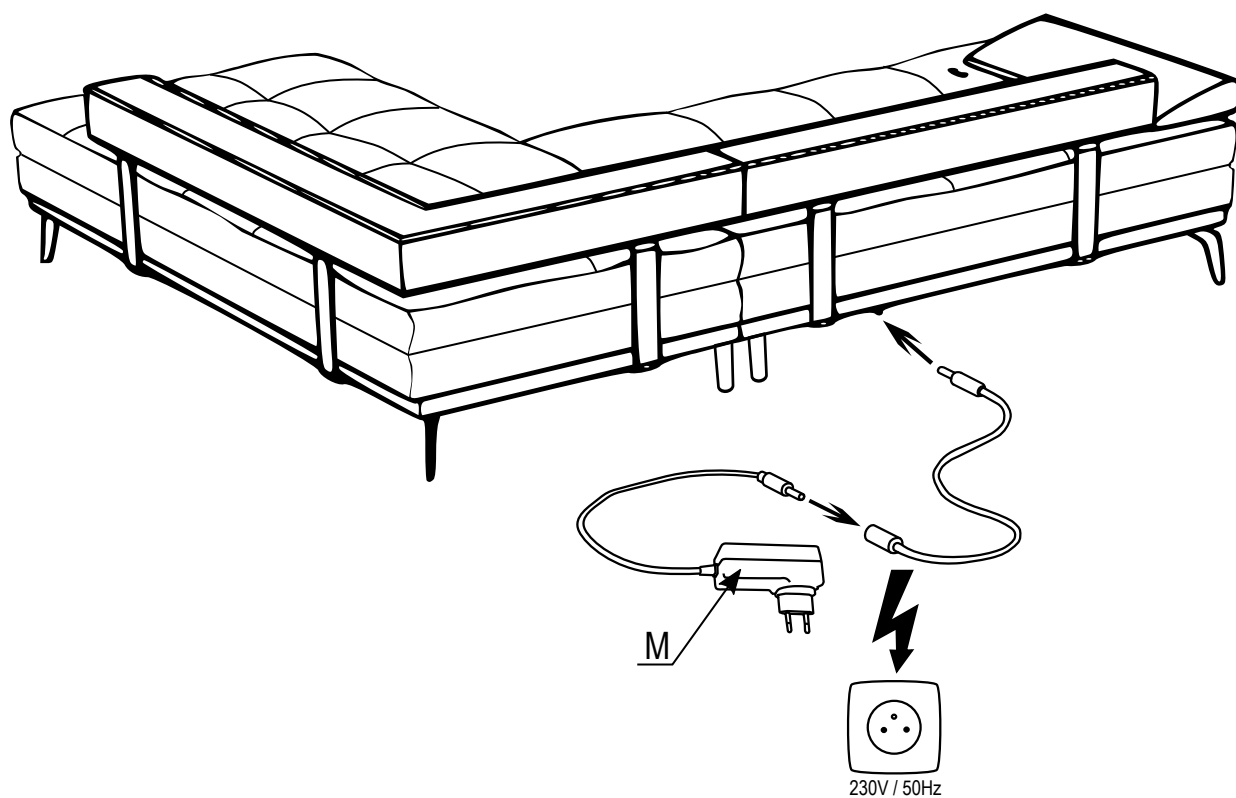

FLORENCE RELAX

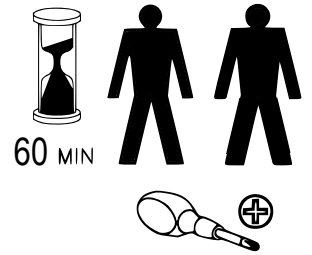
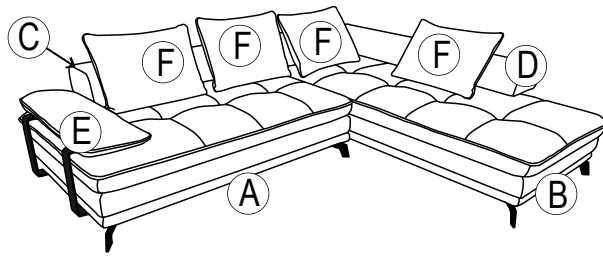

15

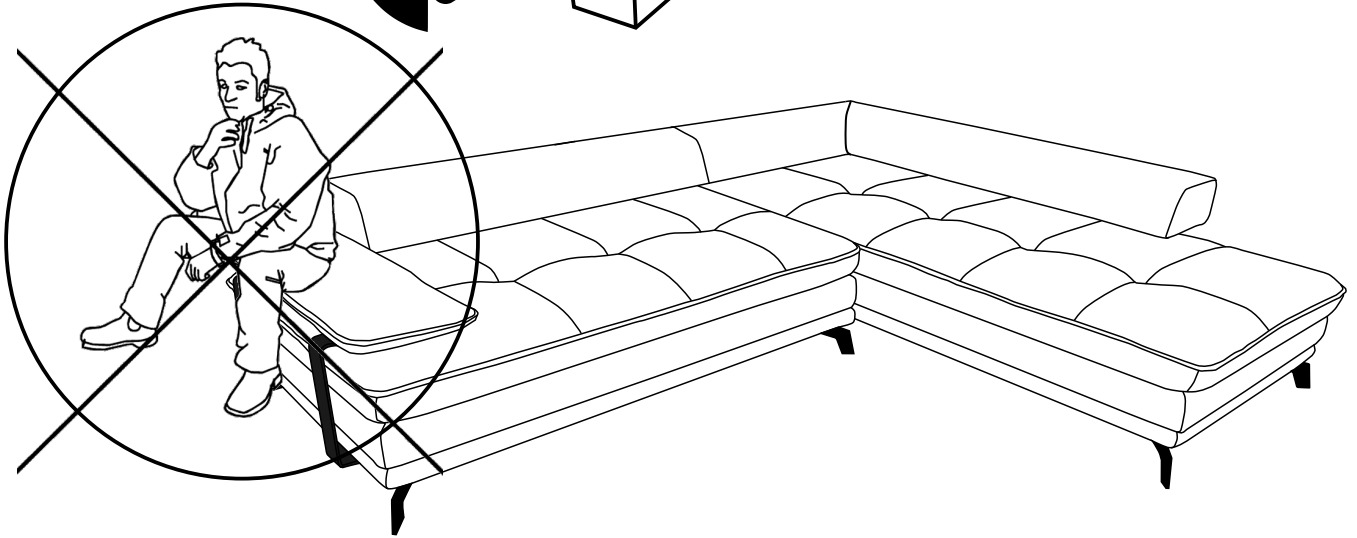
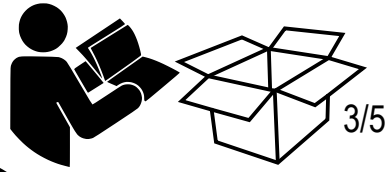



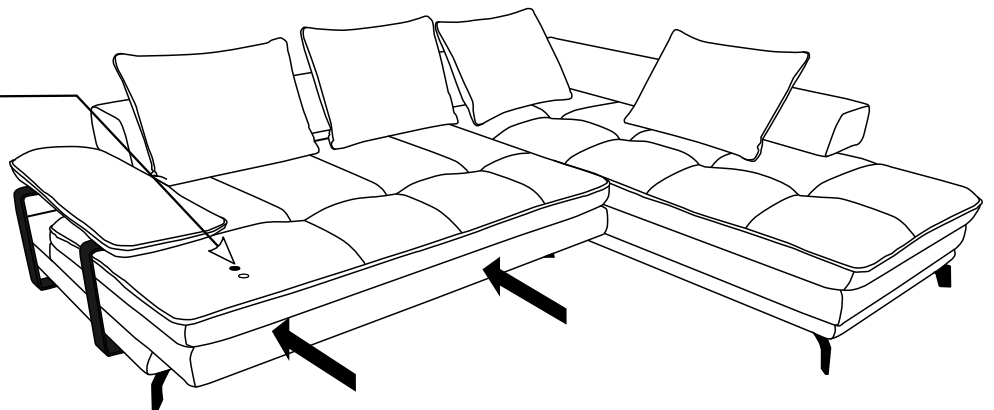
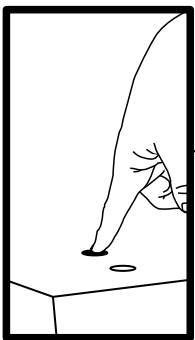
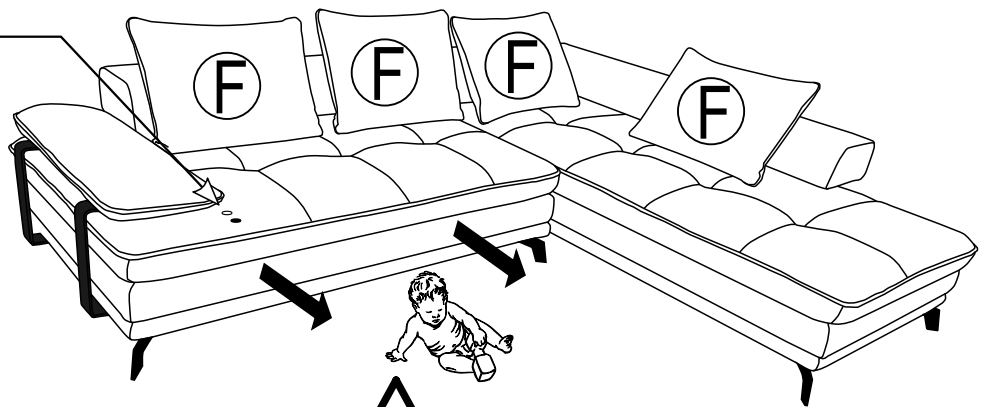
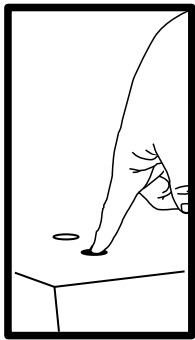



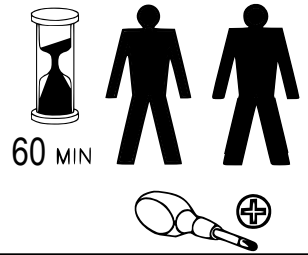
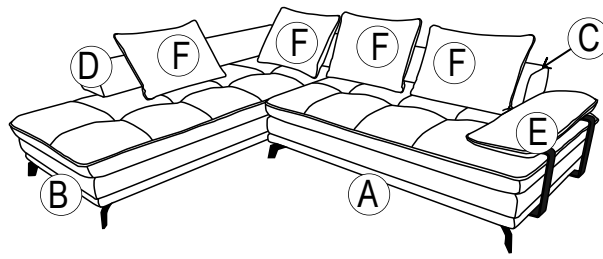

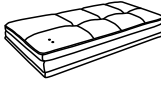
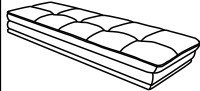

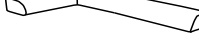

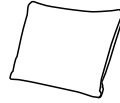



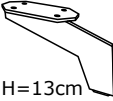

16

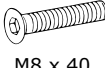
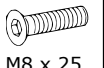
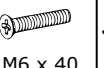



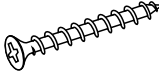





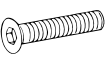

FLORENCE RELAX

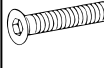

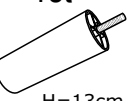

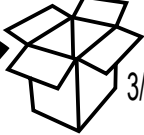
A- 1st 	B- 1st 	C- 1st 	D- 1st 	E- 1st 	F- 4st 
 1/5	 2/5	 3/5			

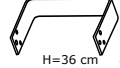

G- 3st  H=13cm	H- 2st  H=36cm 5mm	I- 2st  H=36cm 8mm	J- 12st  M8 x 40	K- 6st  M8 x 25	L- 6st  M6 x 40	M- 1st  AC/DC	N- 1st  5mm	O- 6st  M8 x 60	U- 6st  5 x 25	P- 1st  H=13cm
 4/5										

G- 3st  H=13cm	I- 3st  H=36cm 8mm	J- 9st  M8 x 40	L- 6st  M6 x 40	N- 1st  5mm	O- 9st  M8 x 60	U- 6st  5 x 25	P- 1st  H=13cm	① 	 3/5	 4/5
 5/5										

②

I		x2
	H=36 cm 8mm	
O		x6
	M8 x 60	
N		x1
	5 mm	

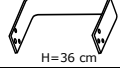
③

H		x2
	H=36 cm 5mm	
K		x6
	M8 x 25	
N		x1
	5 mm	

FLORENCE RELAX

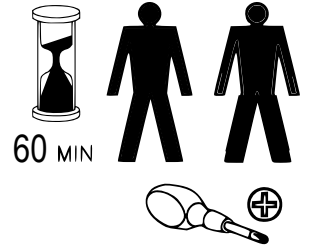
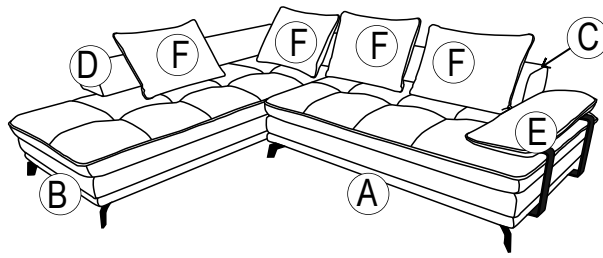

4

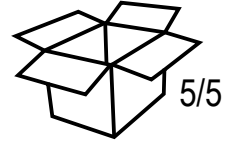
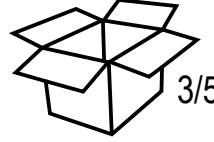
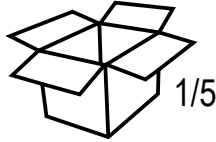

5

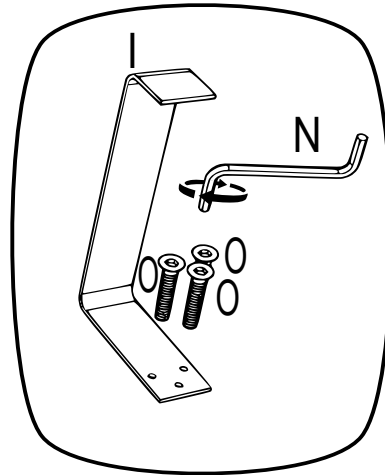
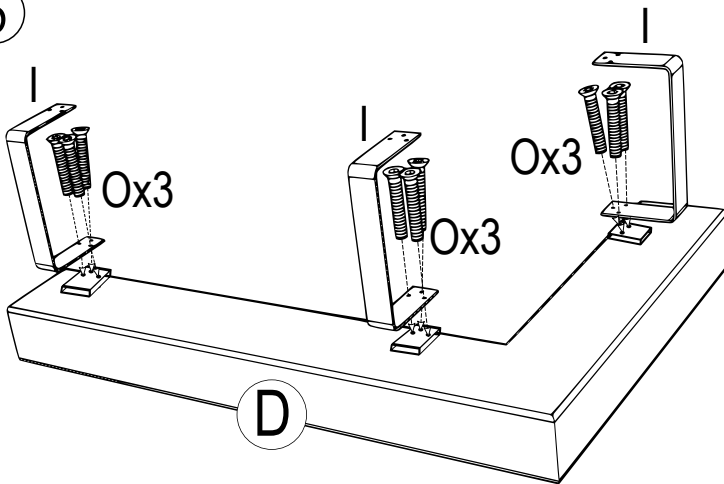

I		x3
	H=36 cm	
O		x9
	M8 x 60	
N		x1
	5 mm	

6

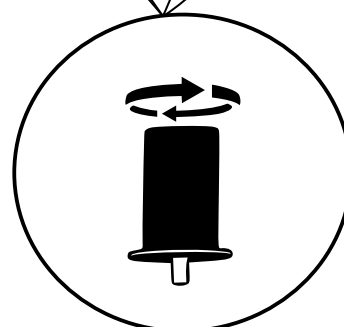
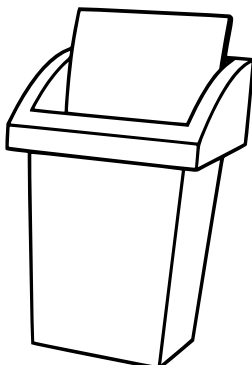
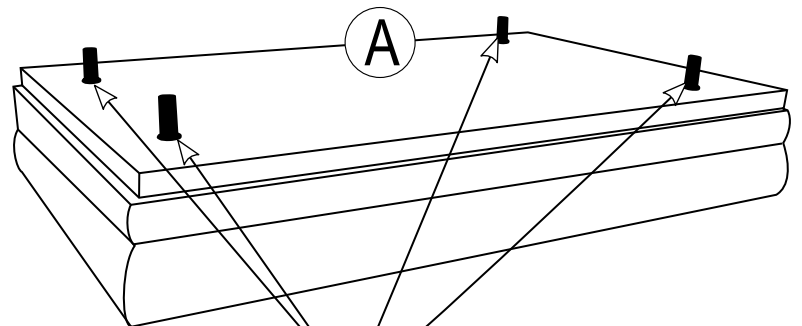
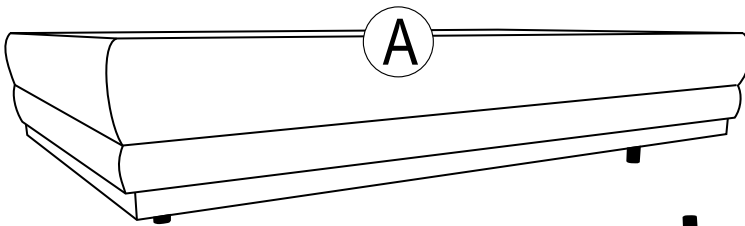

FLORENCE RELAX

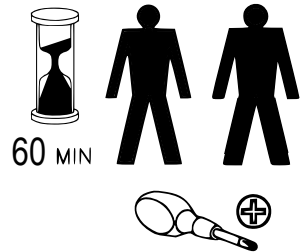
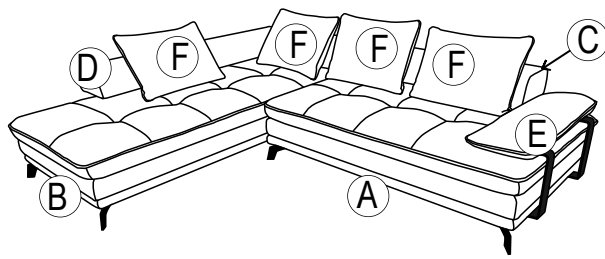

7

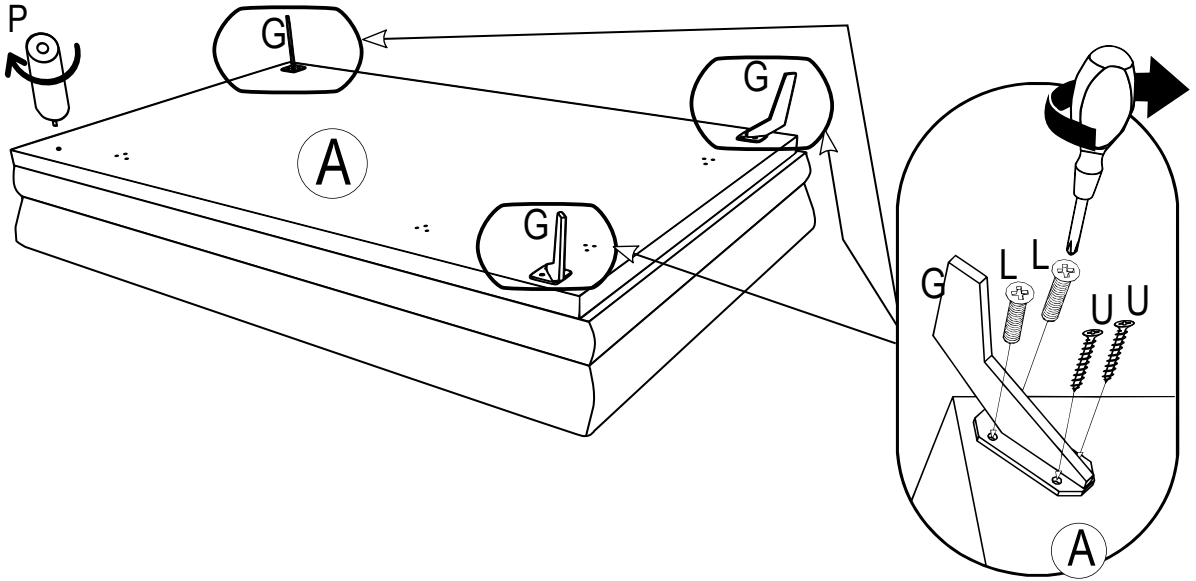
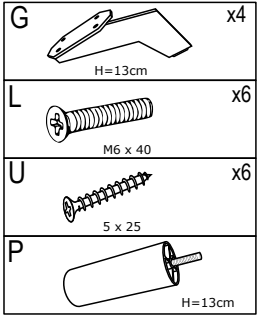
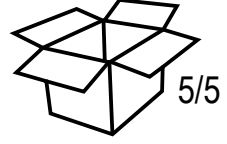
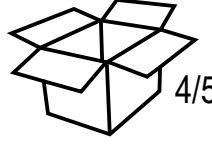
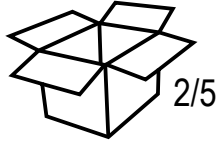
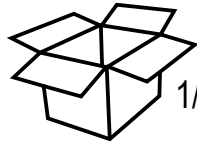

9

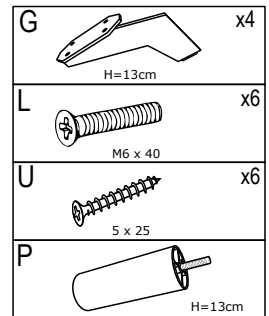
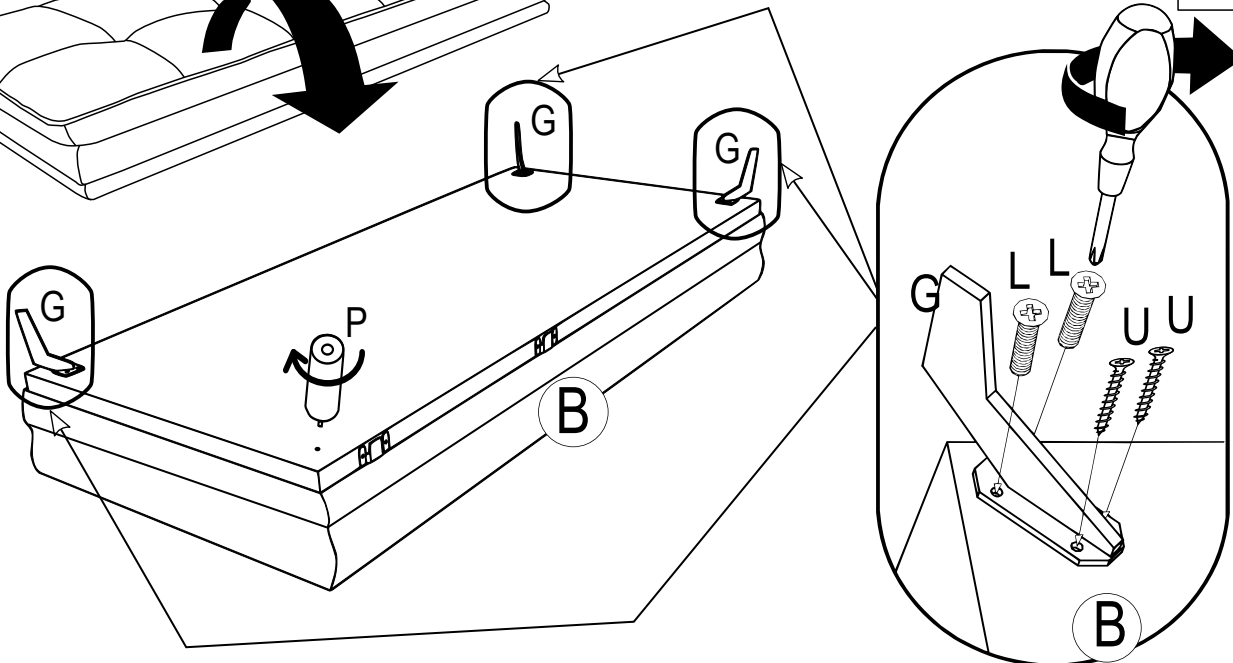
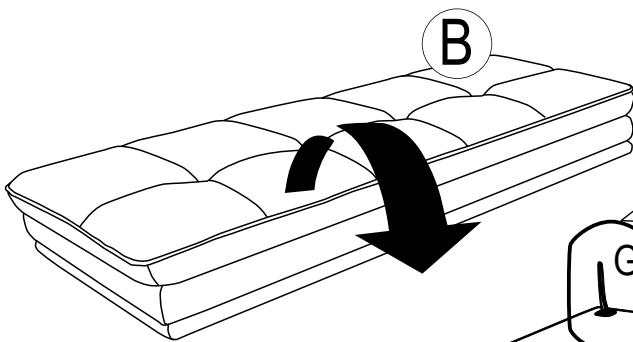

FLORENCE RELAX

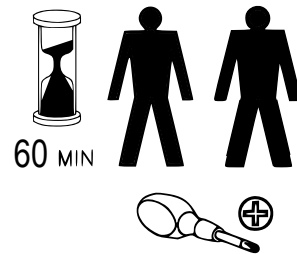
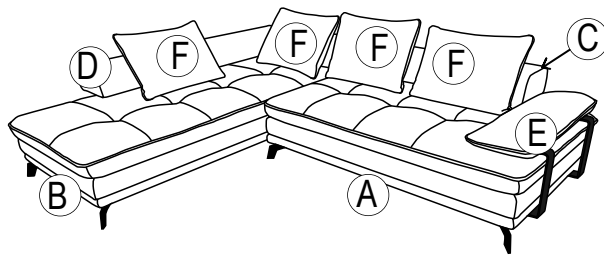

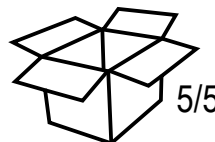
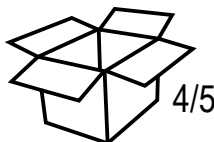

10

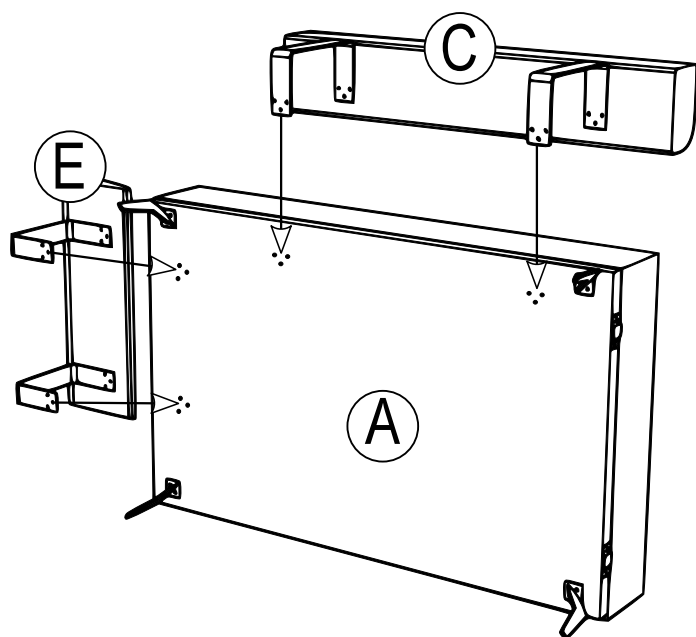

11

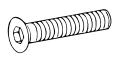

J		x21
	M8 x 40	
N		x1
	5 mm	

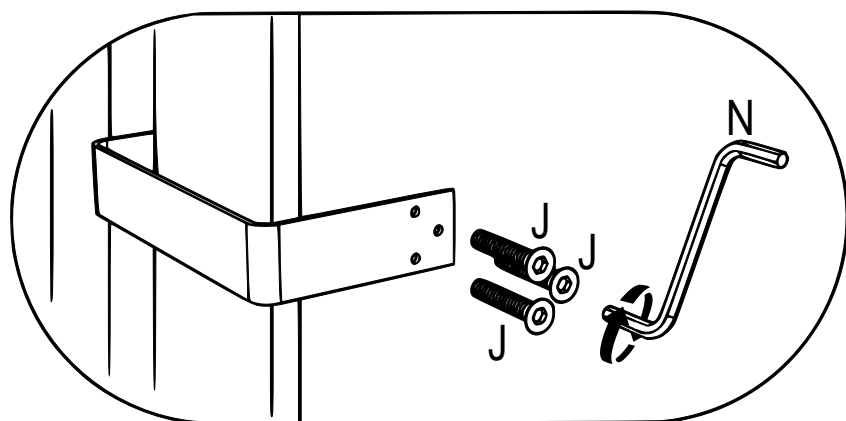
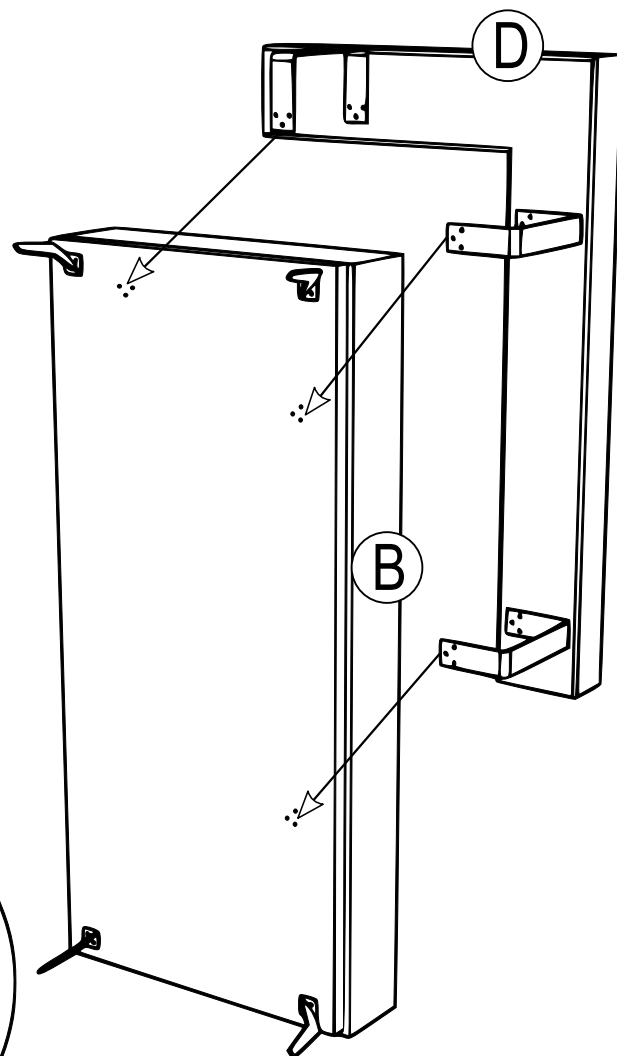

FLORENCE RELAX

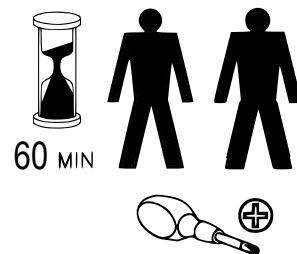
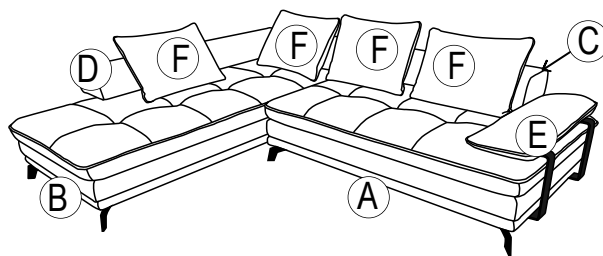

12

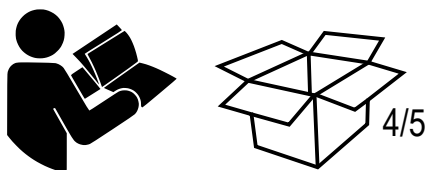

13

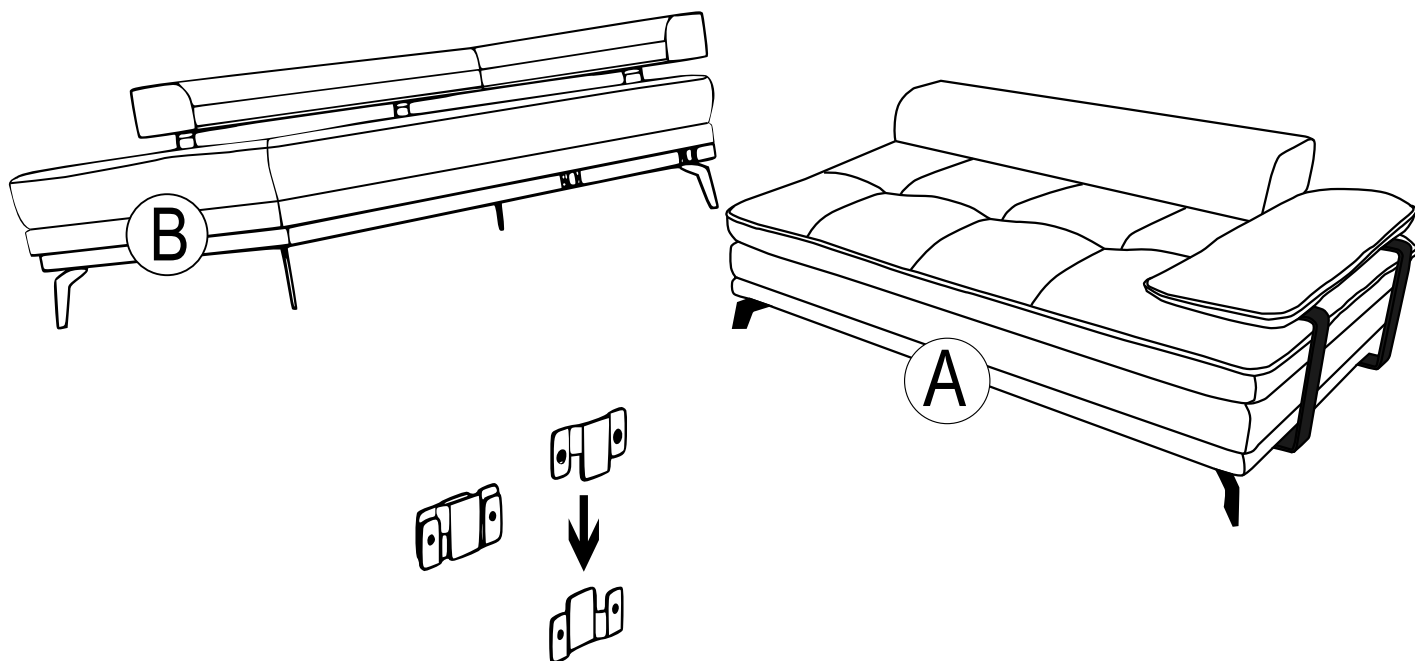

14

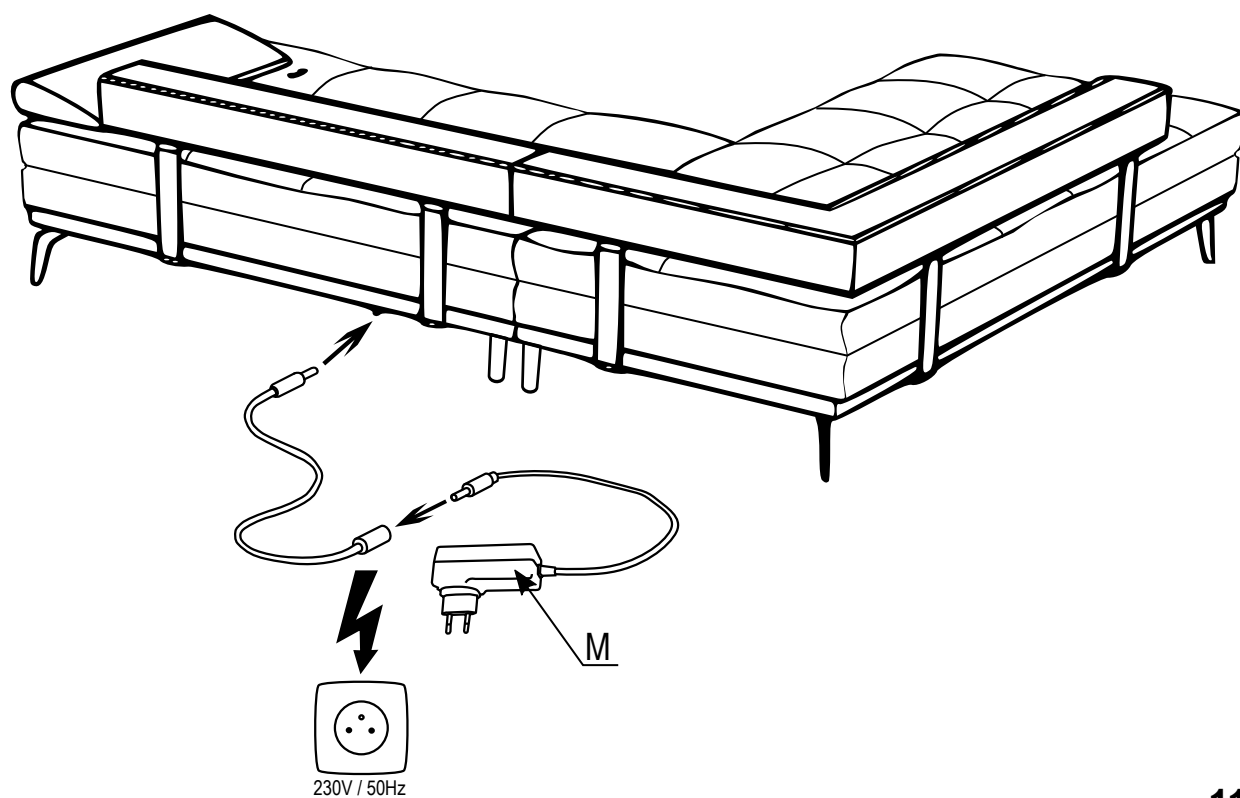

FLORENCE RELAX

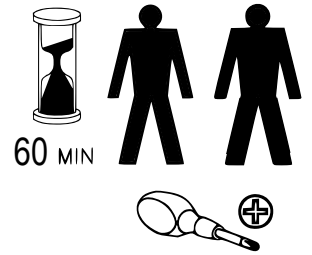
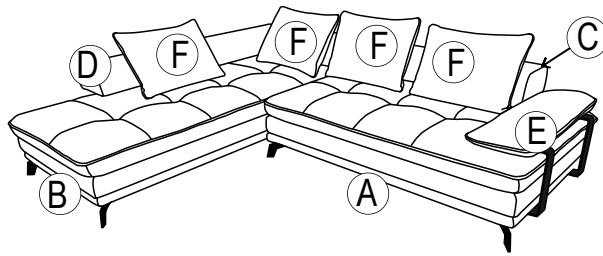

15

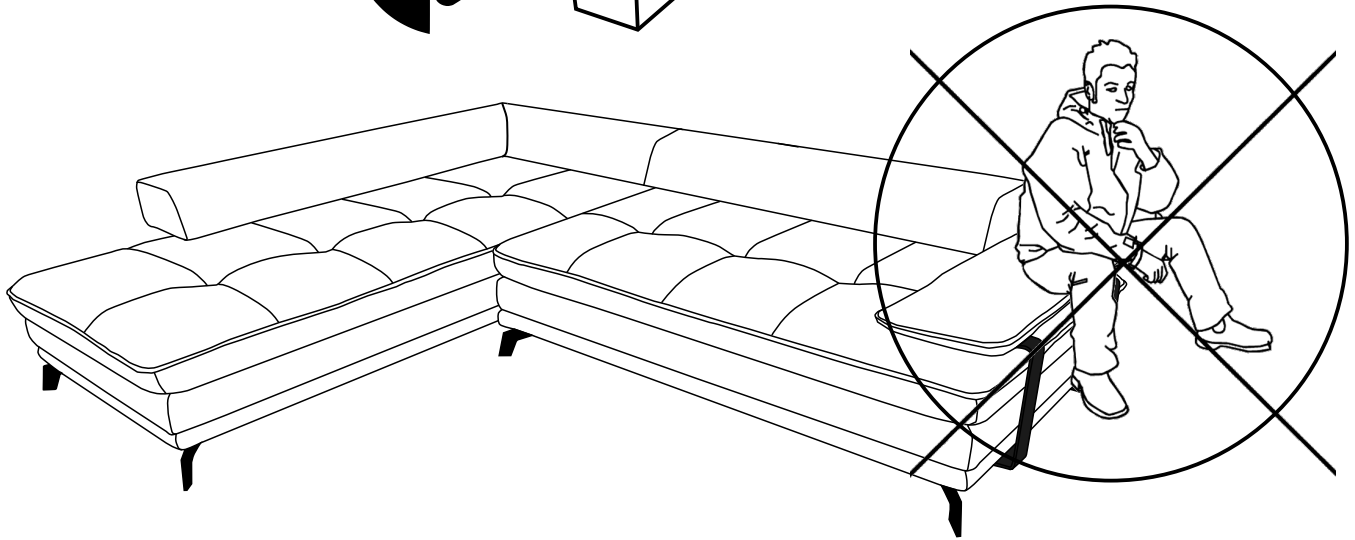
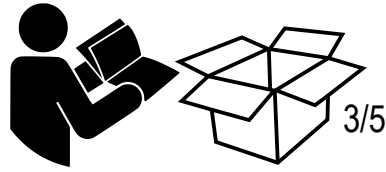

16

