

# MAROLA U-FORM

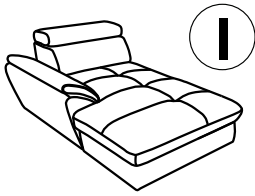

I

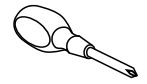
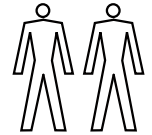
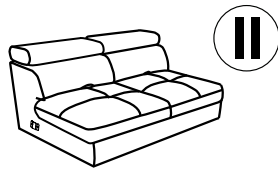

II

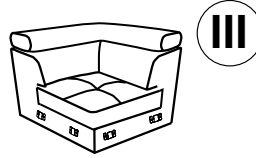

III



IV

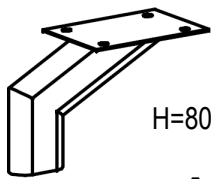

H=80 mm

**A x6**

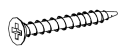

5x25 m

**B x24**



H=80 mm

**C x5**



H=50 mm

**D x4**

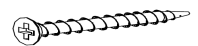

3,5x55 m

**E x8**

1

I

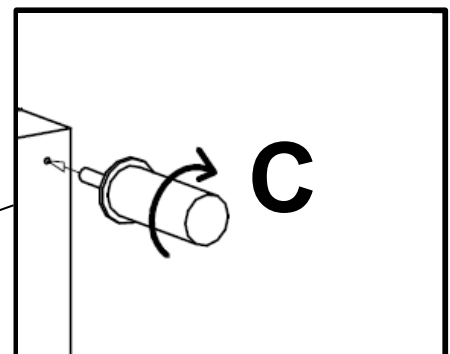
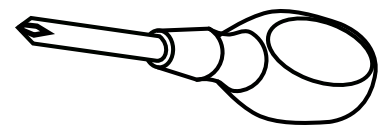
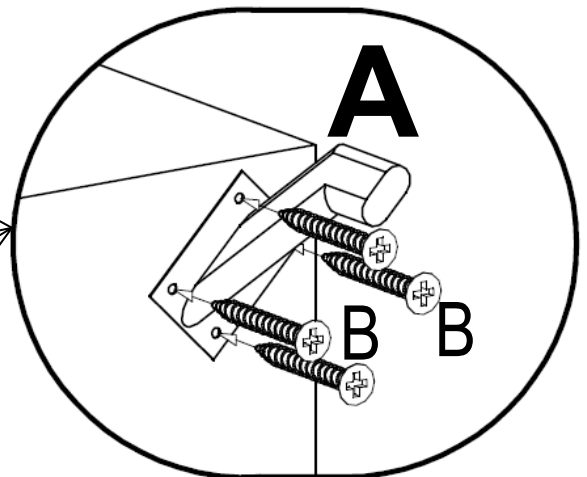
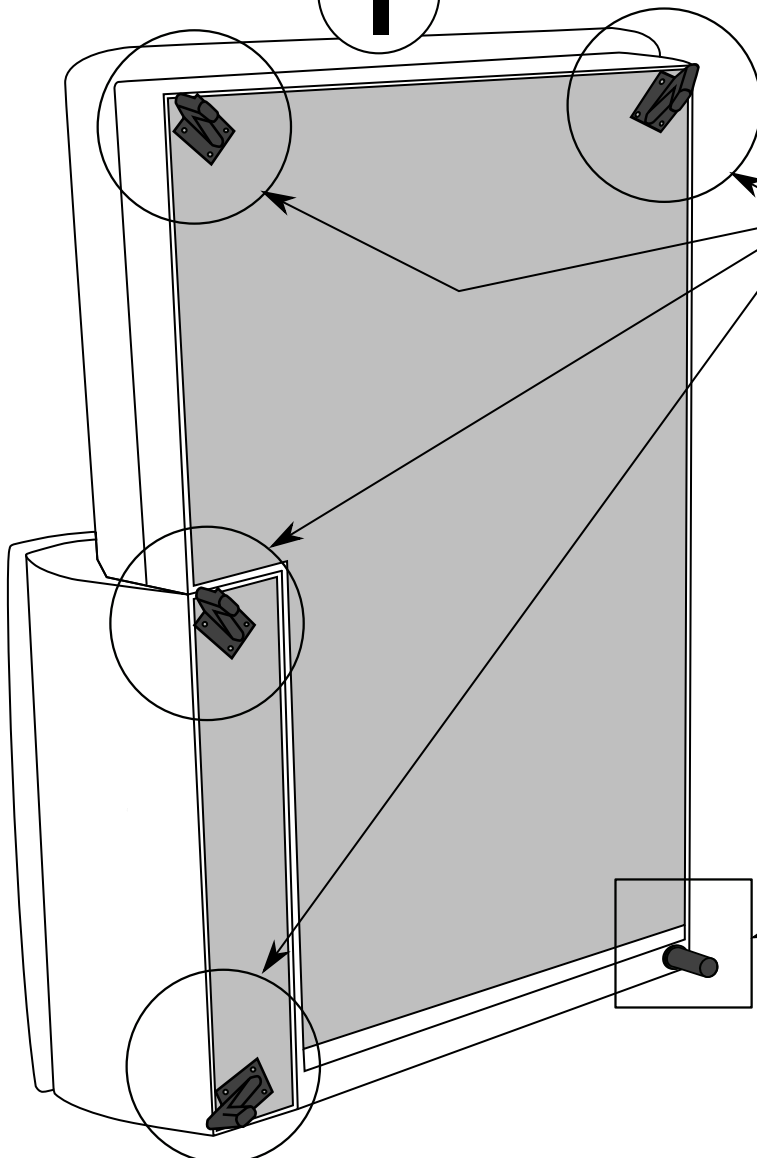

# MAROLA U-FORM

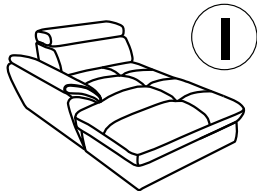
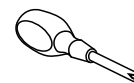
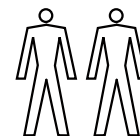
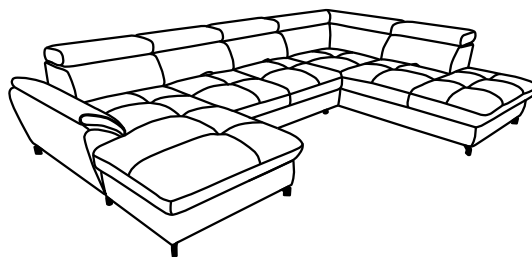

I

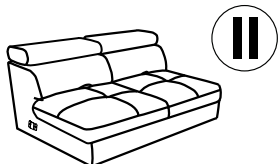

II

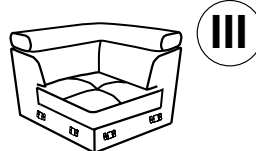

III



IV

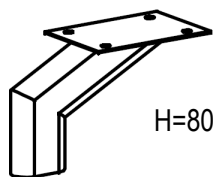

H=80 mm

**A x6**

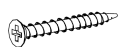

5x25 m

**B x24**

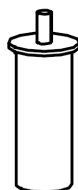

H=80 mm

**C x5**

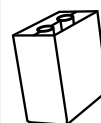

H=50 mm

**D x4**

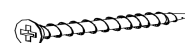

3,5x55 m

**E x8**

2

II

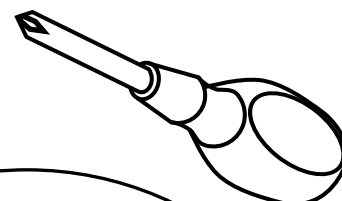
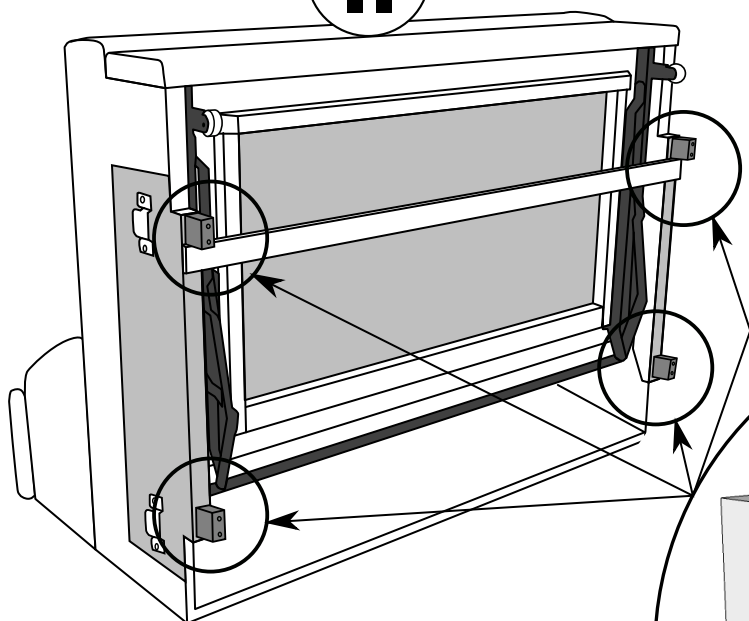

**D**

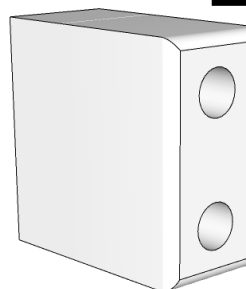

**E**

**E**

# MAROLA U-FORM

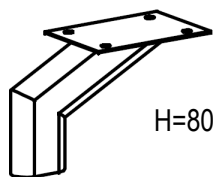
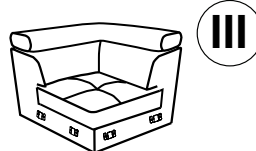
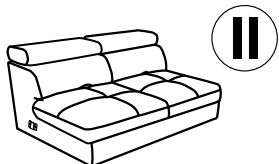
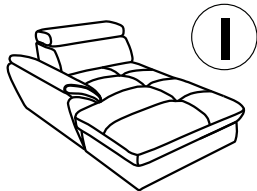
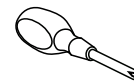
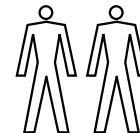
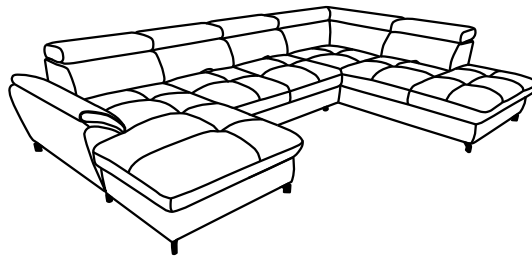

H=80 mm

**A x6**

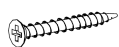

5x25 m

**B x24**

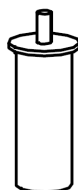

H=80 mm

**C x5**

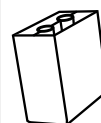

H=50 mm

**D x4**

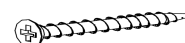

3,5x55 m

**E x8**

3

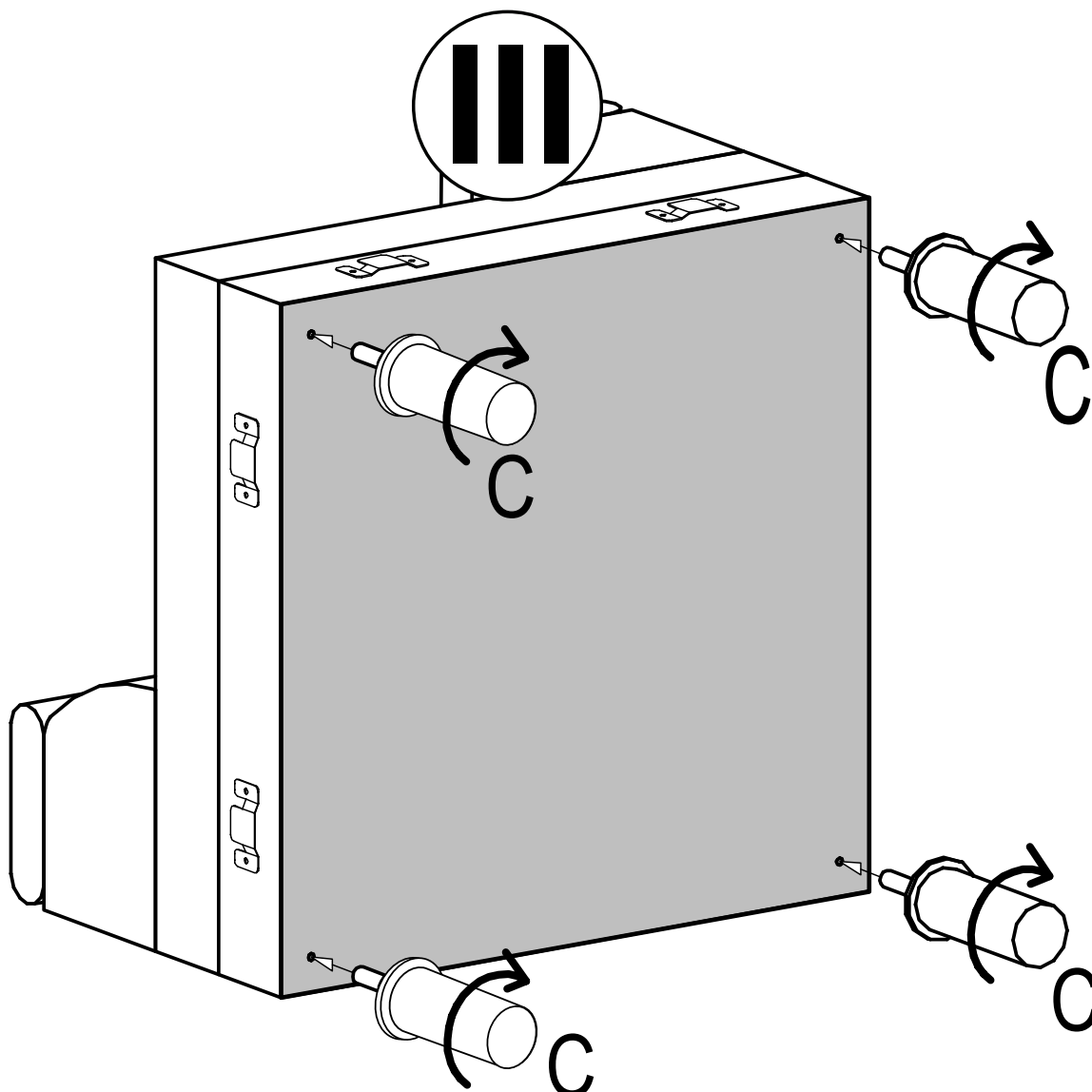

# MAROLA U-FORM

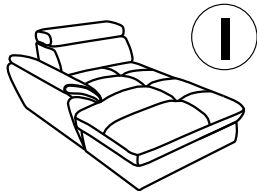
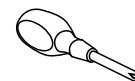
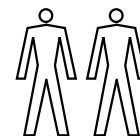
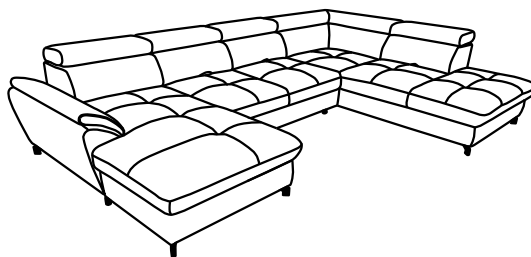

I

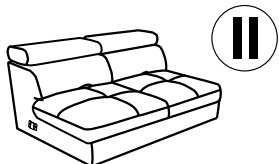

II

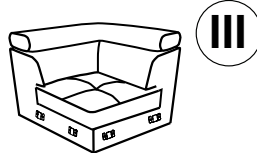

III



IV

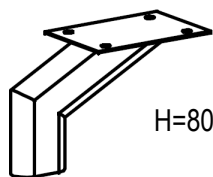

H=80 mm

**A x6**

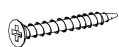

5x25 m

**B x24**

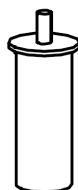

H=80 mm

**C x5**



H=50 mm

**D x4**

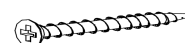

3,5x55 m

**E x8**

4

**IV**

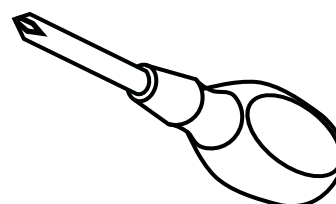
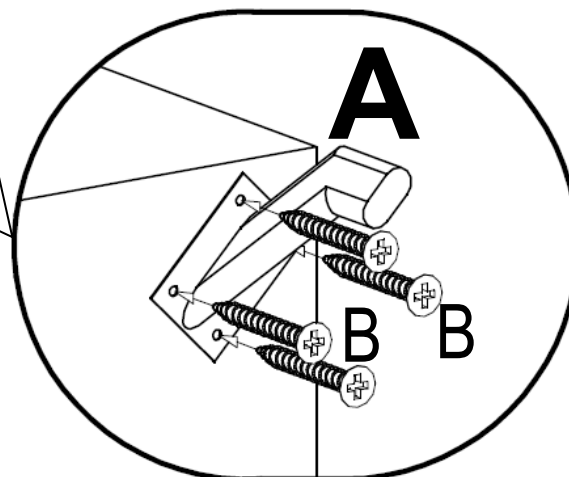
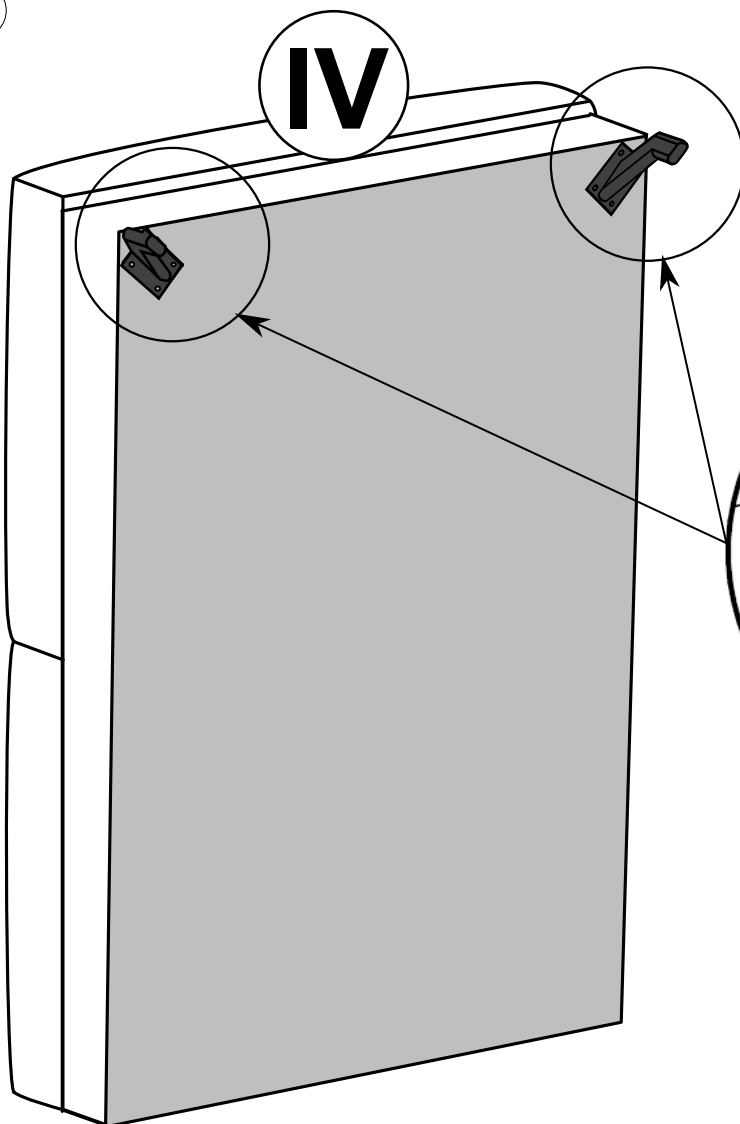

# MAROLA U-FORM

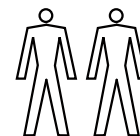
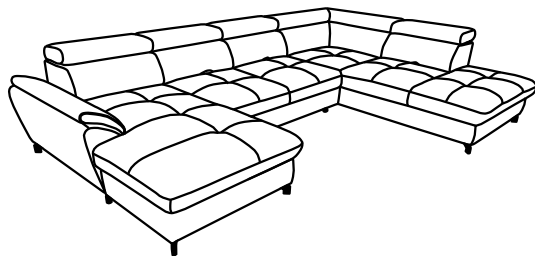

5a

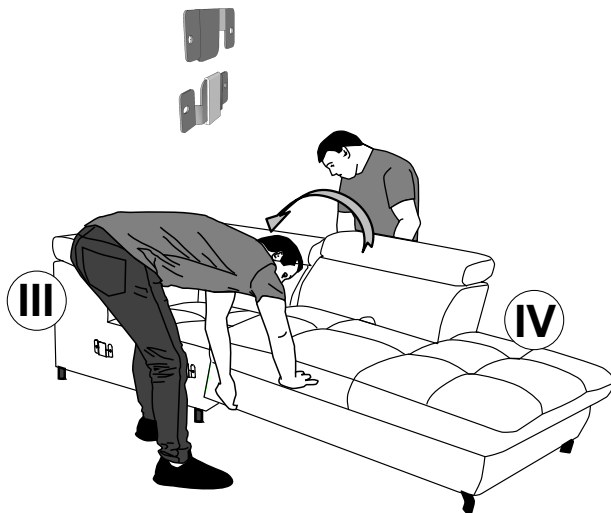

5b

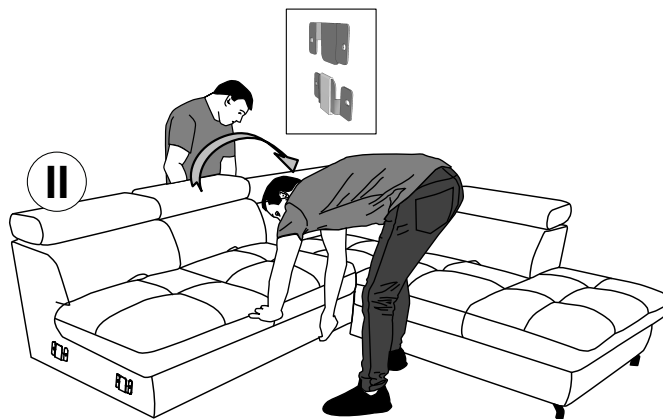

5c

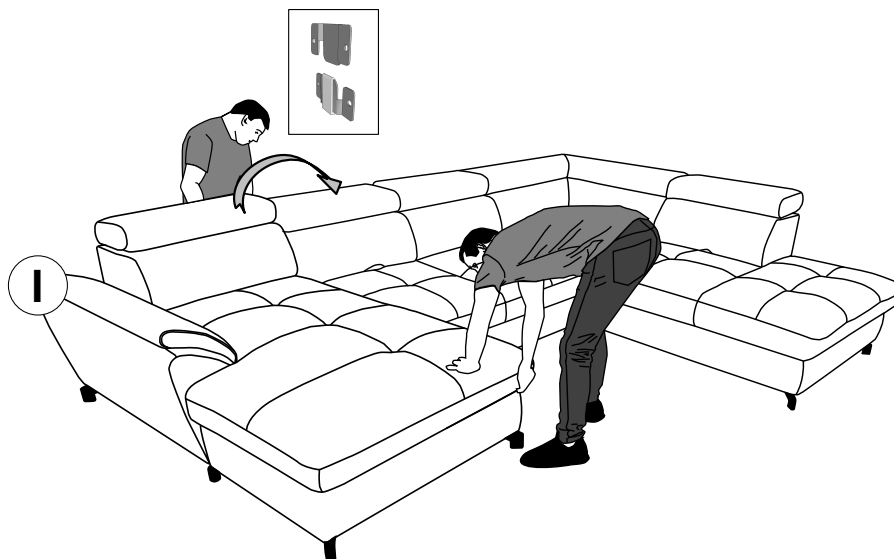

# MAROLA U-FORM

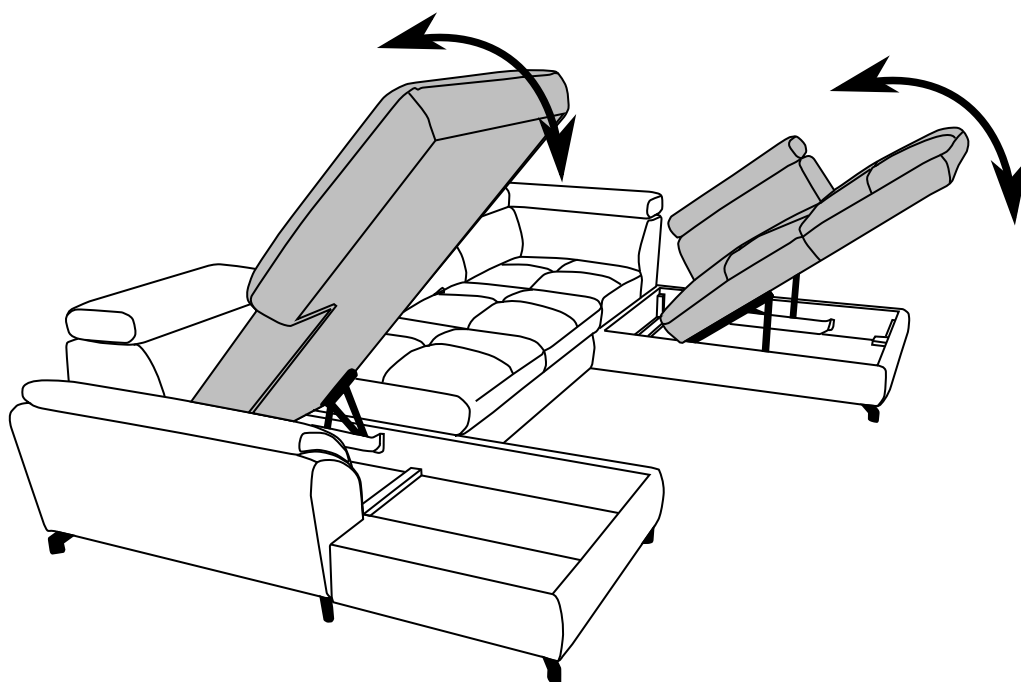
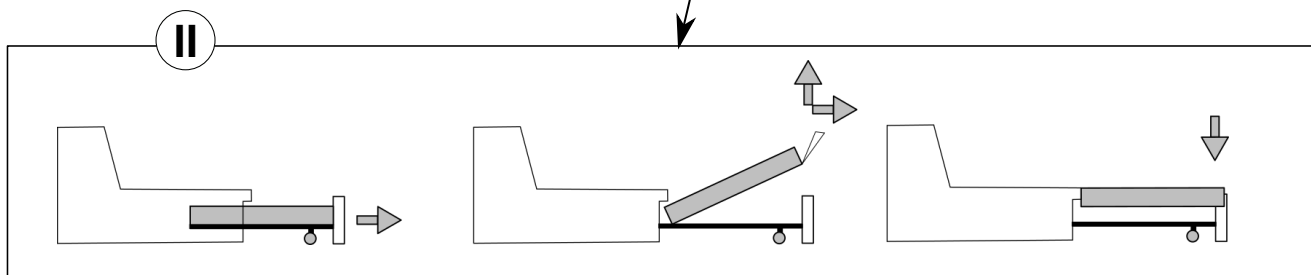
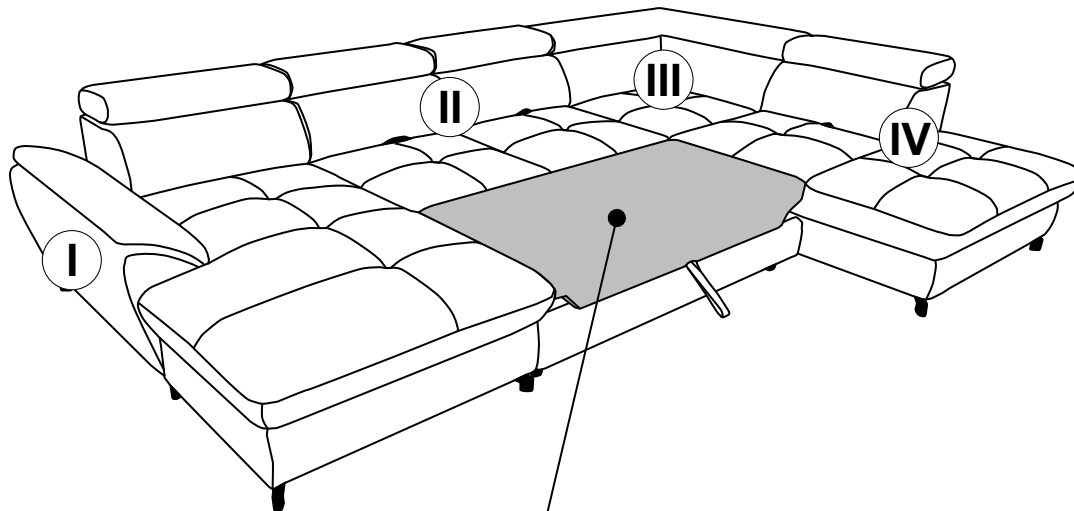
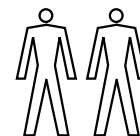
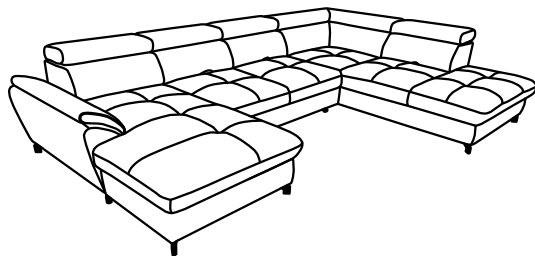

# MAROLA U-FORM

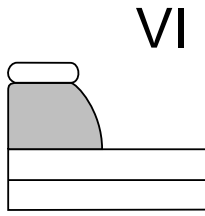
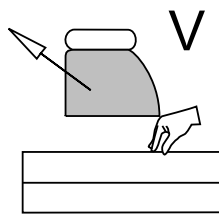
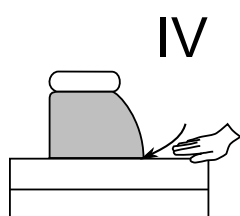
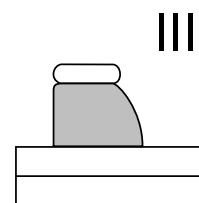
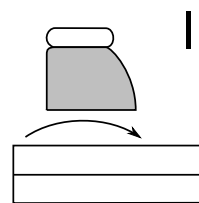
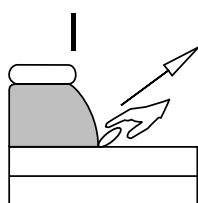
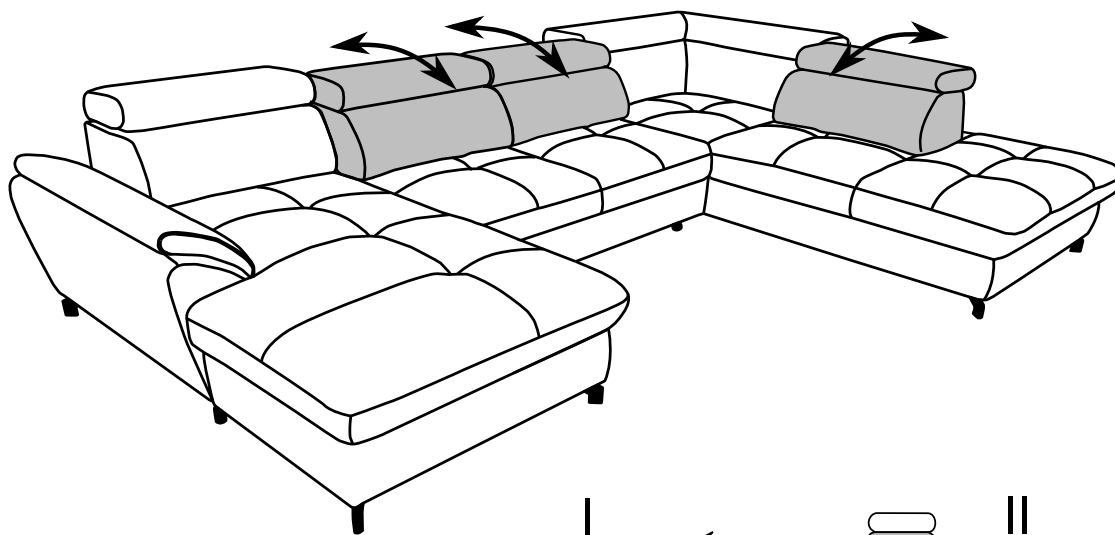
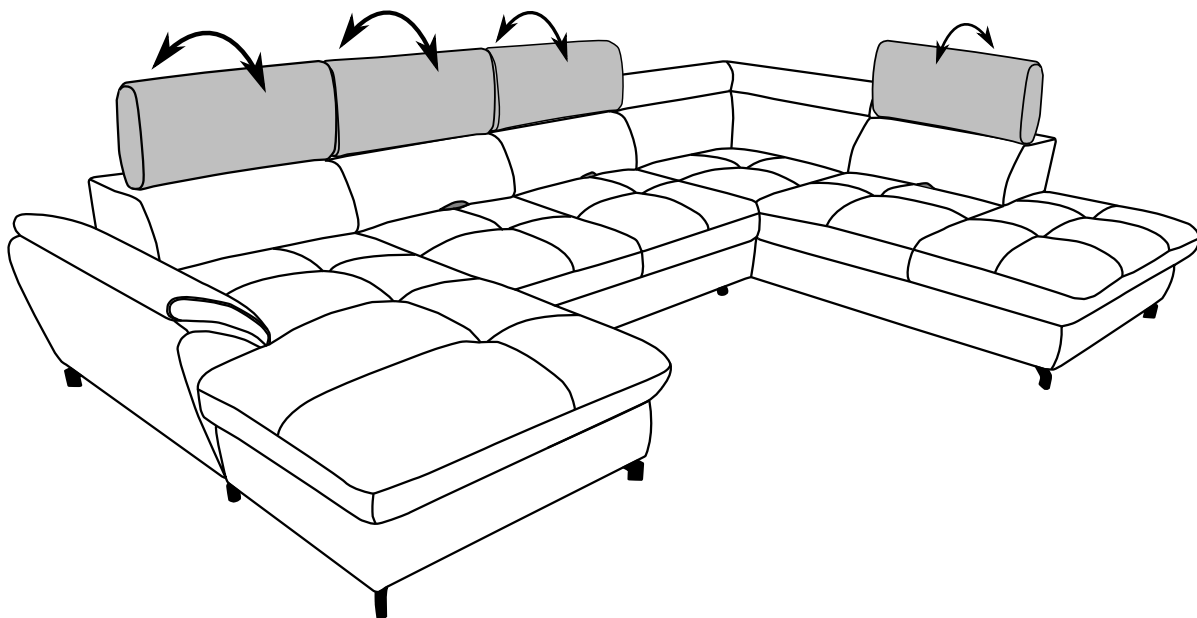
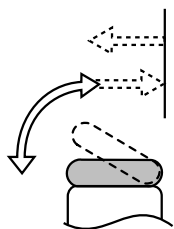
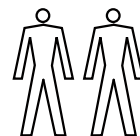
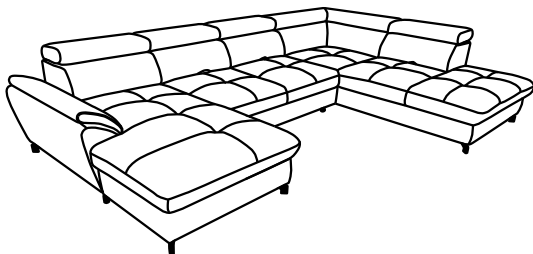

# MAROLA U-FORM

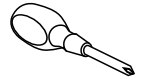
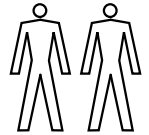
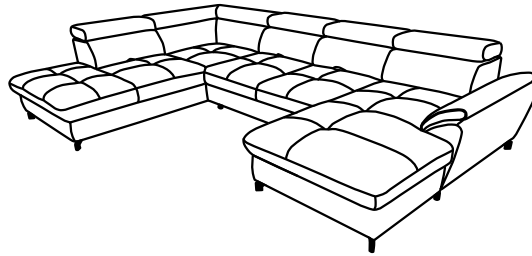

I



II



III



IV

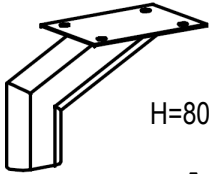

H=80 mm

**A x6**

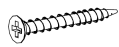

5x25 m

**B x24**



H=80 mm

**C x5**



H=50 mm

**D x4**

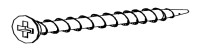

3,5x55 m

**E x8**

1

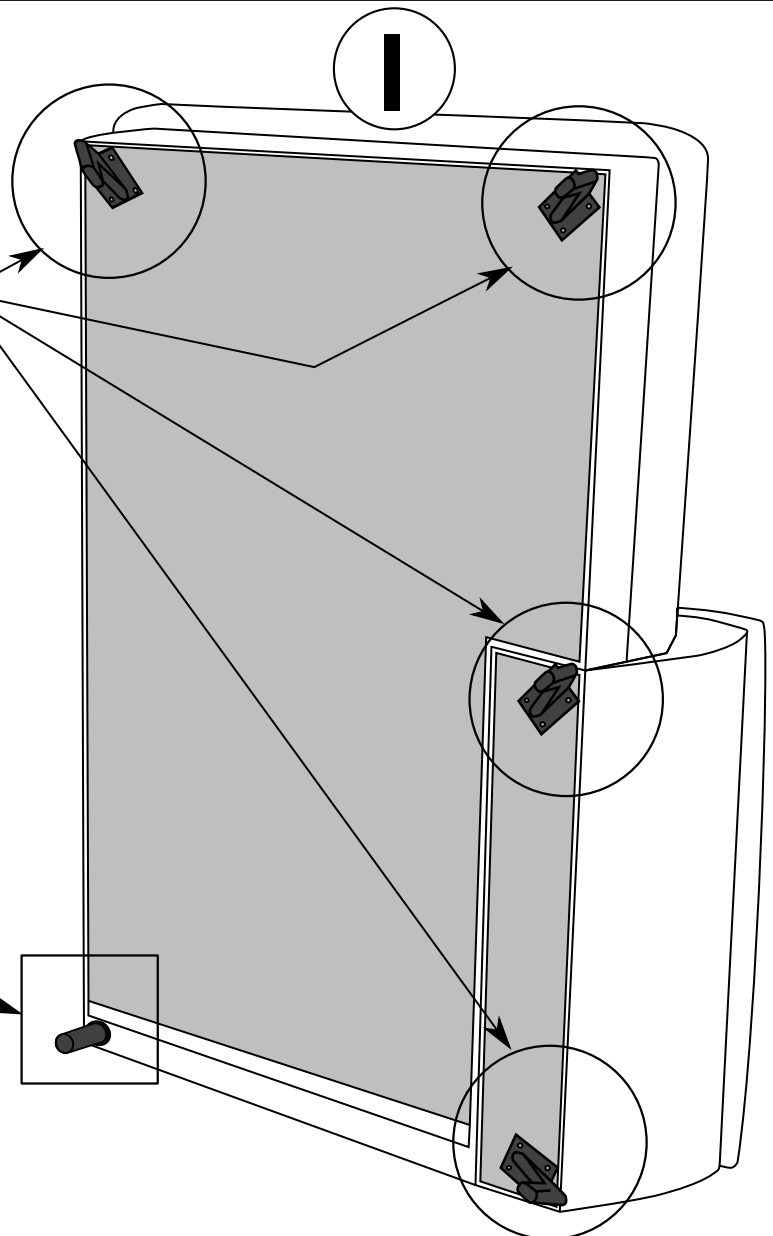
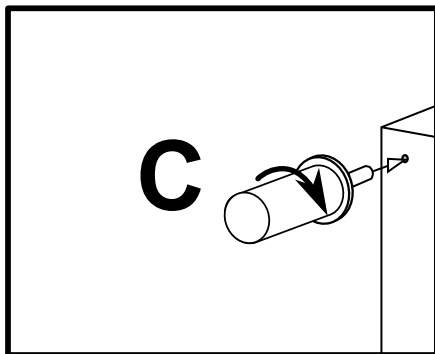
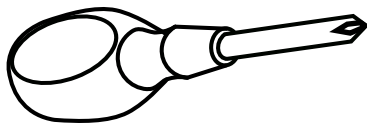
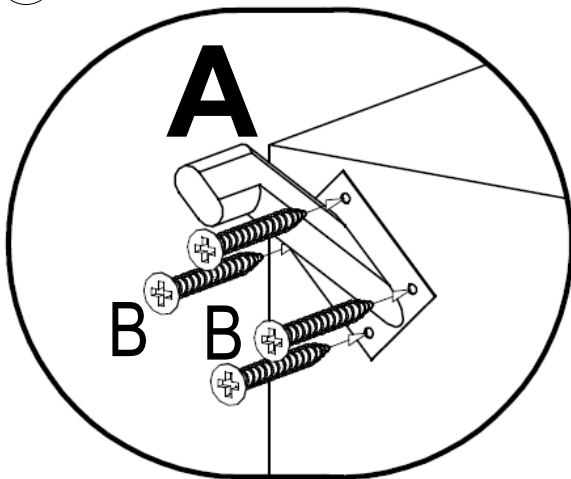



# MAROLA U-FORM

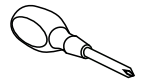
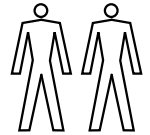
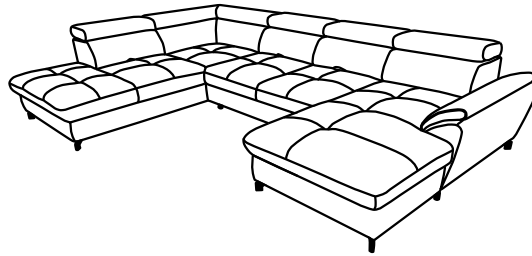

I



II



III

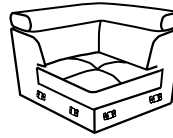

IV

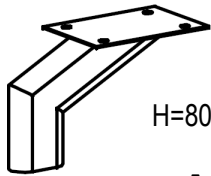
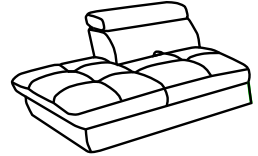

H=80 mm

**A x6**



5x25 m

**B x24**



H=80 mm

**C x5**



H=50 mm

**D x4**

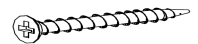

3,5x55 m

**E x8**

2

II

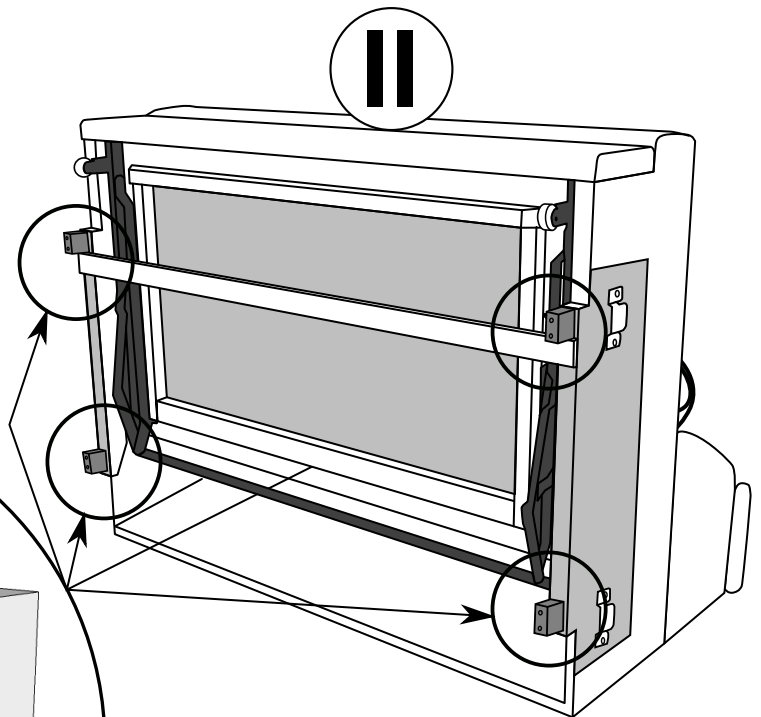

**D**

**E**

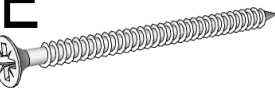

**E**

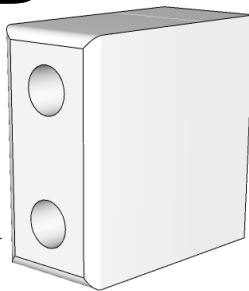

# MAROLA U-FORM

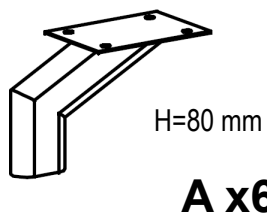
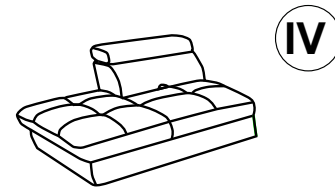
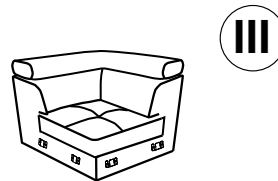
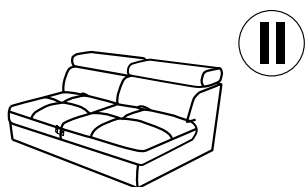
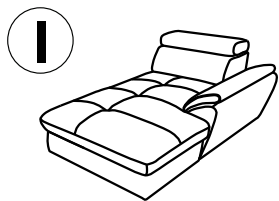
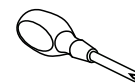
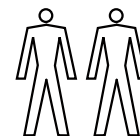
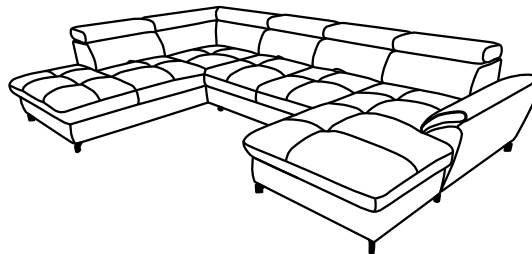

H=80 mm

**A x6**



5x25 m

**B x24**

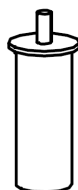

H=80 mm

**C x5**



H=50 mm

**D x4**

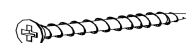

3,5x55 m

**E x8**

**3**

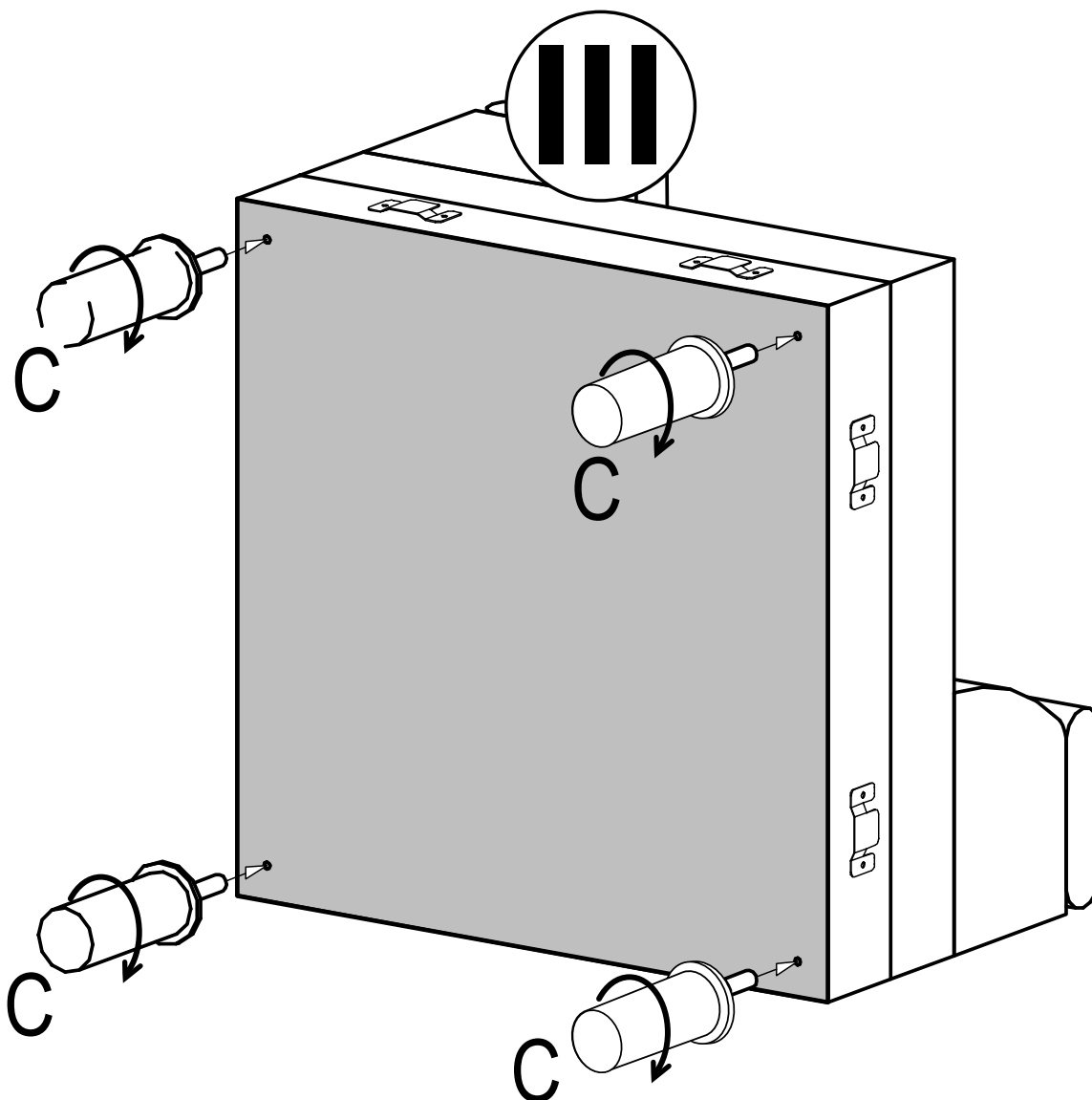

# MAROLA U-FORM

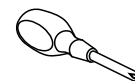
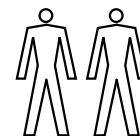
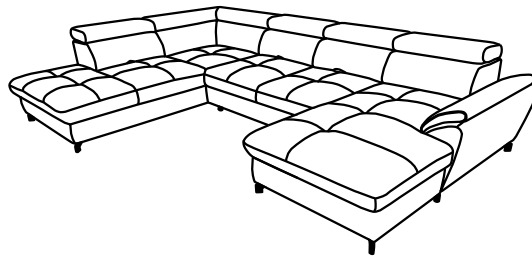

I



II



III

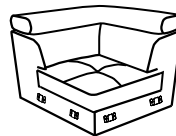

IV

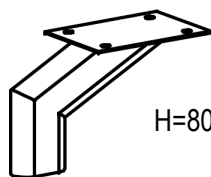

H=80 mm

**A x6**

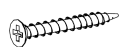

5x25 m

**B x24**

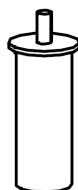

H=80 mm

**C x5**

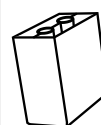

H=50 mm

**D x4**

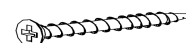

3,5x55 m

**E x8**

4

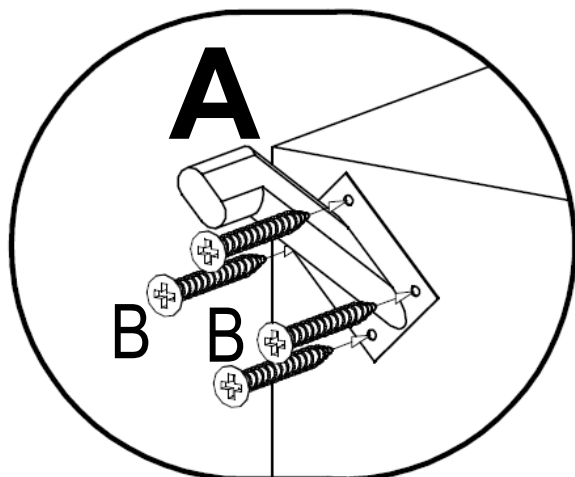

**B**

**B**

**IV**

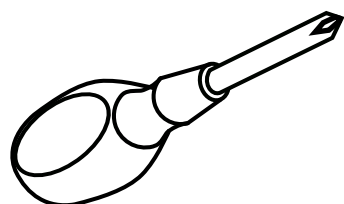

# MAROLA U-FORM

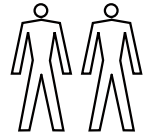
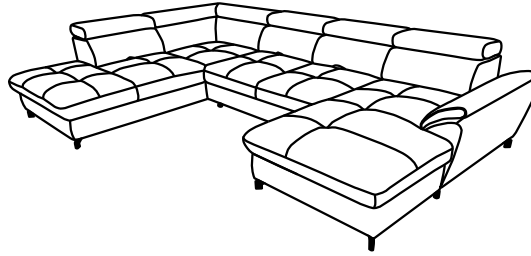

5a

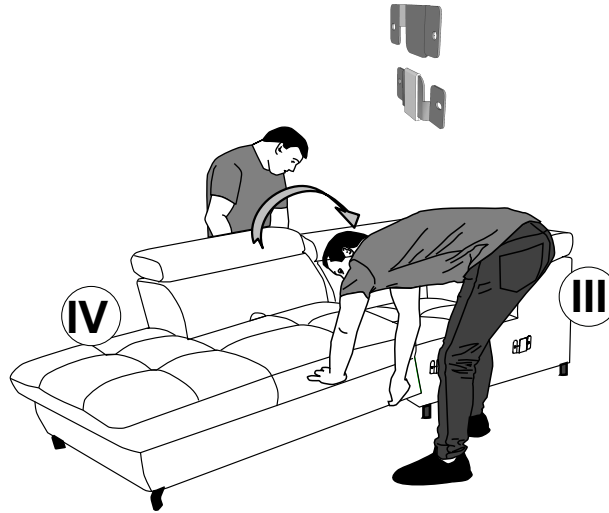

5b

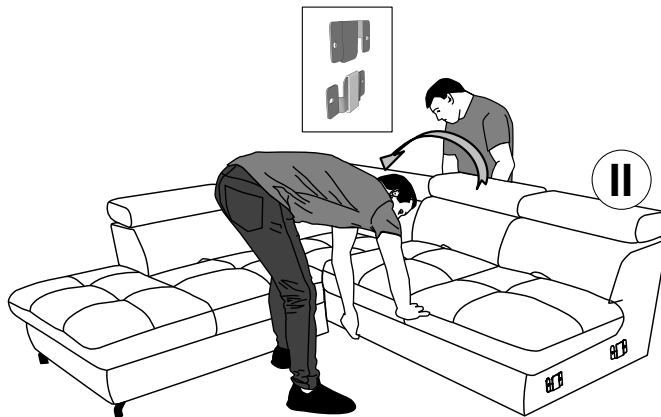

5c

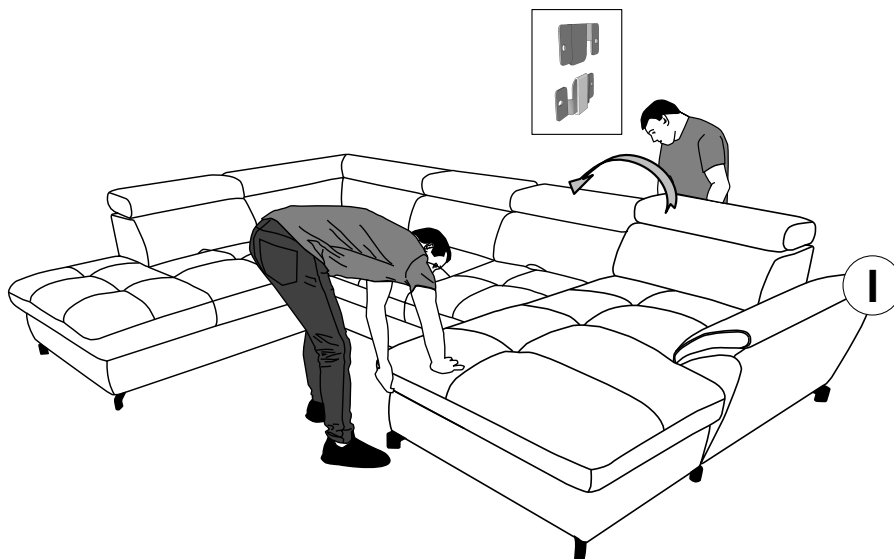

# MAROLA U-FORM

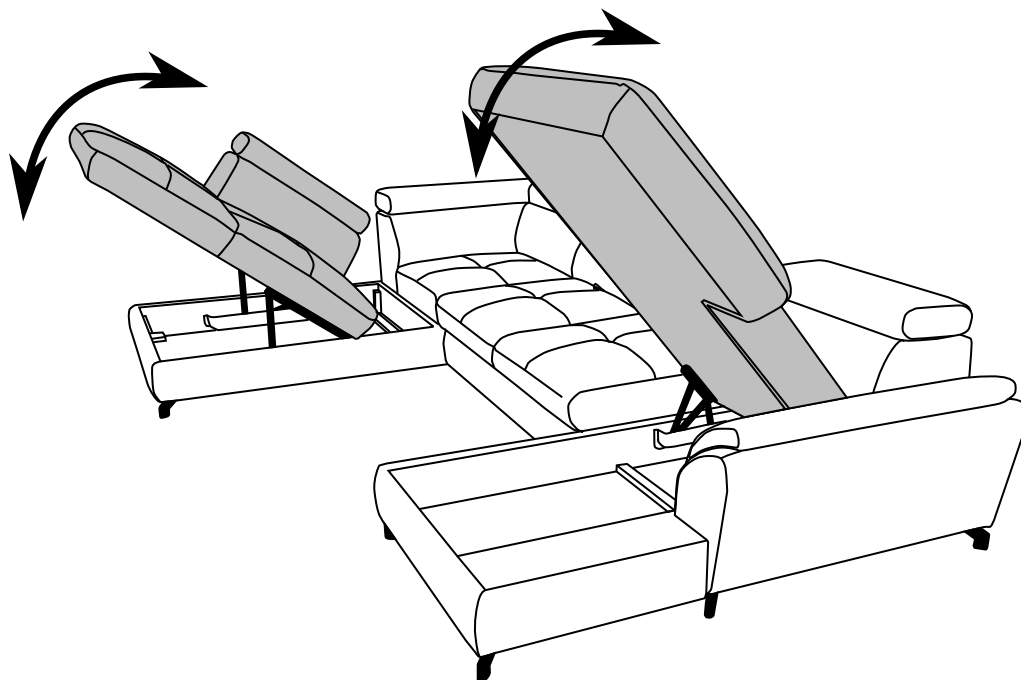
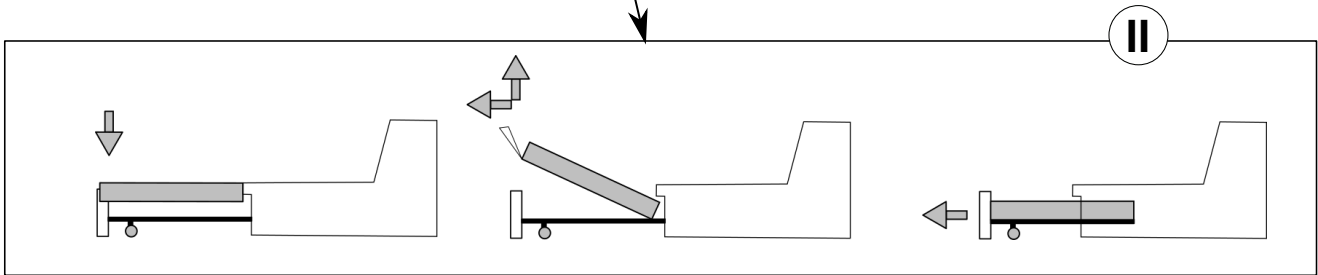
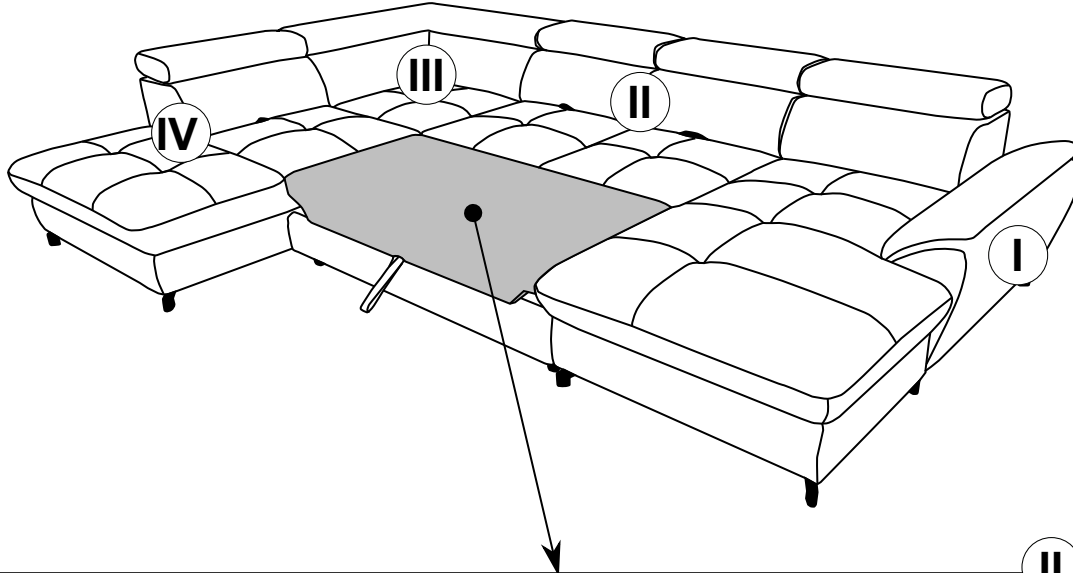
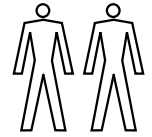
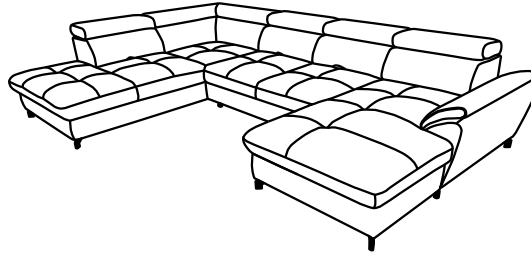

# MAROLA U-FORM

