

# REMO RM 2

PRODUCENT/PRODUCER/Výrobce/Výrobca:  
 FABRYKA MEBLI "MEBLAR" SP. J  
 63-604 Baranów ul. Budka 7 Polska  
 biuro@meblar.com.pl  
 tel. + 48 62 791 20 41

MADE IN POLAND

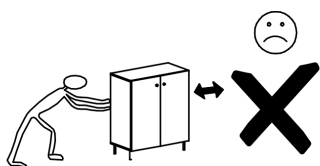
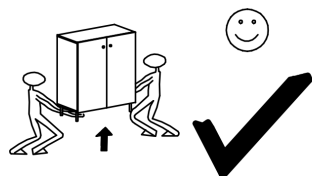
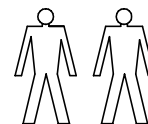
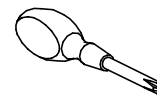
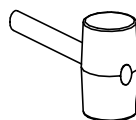
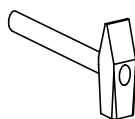
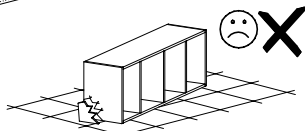
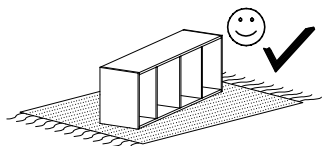

1950

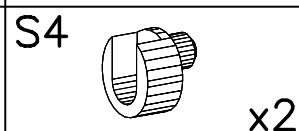
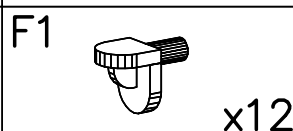
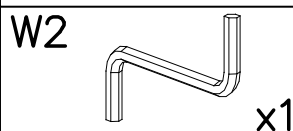
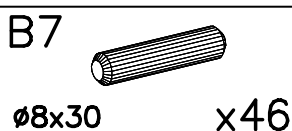
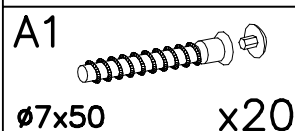
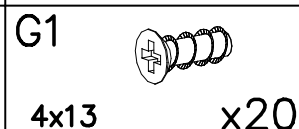
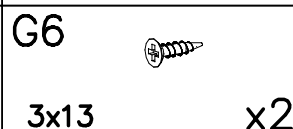
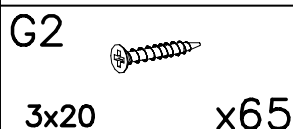
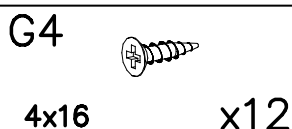
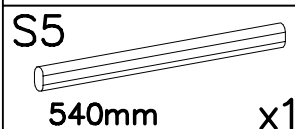
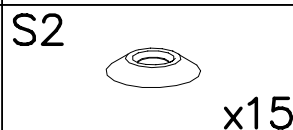
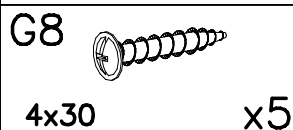
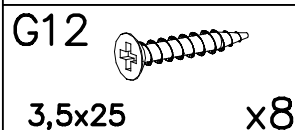
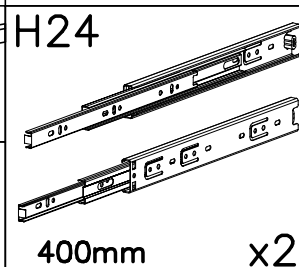
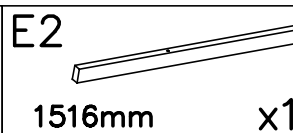
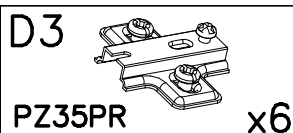
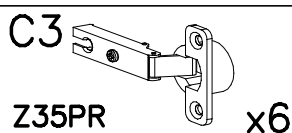
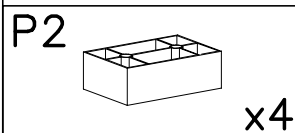
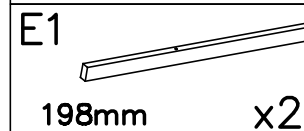
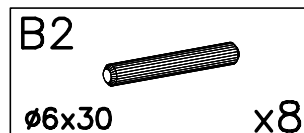
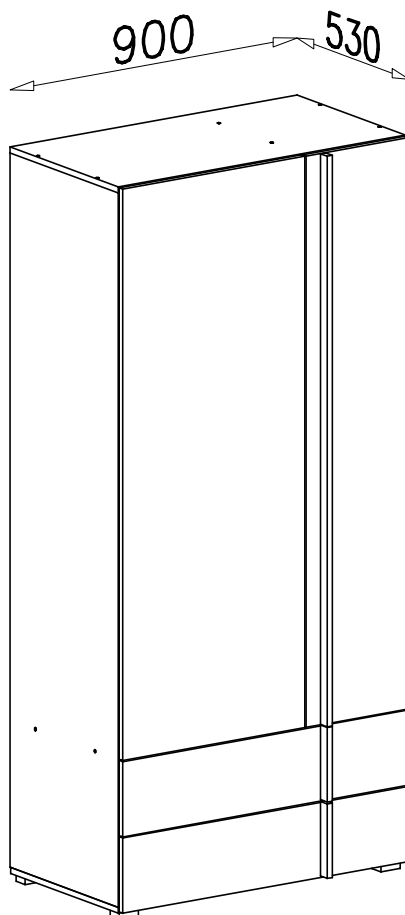

I

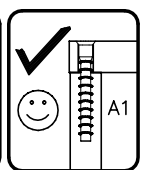
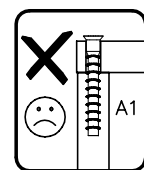
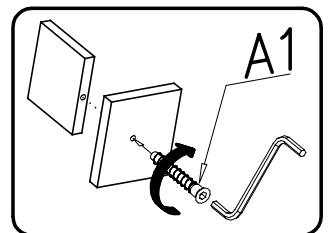
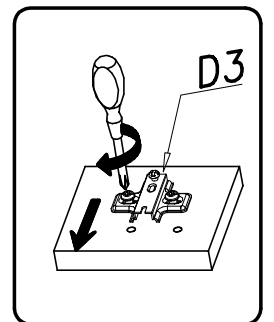
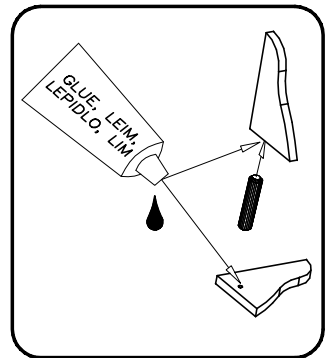
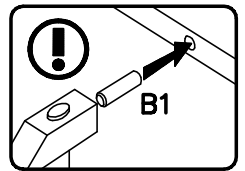
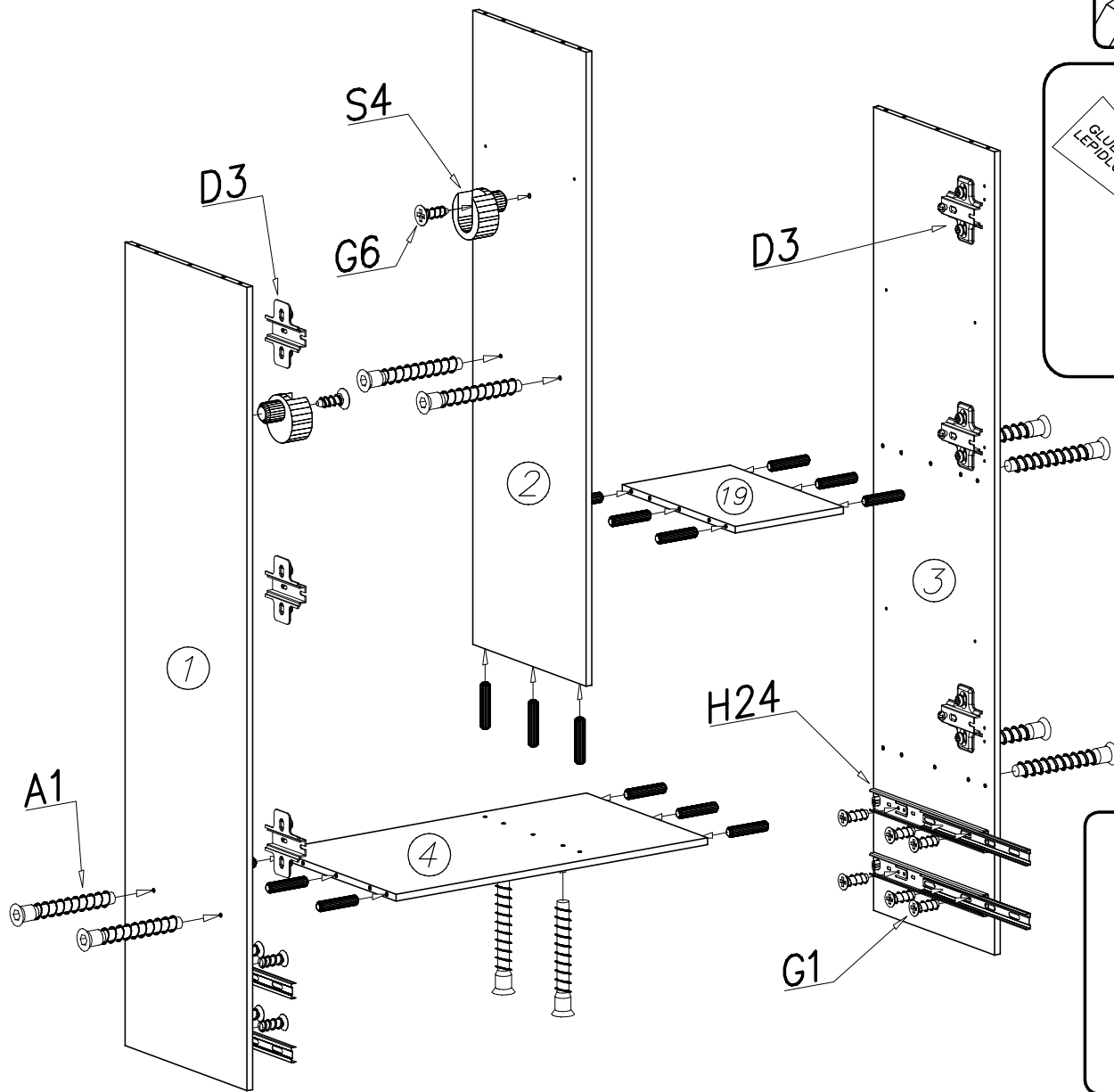

A

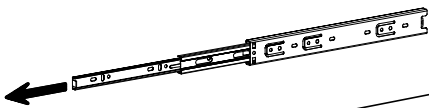

B

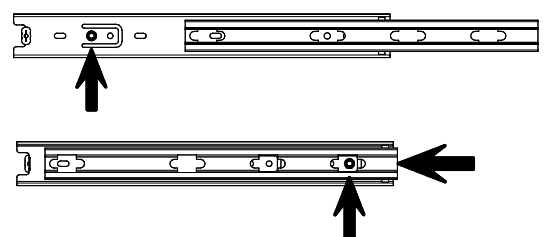
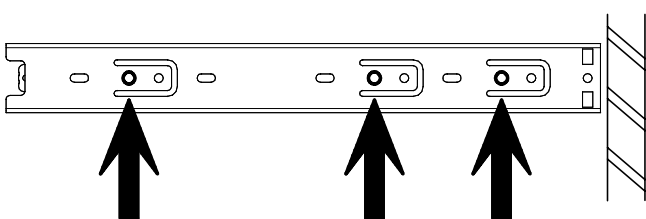
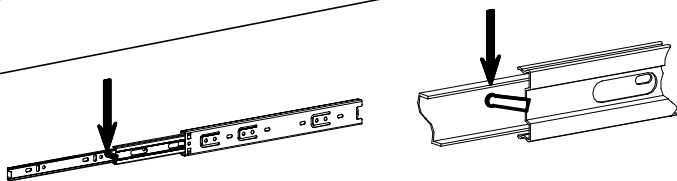

II

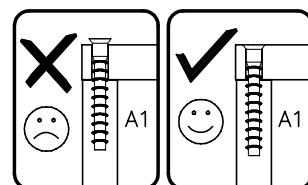
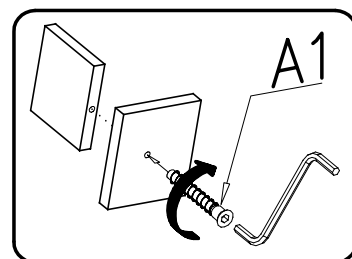
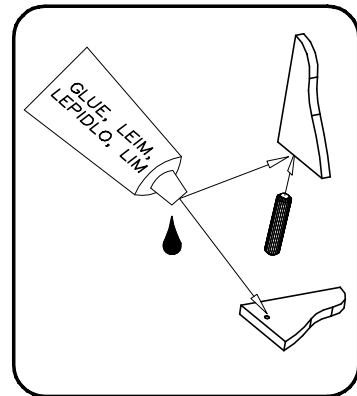
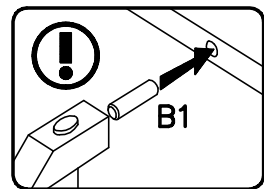
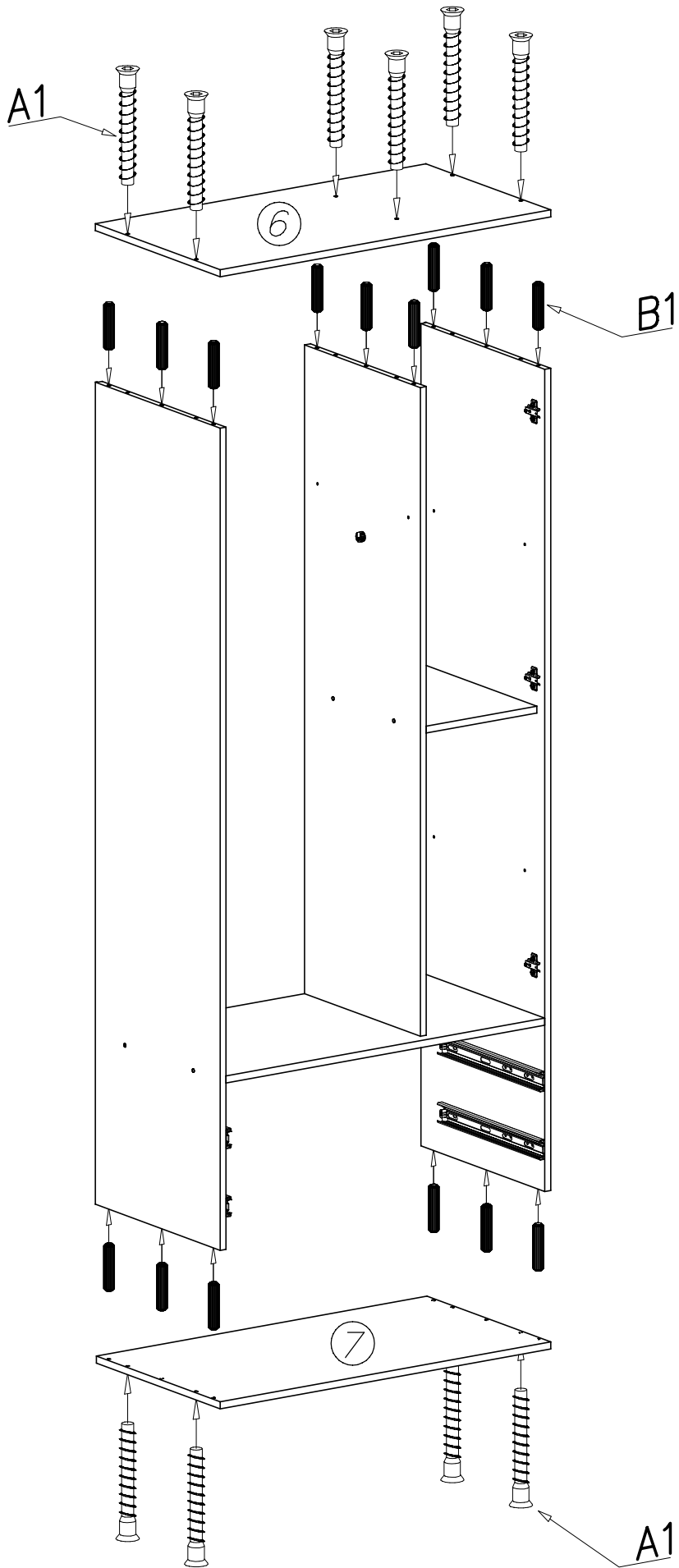

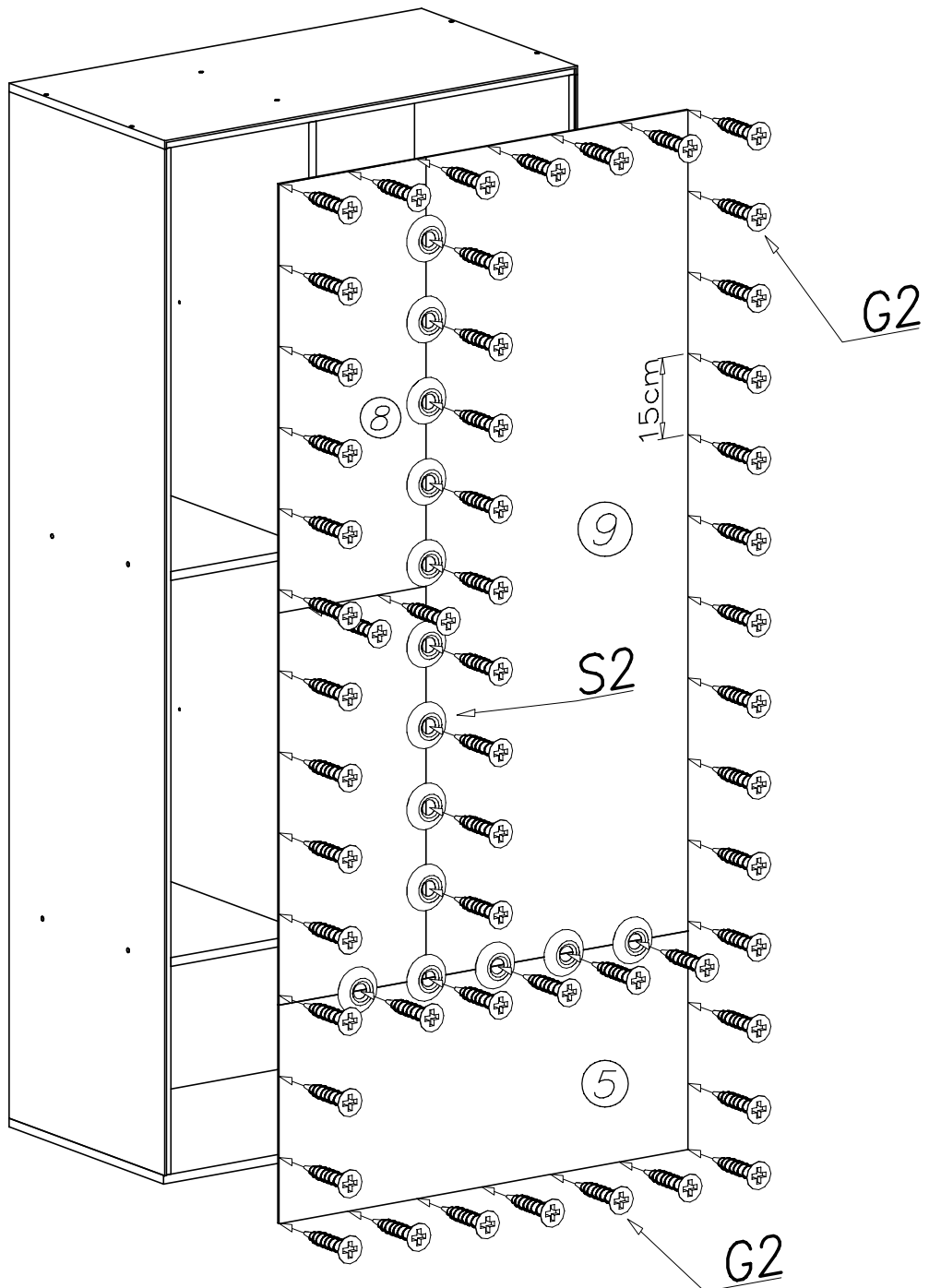
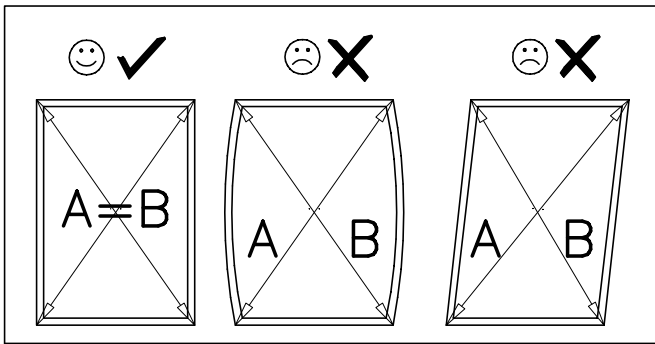

IV

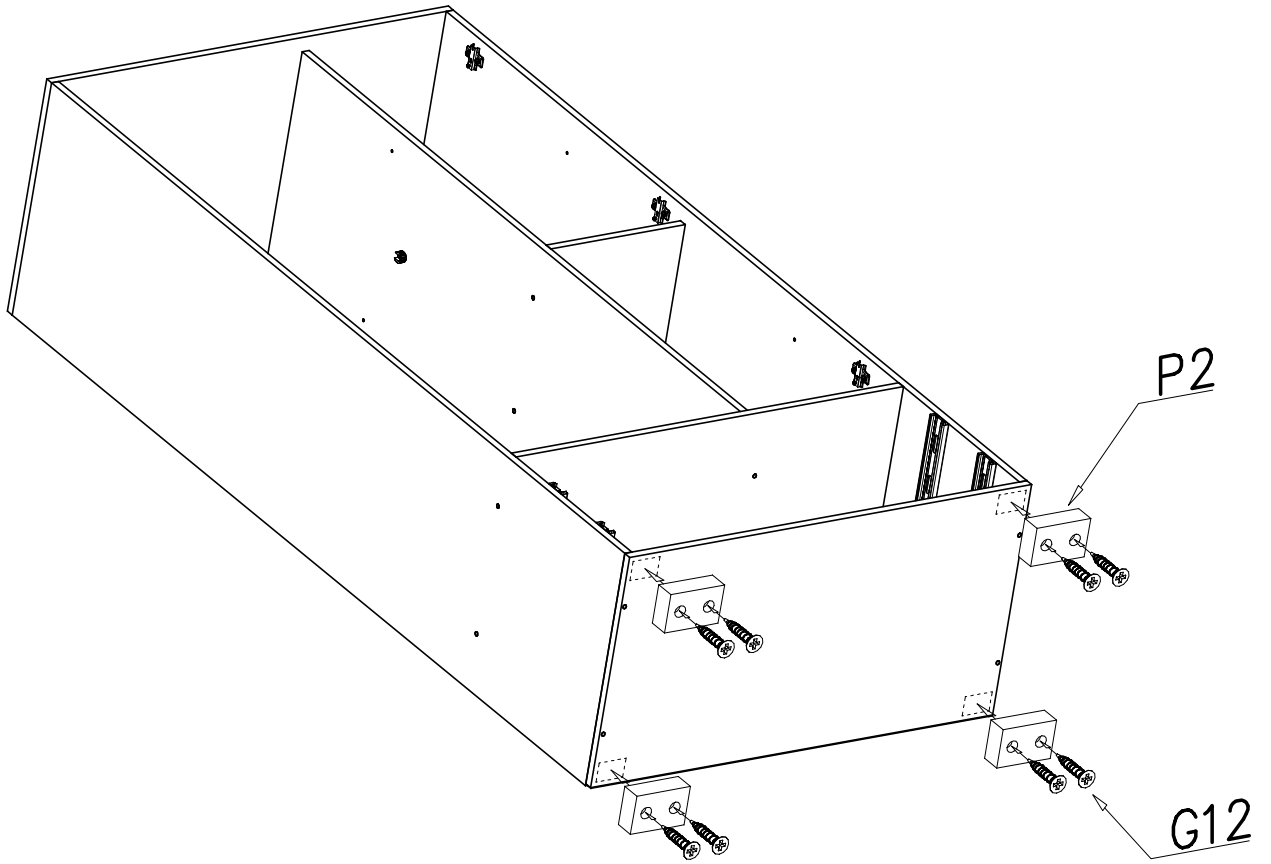

V

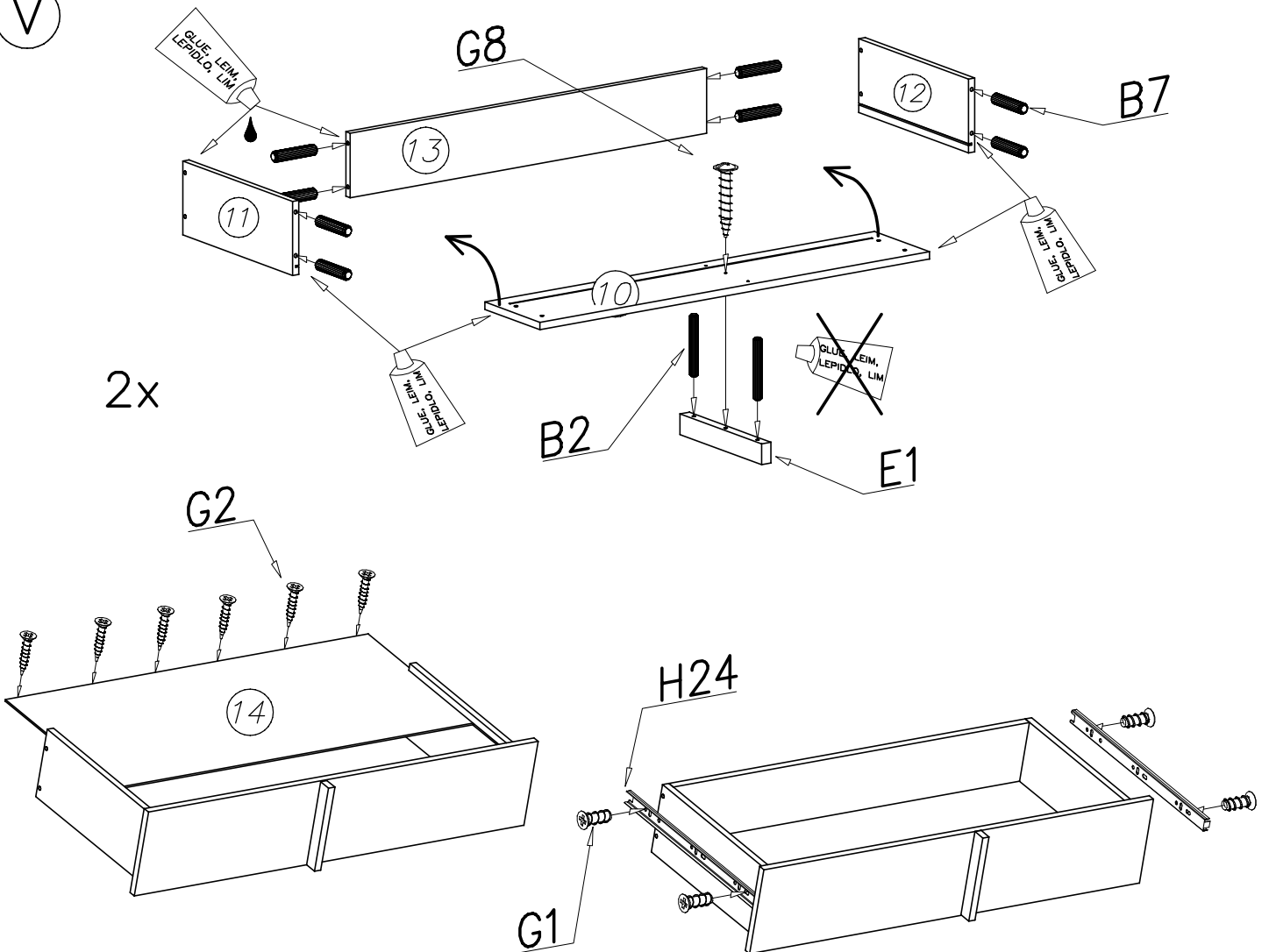

VI

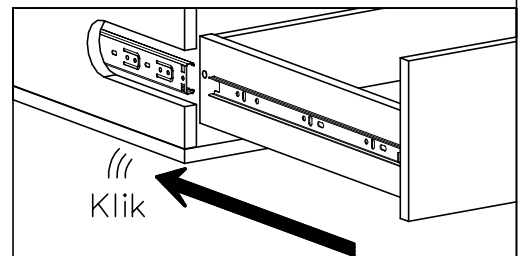
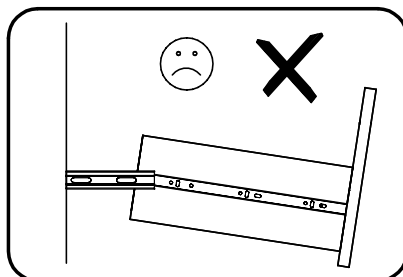
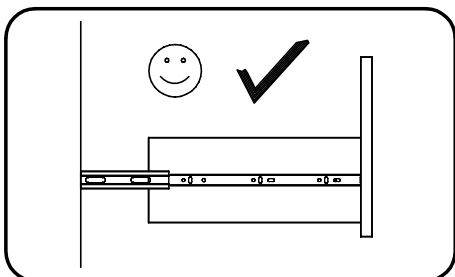
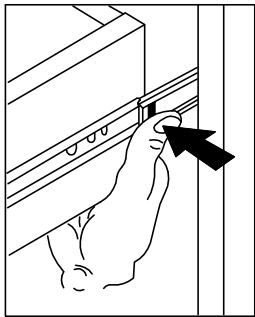
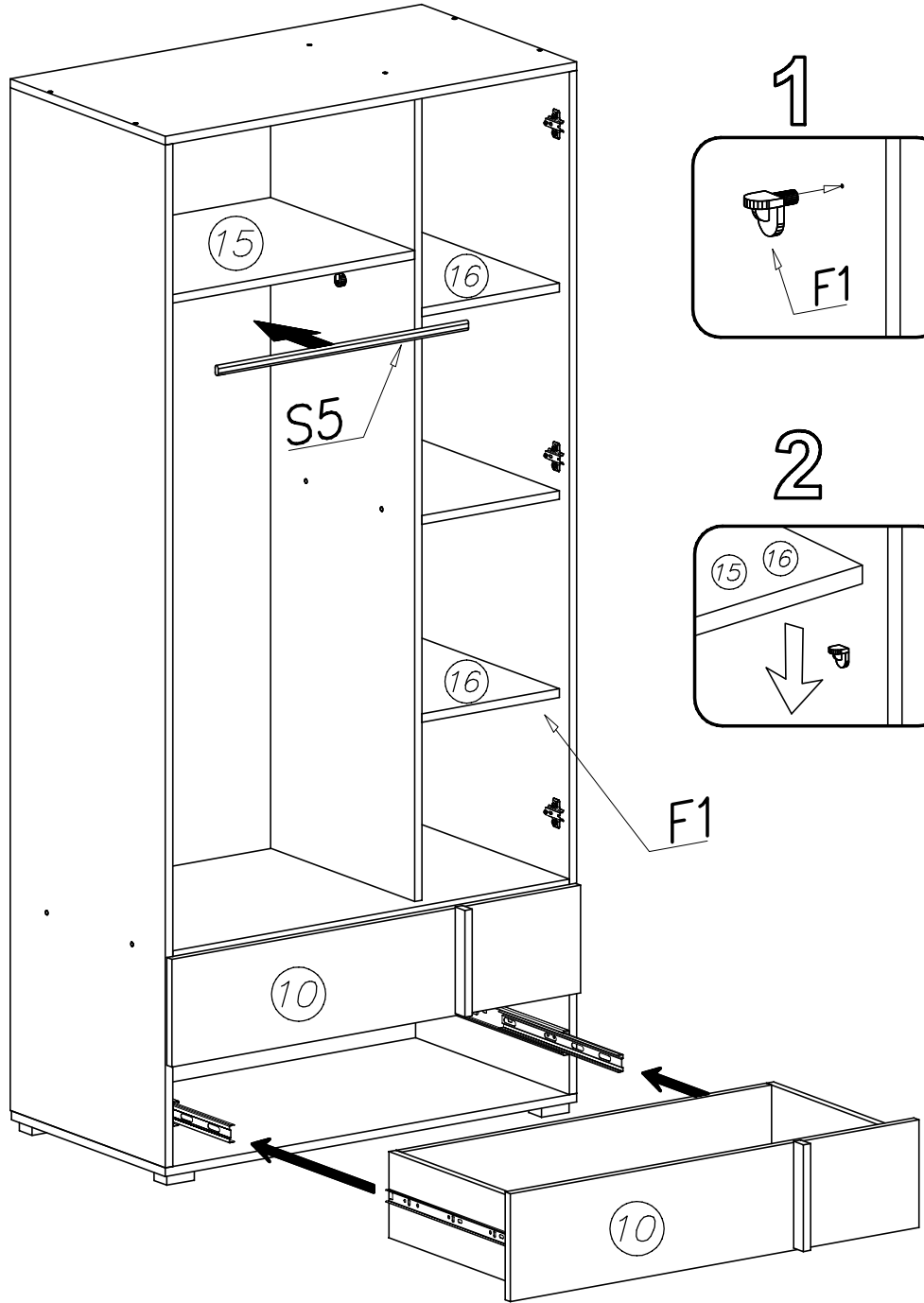
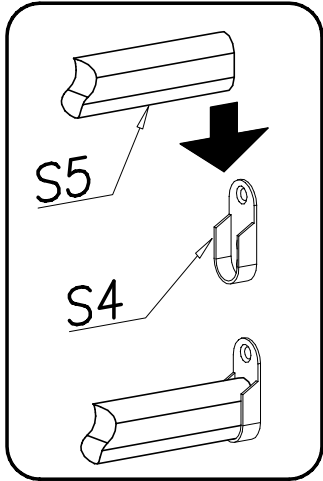

VII

