

# Instrukcja montażu mebli «DOORSET»

Regał otwarty wiszący 80

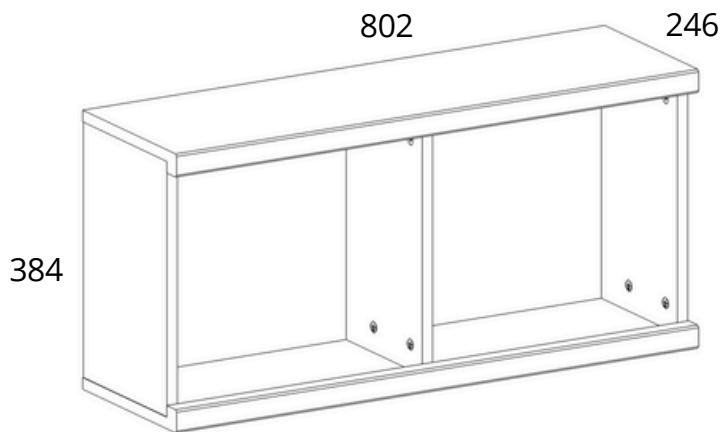

---

Production date  
Data produkcji

---

Stamp of Quality Department  
Pieczęć Działu Jakości

№	L, mm	B, mm	H, mm	Q	№ pack
5	802	246	32	2	1/1
101	352	219	16	1	1/1
102	352	219	16	1	1/1
144	352	199	16	1	1/1
288	780	365	2,5	1	1/1

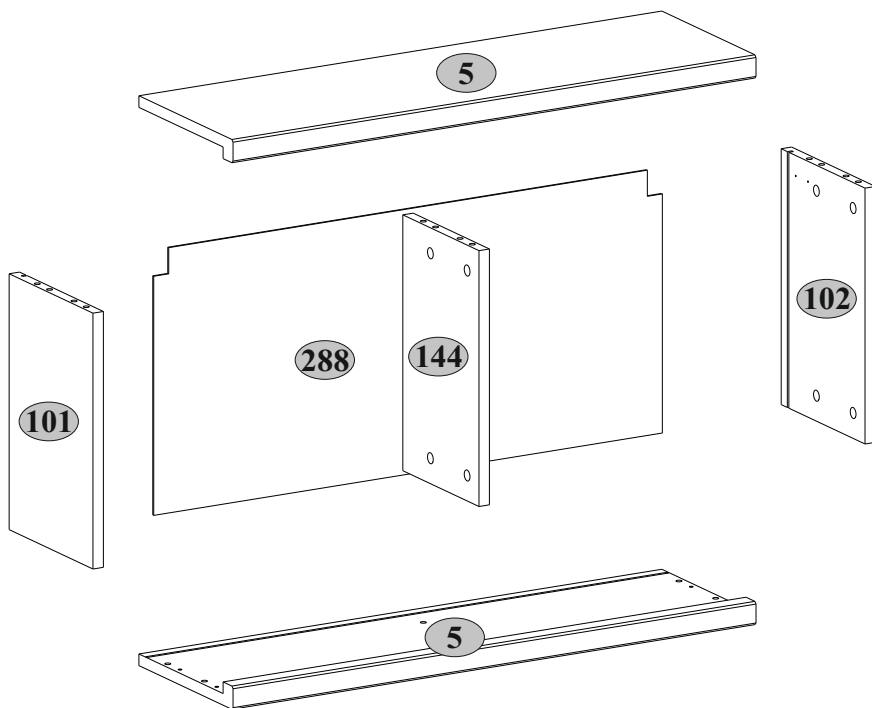

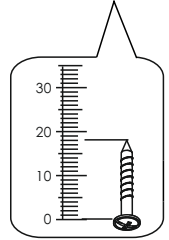
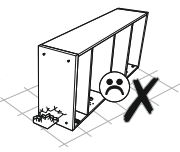
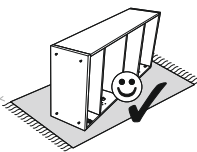
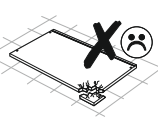
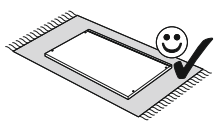
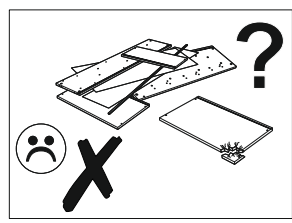
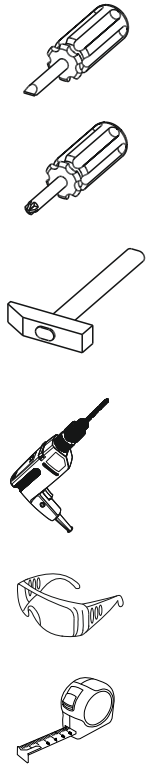
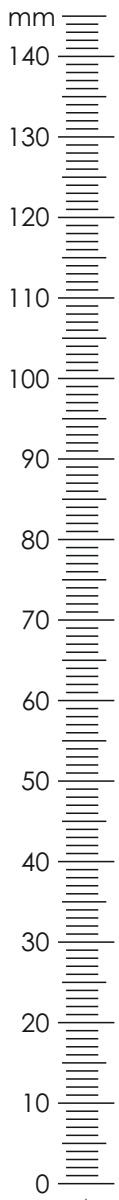
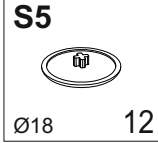
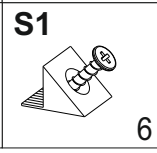
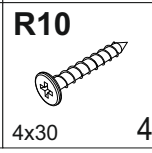
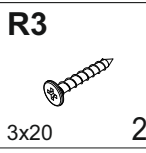
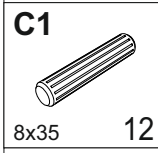
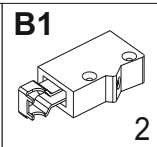
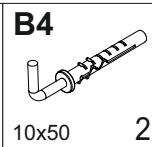
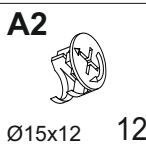
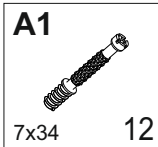
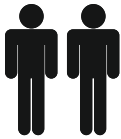

1

A1

7x34

12

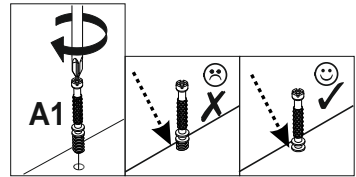
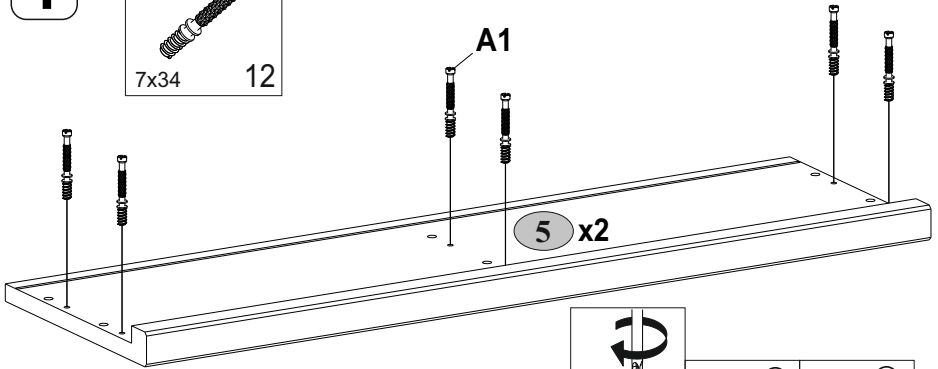

2

C1

8x35

12

B1

2

R10

4x30

4

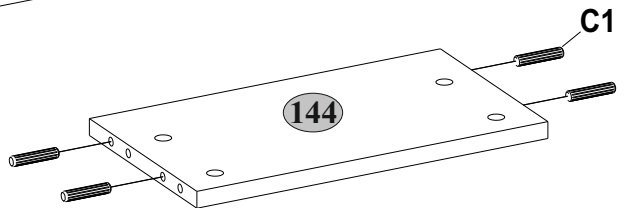
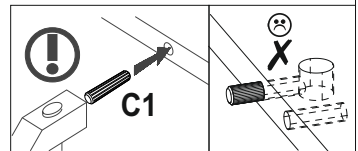
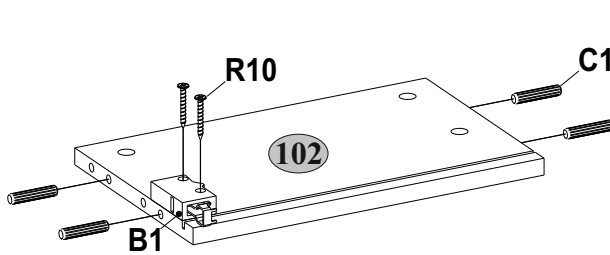
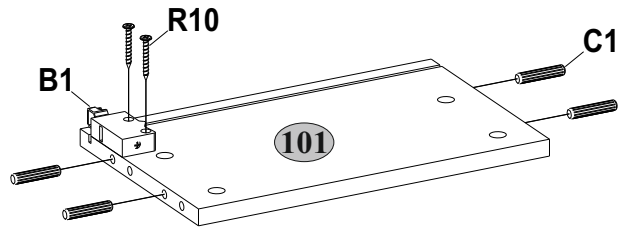

3

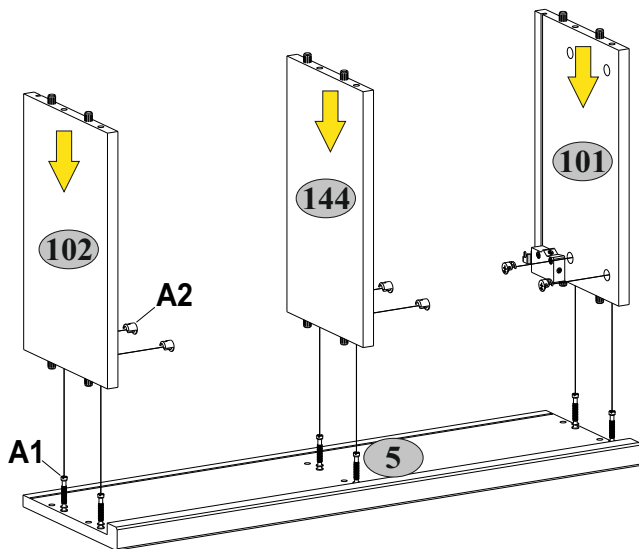
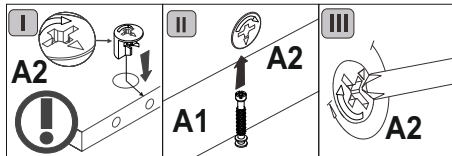
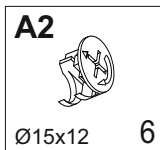

4

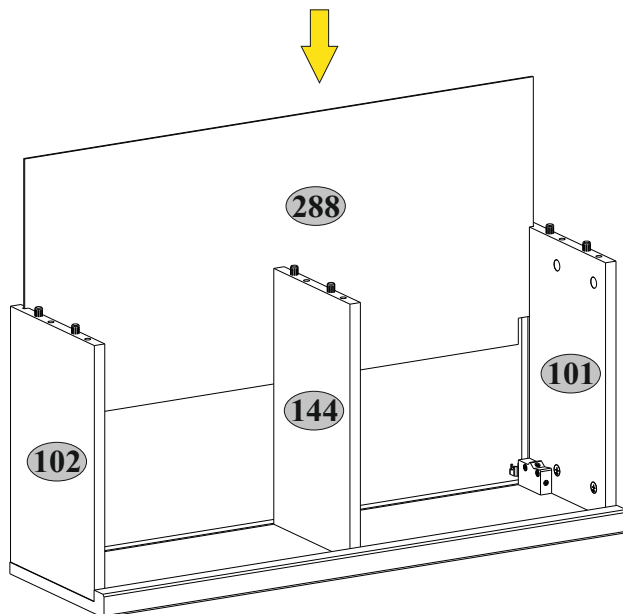

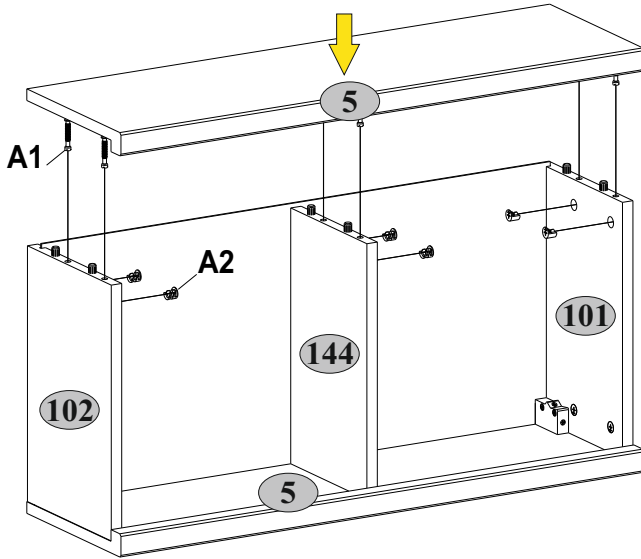
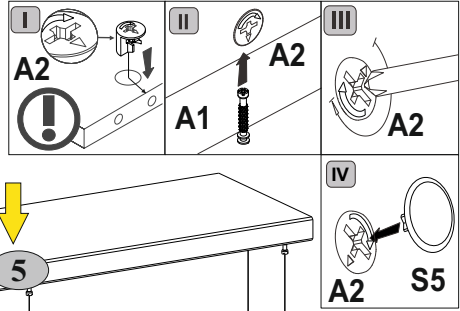
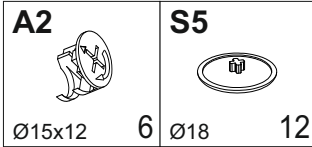
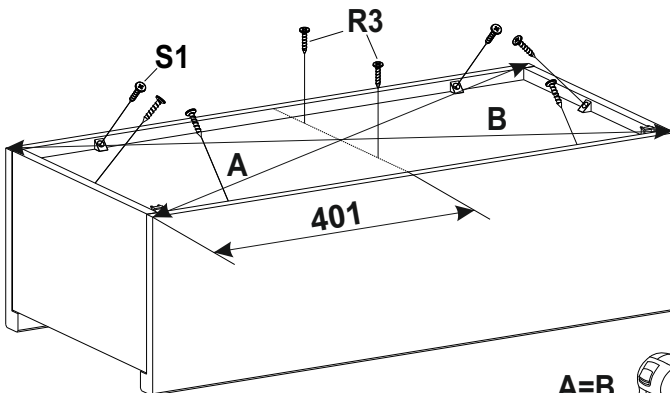
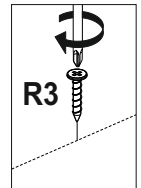
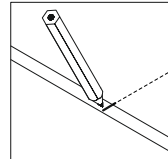
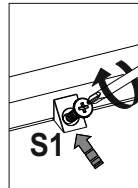
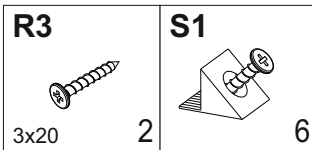
**5****6**

A=B

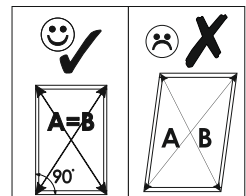
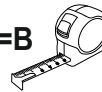

7

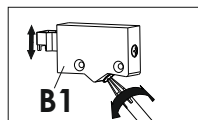
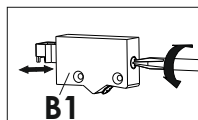
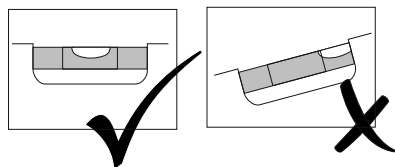
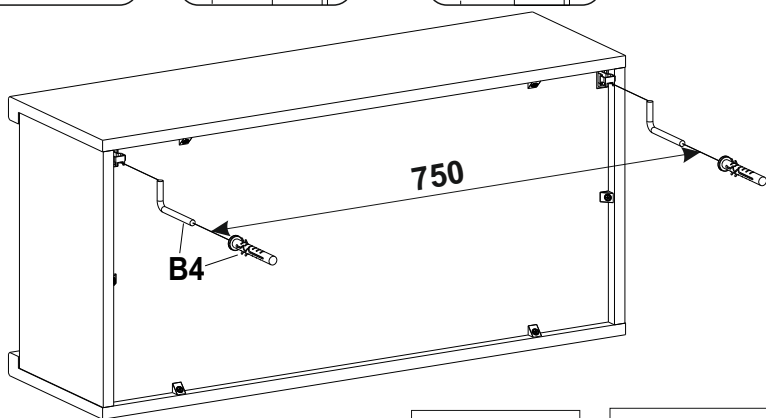
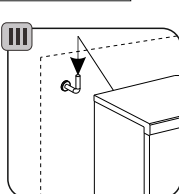
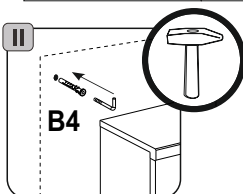
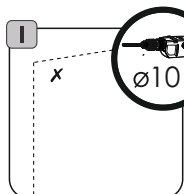
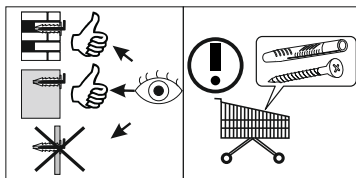
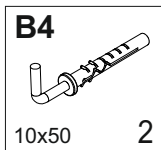

5 max. 10 kg

