

Instrukcja montażu mebli «DOORSET»

Komoda 2D

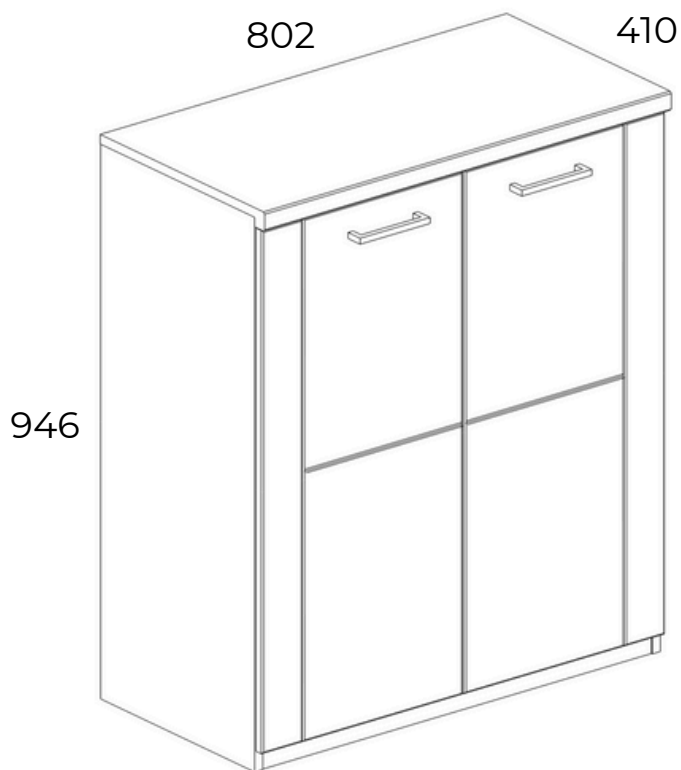







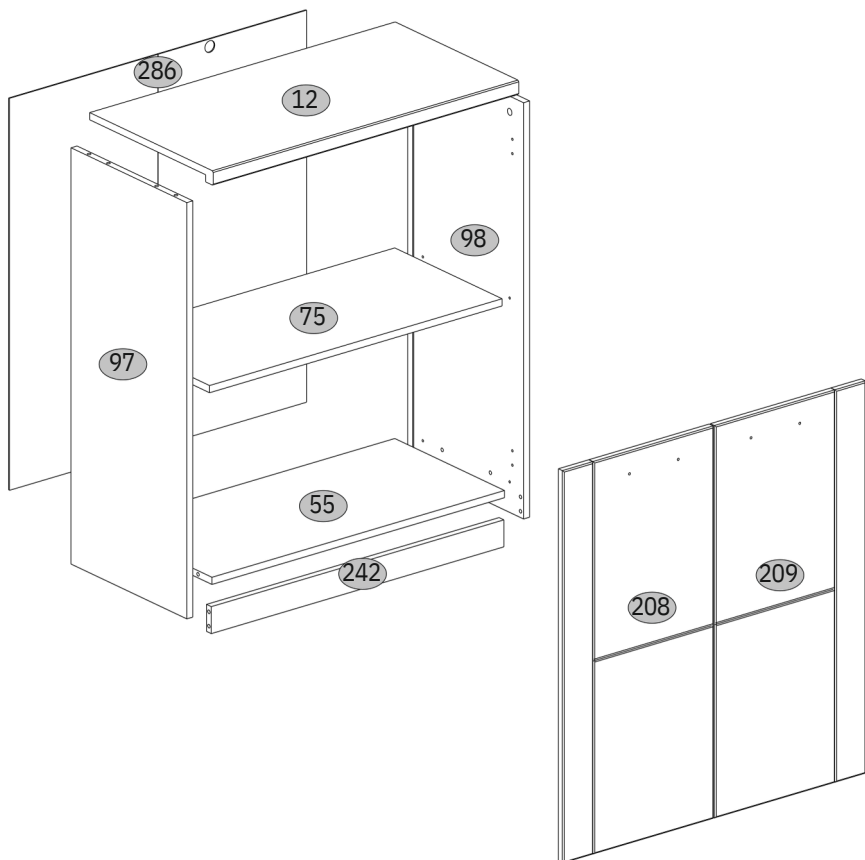

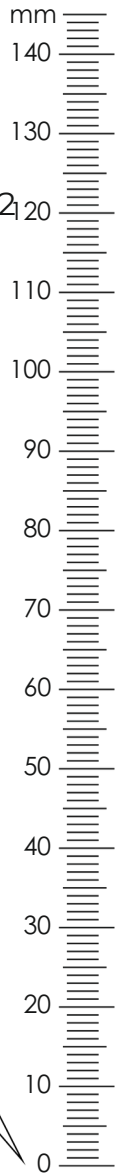

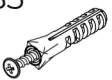
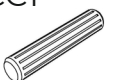
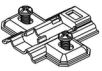
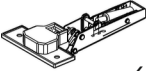

Production date
Data produkcji

Stamp of Quality Department
Pieczęć Działu Jakości

№	L, mm	B, mm	H, mm	Q	№ pack
12	802	410	32	1	1/1
55	768	364	16	1	1/1
75	768	356	16	1	1/1
97	926	384	16	1	1/1
98	926	384	16	1	1/1
208	873	396	16	1	1/1
209	873	396	16	1	1/1
242	768	60	16	1	1/1
286	872	780	2,5	1	1/1



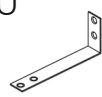

A1  7x34 8	A2  Ø15x12 8	B5  10x50 8	CC1  8x35 4
D1-1  4	E1-1  4	H58  2	N1  4
P5  4	R3  3x20 4	R23  6,3x13 4	R32  4x27 8
R102  3,5x16 10	S1  8	S5  Ø18 8	U  130x35x15 1

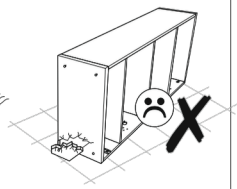
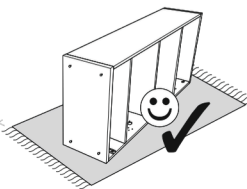
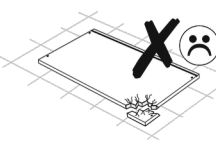
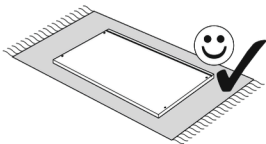
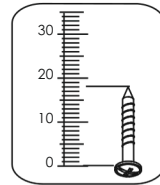
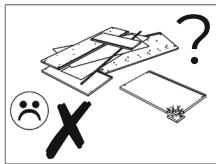
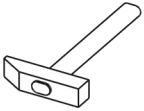
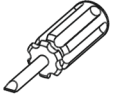

1

A1 7x34 4	CC1 8x35 4	D1-1 404 4	P5 4	R23 6,3x13 8
N1 4				

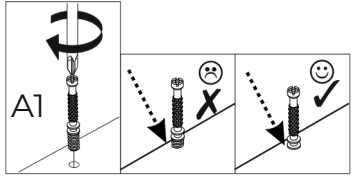
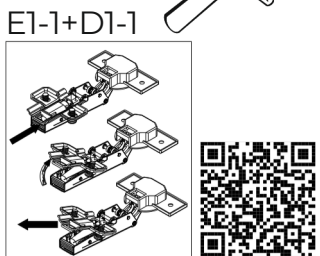
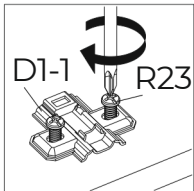
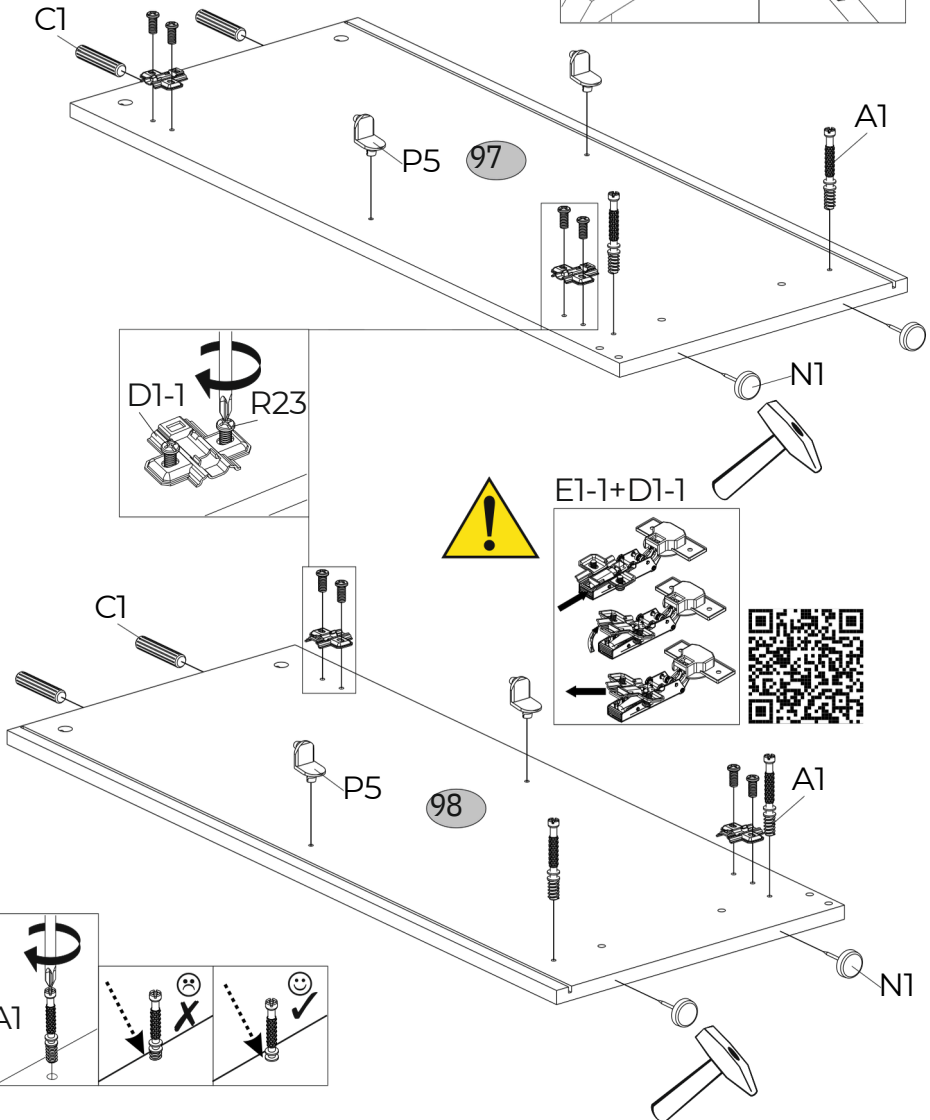

2

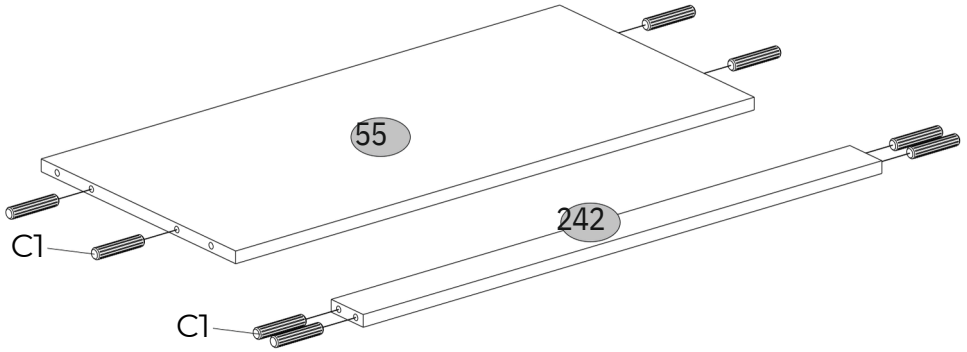
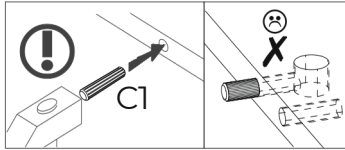
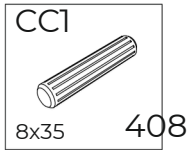

3

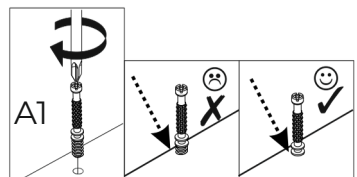
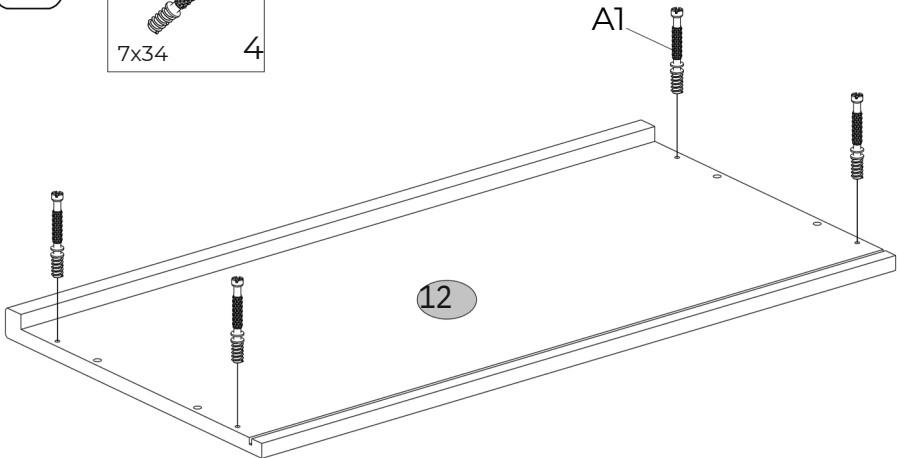
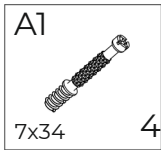

4

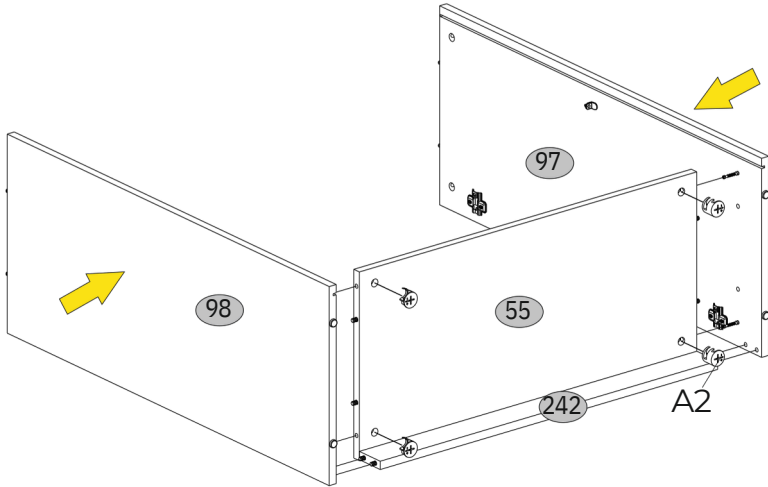
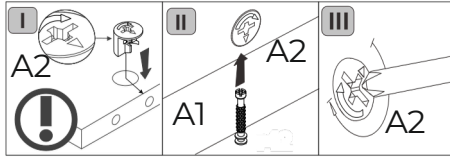
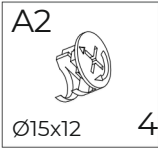

5

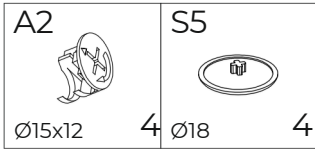

A2

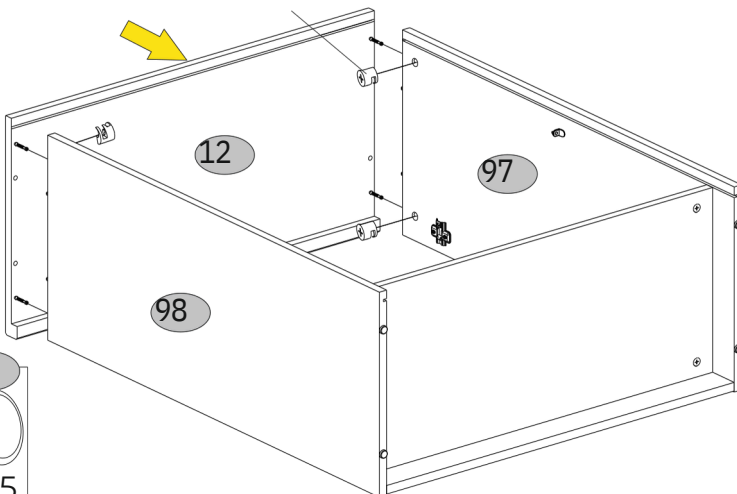
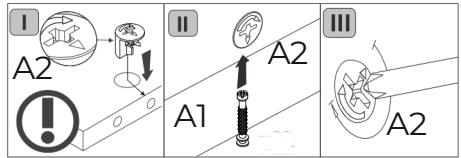

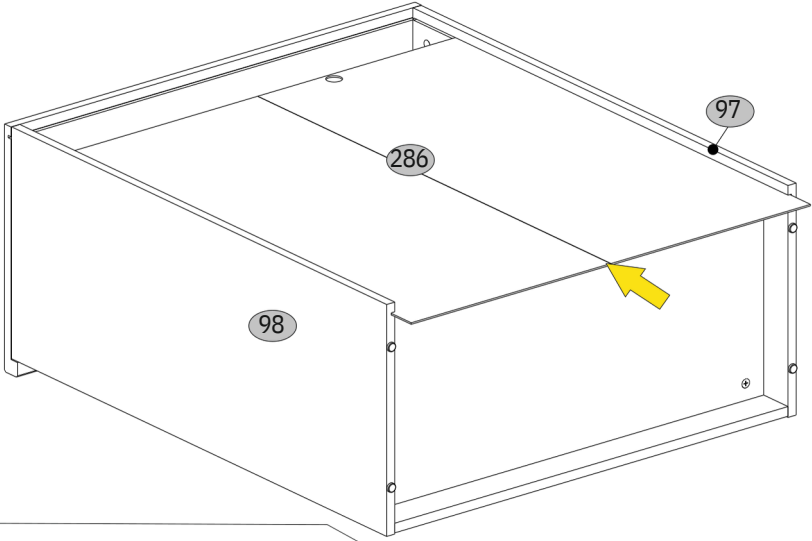

6

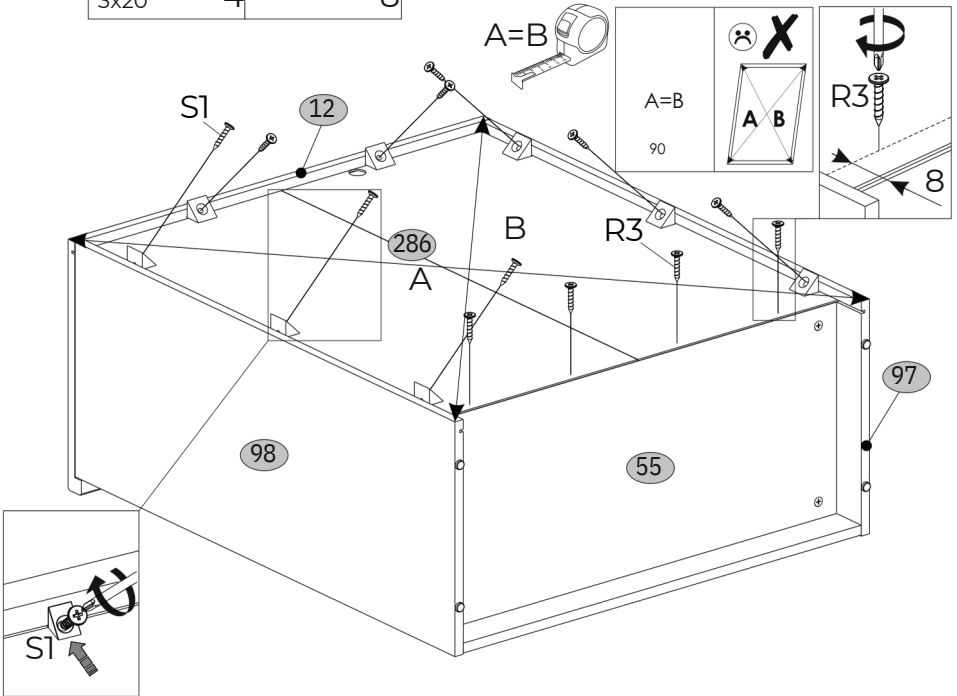
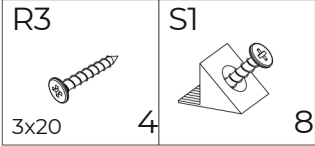

7





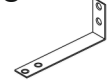

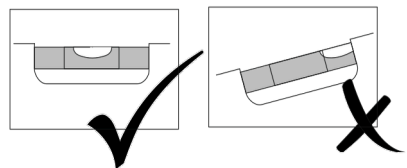
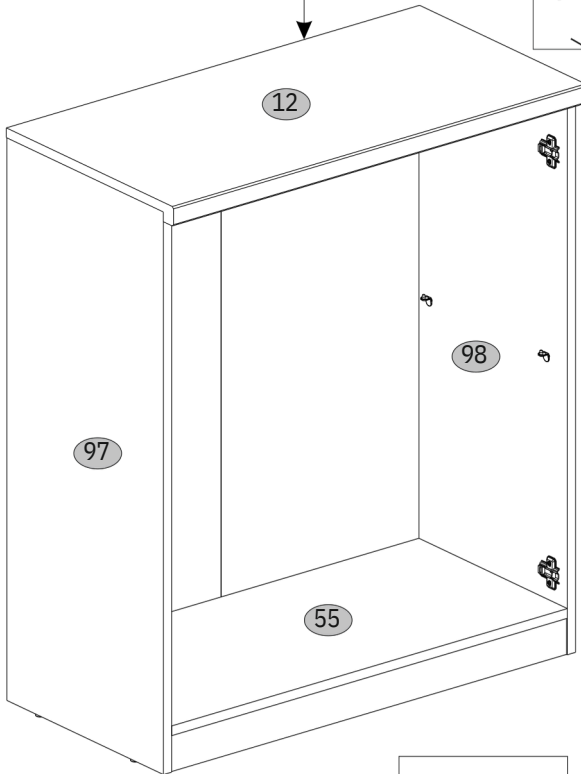
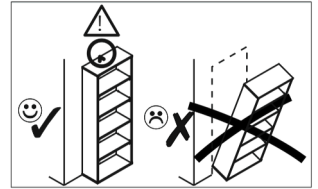
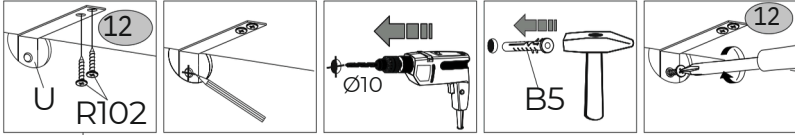
8

B5  10x50	1	R102  3,5x16	2	U  130x35x15	1
--------------------------------------------------------------------------------------------------	---	-----------------------------------------------------------------------------------------------------	---	-----------------------------------------------------------------------------------------------------	---

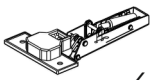

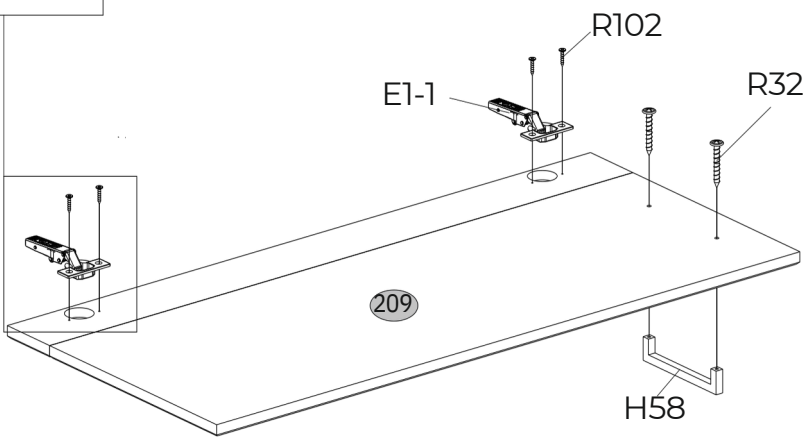
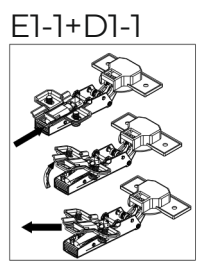
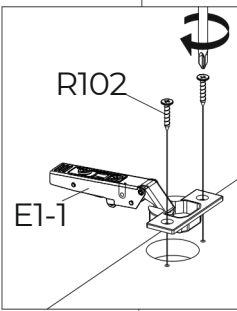
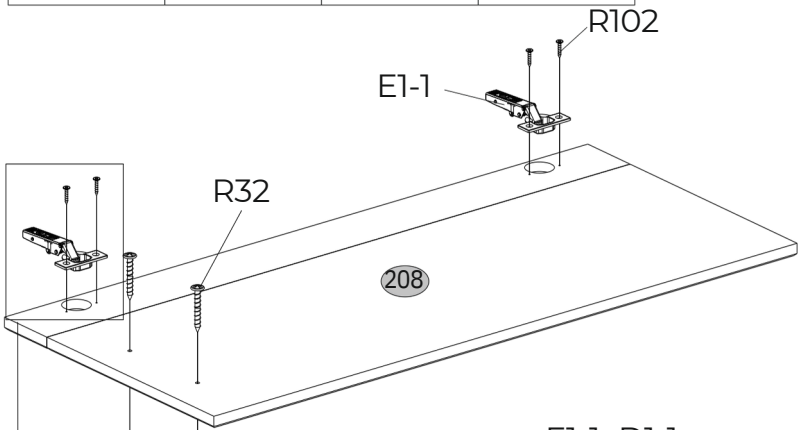

9

E1-1	H58	R32	R102
			
4	2	4x27	4 3,5x16 8

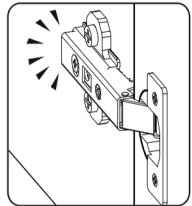
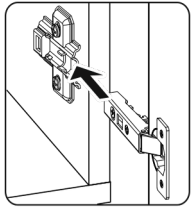
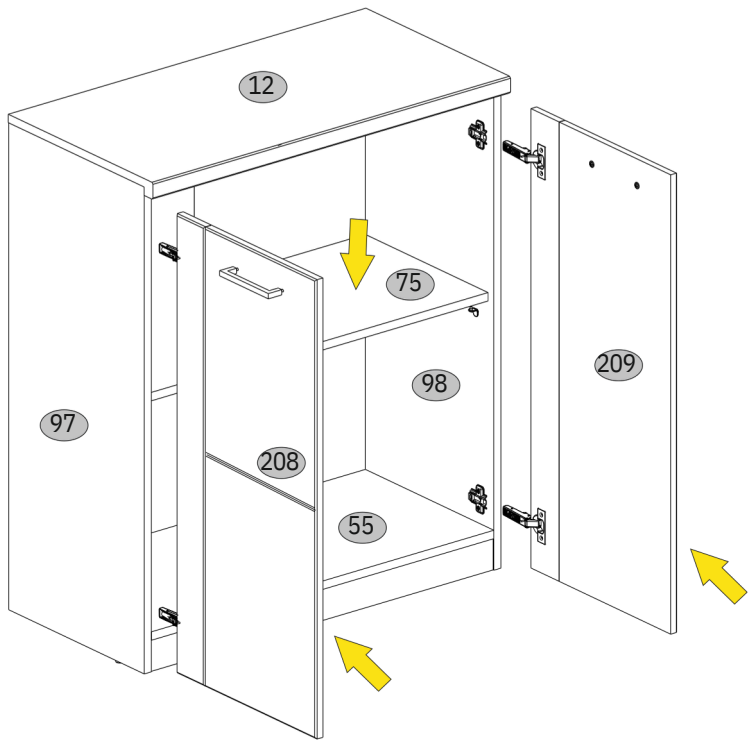

10



12 55 75  max. 5 kg

