

Instrukcja montażu mebli

«DOORSET»

Komoda 2d4s

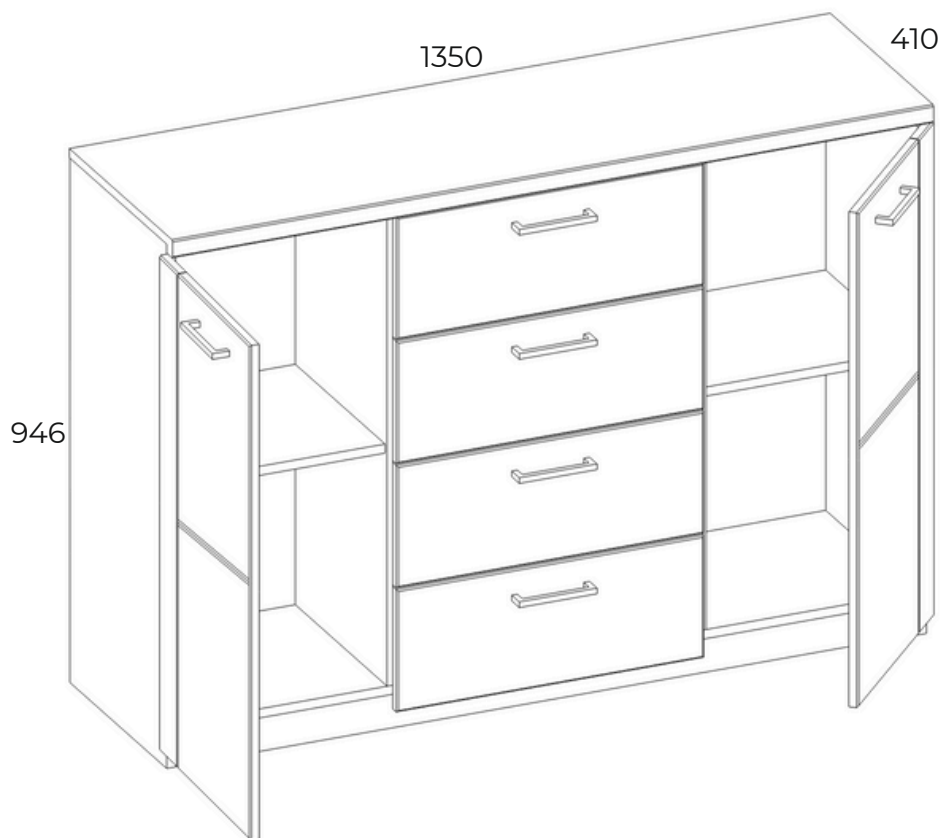





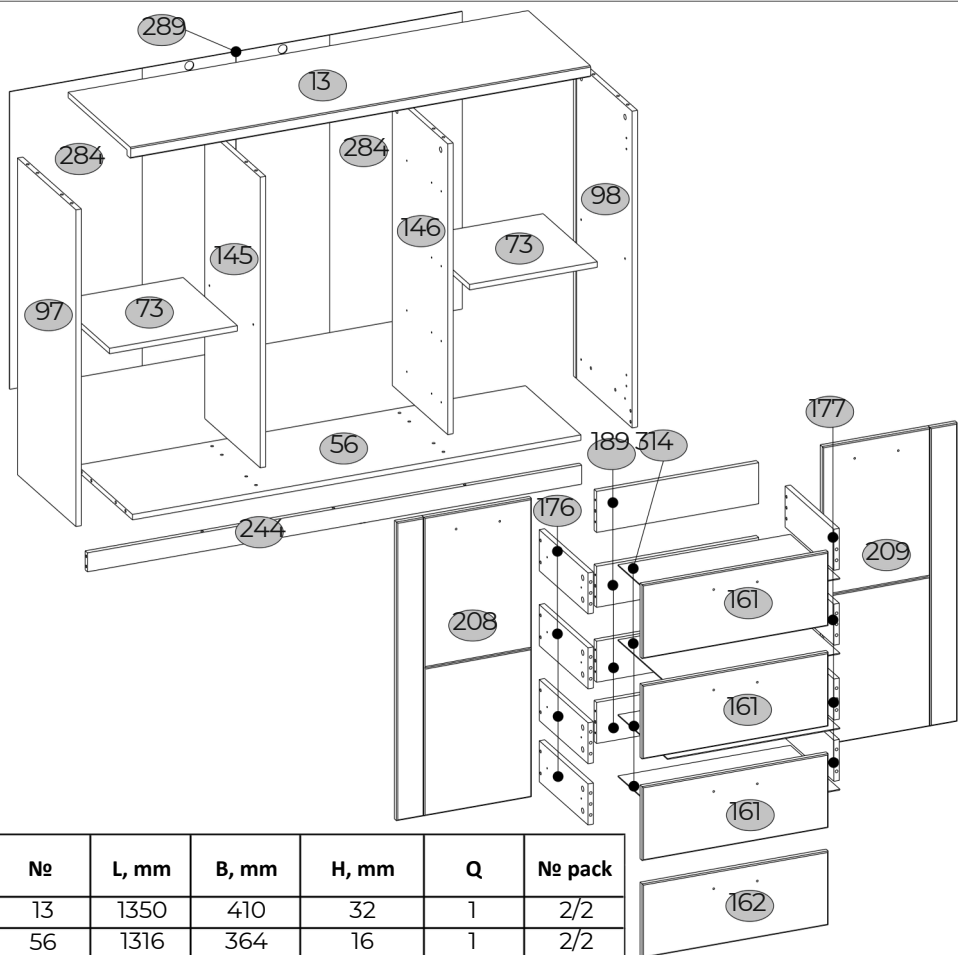

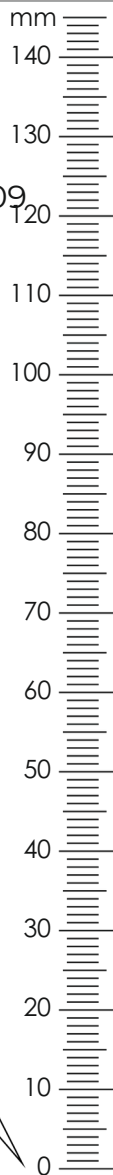



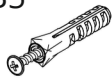
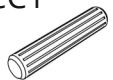
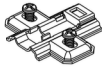
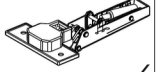



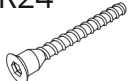

Production date
Data produkcji

Stamp of Quality Department
Pieczęć Działu Jakości



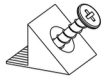
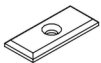

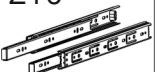

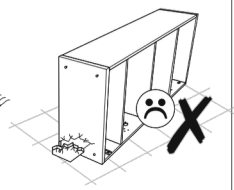
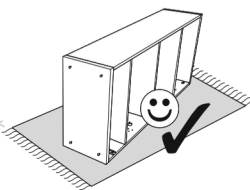
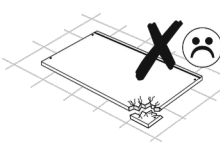
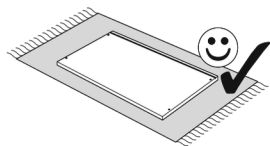
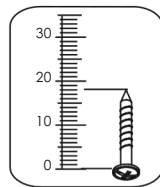
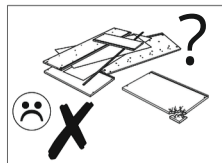
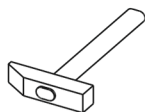
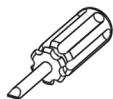

A1  7x34 28	A2  Ø15x12 28	B5  10x50 2	CC1  8x35 4309
D1-1  4	E1-1  4	I  S4 1	H58  6
L1  320 4	N1  6	P5  8	R3  3x20 56
R23  6,3x13 8	R24  7x50 20	R27  5,0x13 40	R32  4x27 12
R102  3,5x16 20	S1  8	S3  8	S5  Ø18 20
U  130x35x15 2	Z10  300 4		

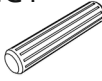

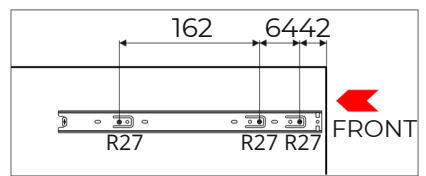
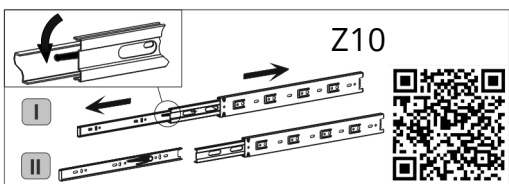
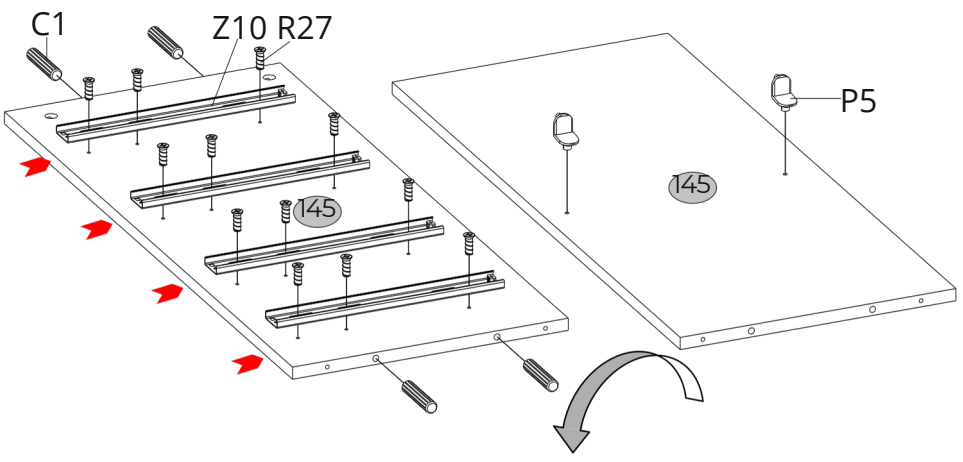
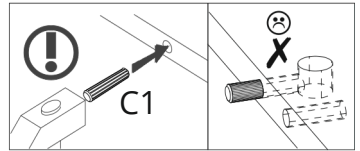
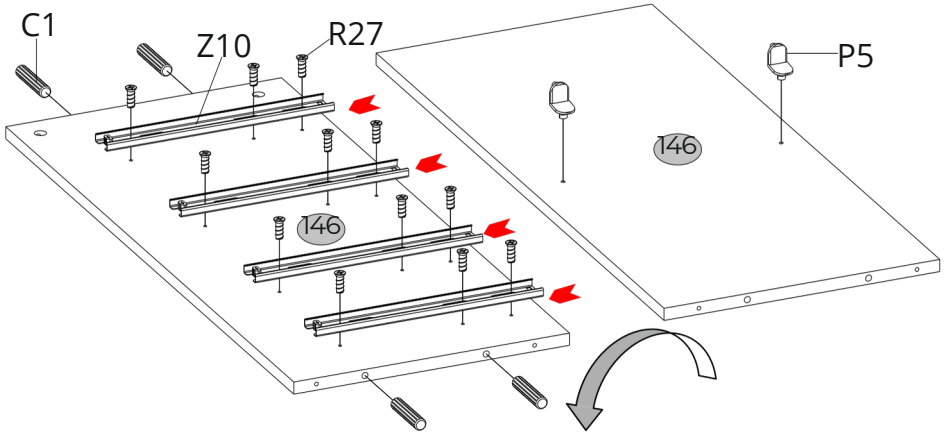

1

CC1  8x35	P5  408	R27  4 5,0x13	Z10  24 300 4
--	--	--	--

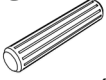

2

CC1	N1
	
8x35	4/101 2

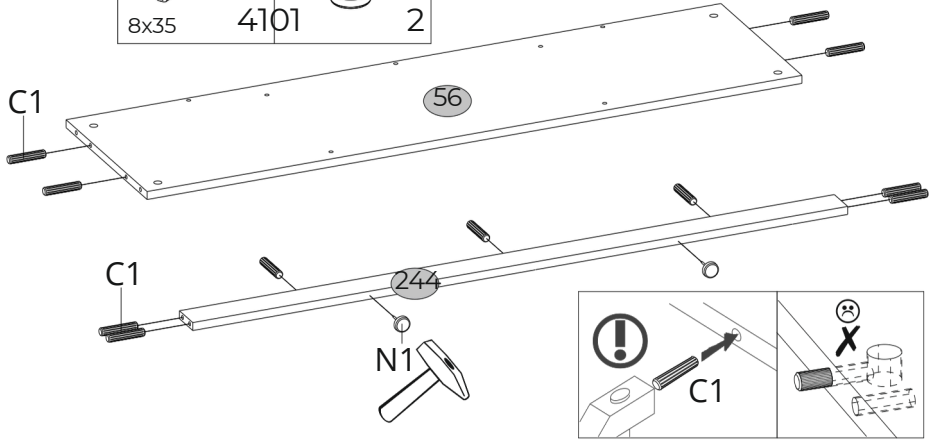

3

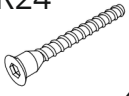
I	R24
	
S4	1 7x50 4

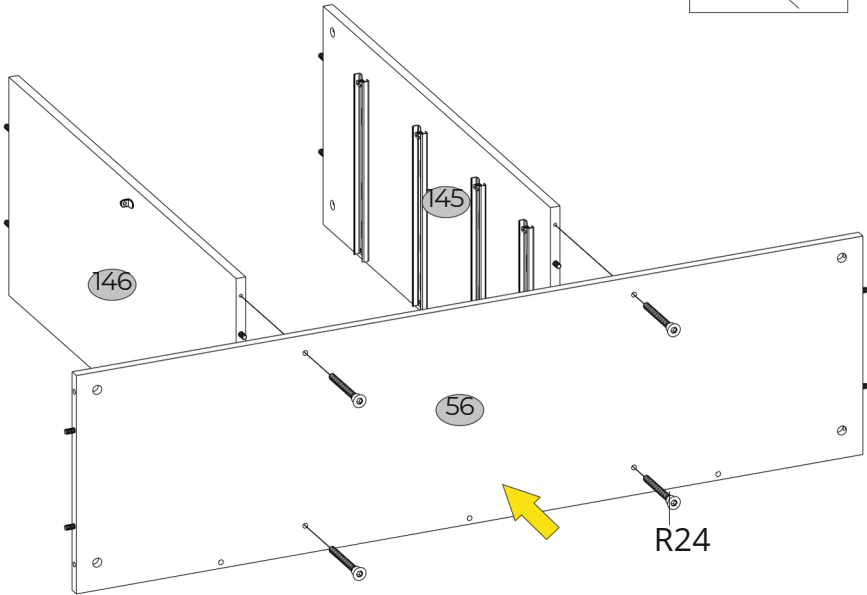
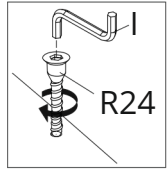

4

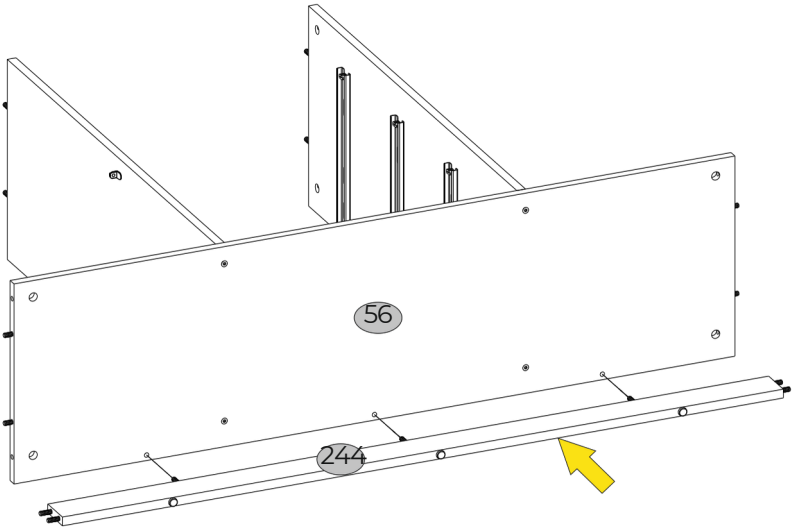

5

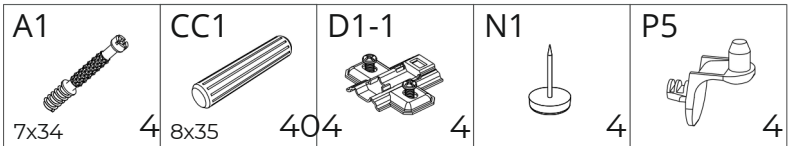

E1-1+D1-1

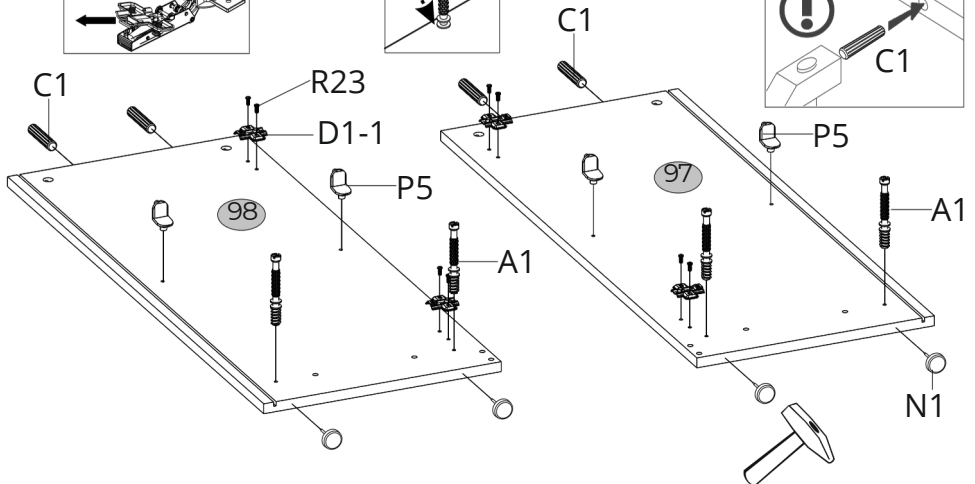
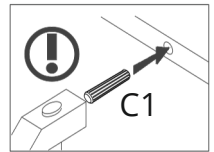
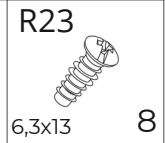
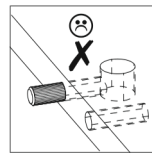
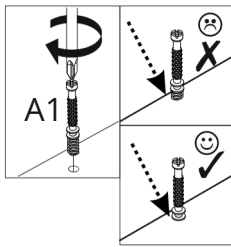
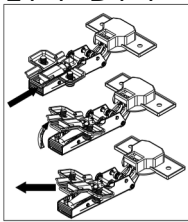

6

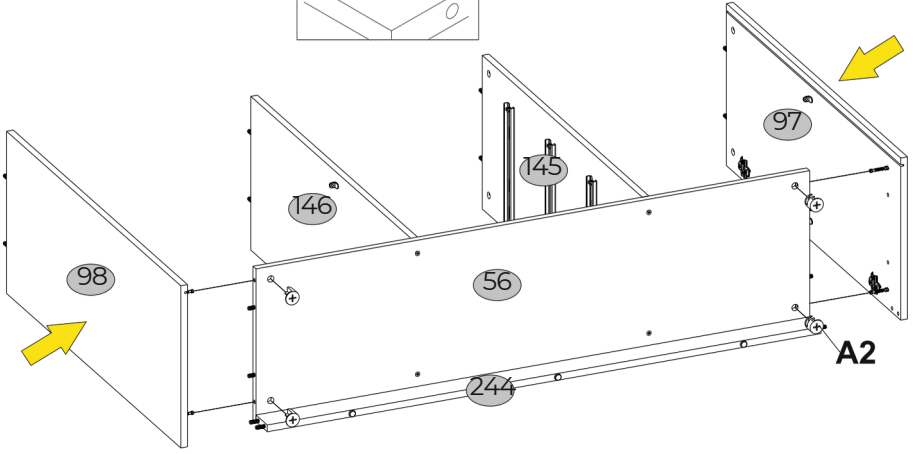
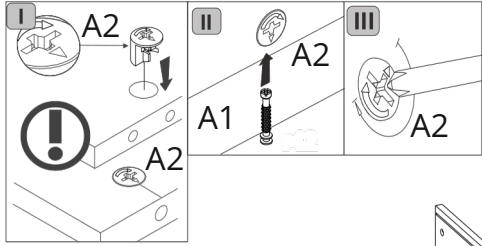
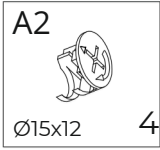

7

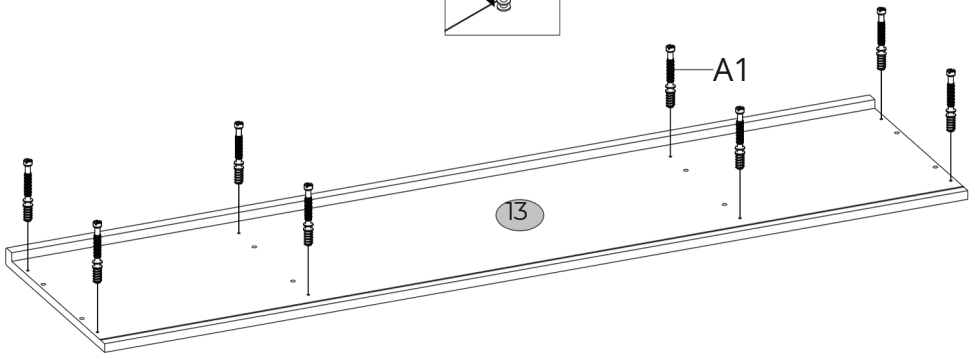
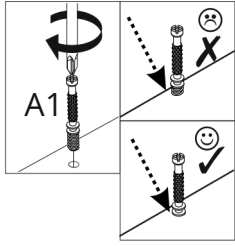
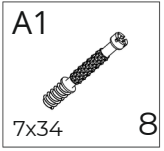

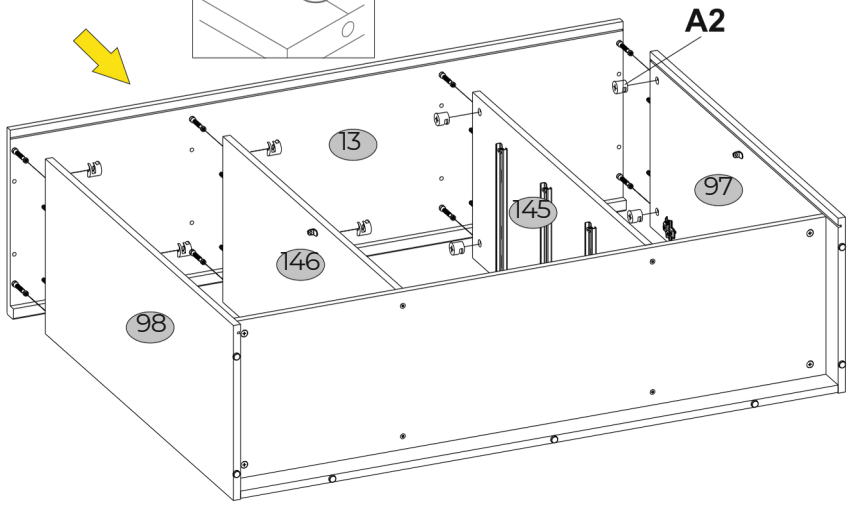
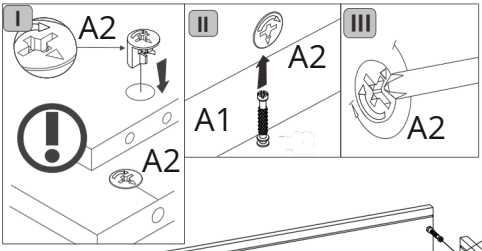
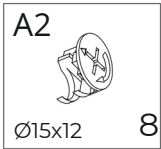

8

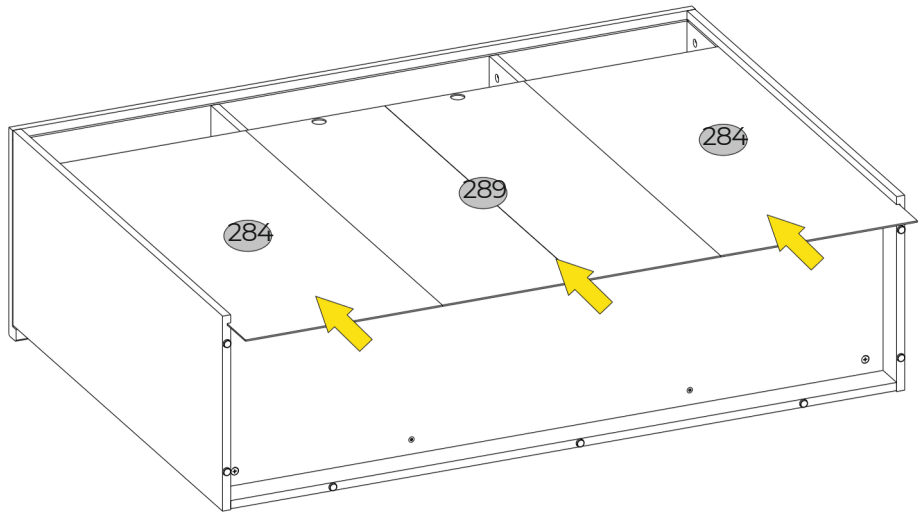

9







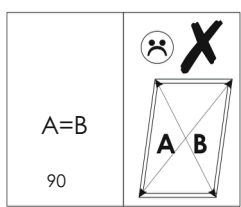
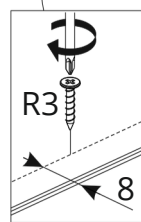
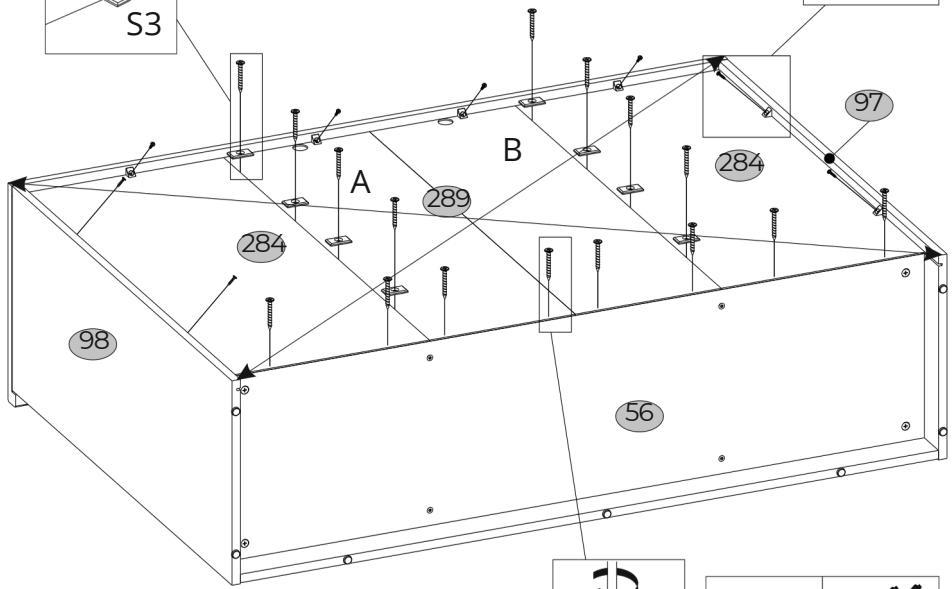
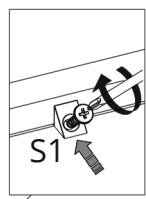
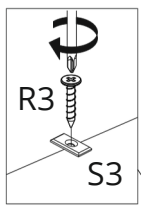

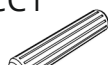

10

R3  3x20 16	S1  8	S3  8
---	--	--

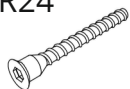

11
x4

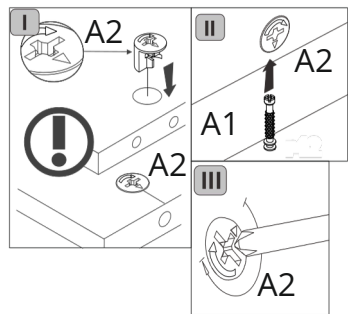
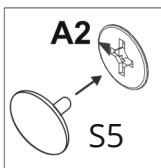
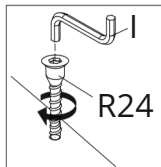
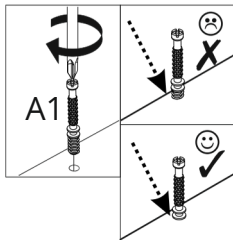
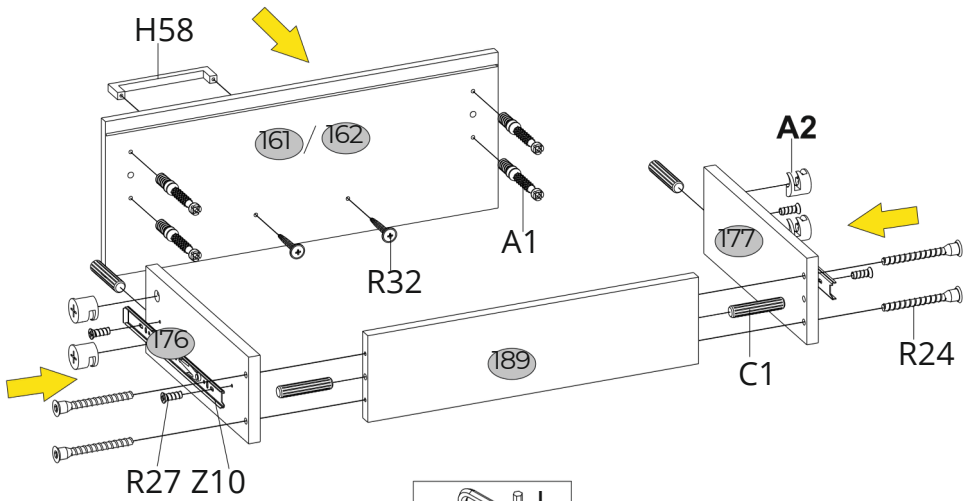
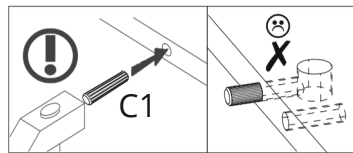
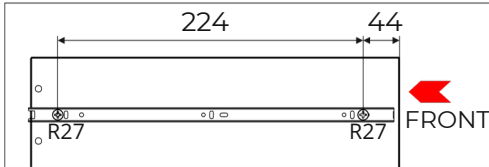

<p>A1</p>  <p>7x34 16</p>	<p>A2</p>  <p>Ø15x12 16</p>	<p>CC1</p>  <p>8x35 4</p>	<p>I</p>  <p>1</p>	<p>H58</p>  <p>4</p>
<p>R24</p>  <p>7x50 16</p>	<p>R27</p>  <p>5,0x13 16</p>	<p>R32</p>  <p>4x27 8</p>	<p>S5</p>  <p>Ø18 16</p>	<p>Z10</p>  <p>300 4</p>

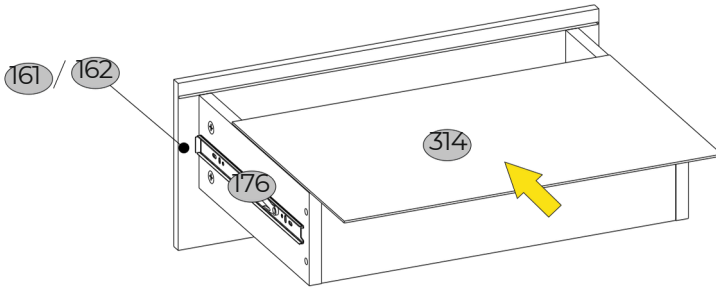

12
x4



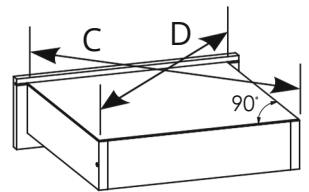
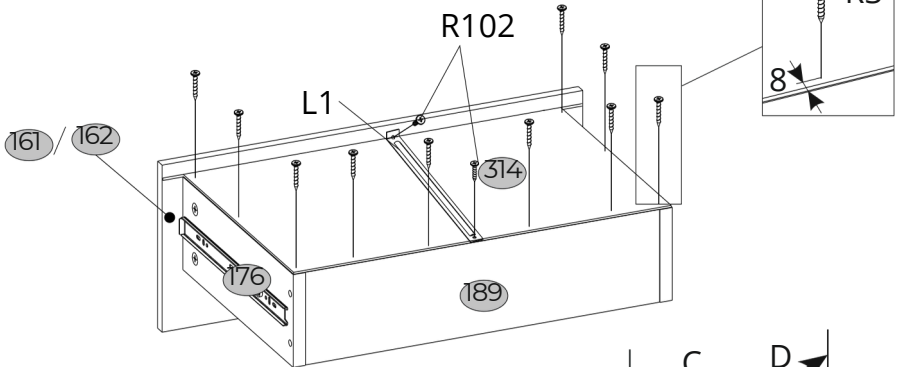

13
x4

L1	R3	R102
		
320	4 3x20	40 3,5x16 8



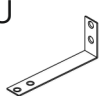

14

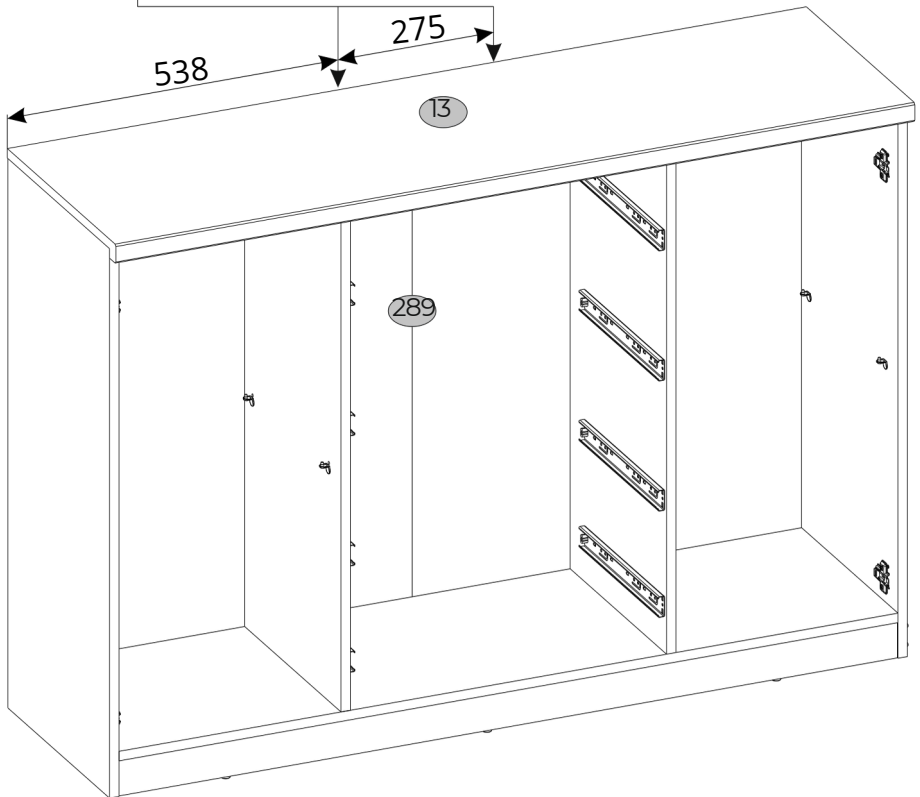
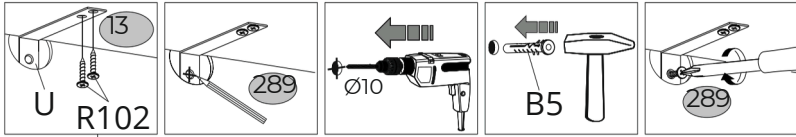
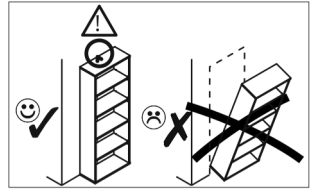
B5  10x50	R102  3,5x16	U  130x35x15	2	4	2
---	--	--	---	---	---

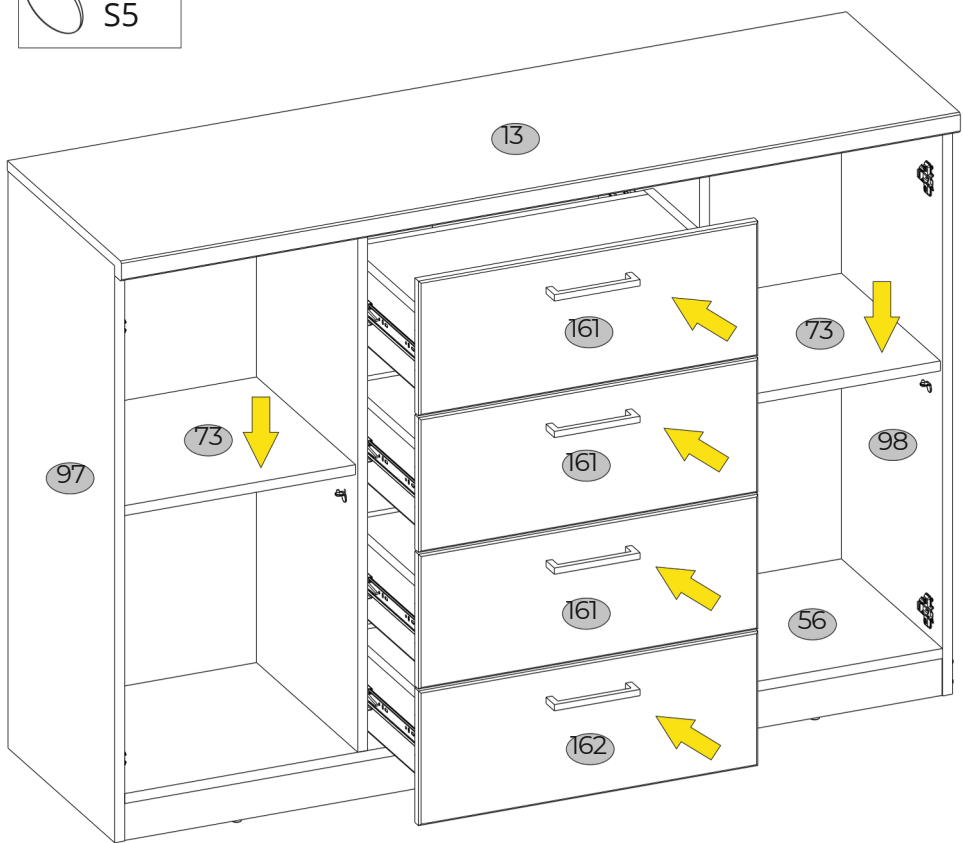
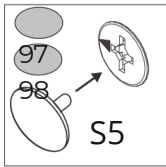
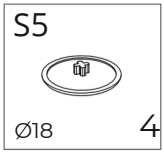

15



- 73 161 162  max. 5 kg
- 13 56  max. 10 kg

16

E1-1

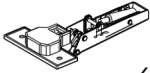

4

H58



2

R32



4x27

4

R102



3,5x16

8

R102

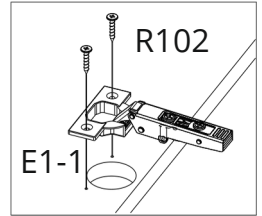

R102

E1-1

R102

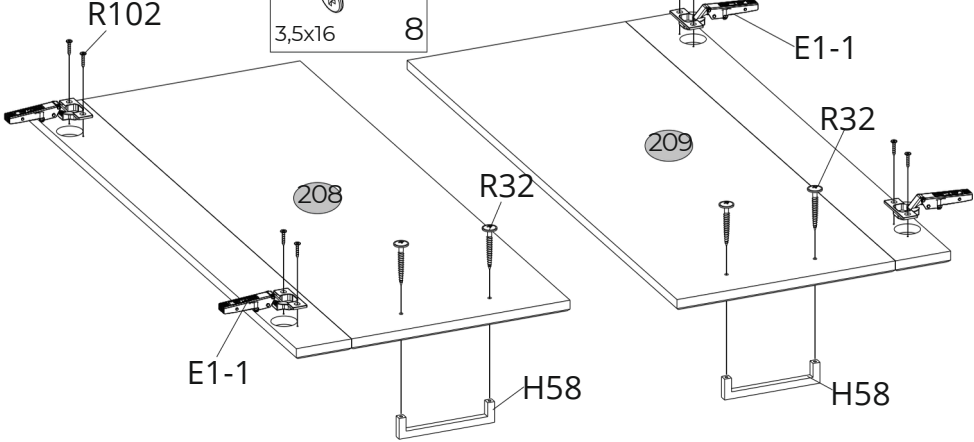

17

