

Instrukcja montażu mebli

«DOORSET»

Komoda 4d1s

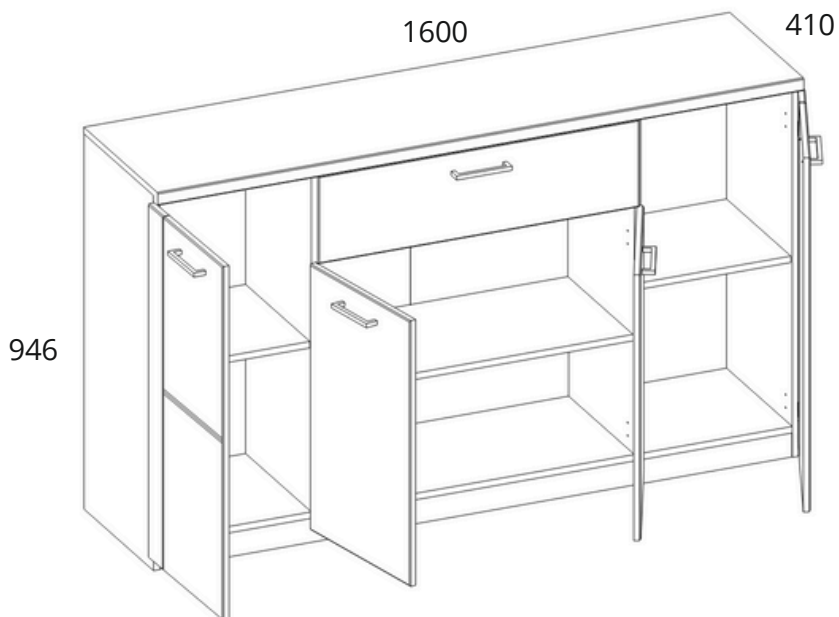

Production date
Data produkcji

Stamp of Quality Department
Pieczęć Działu Jakości

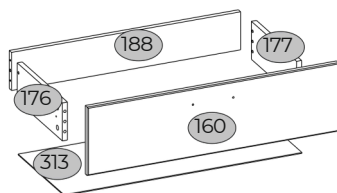
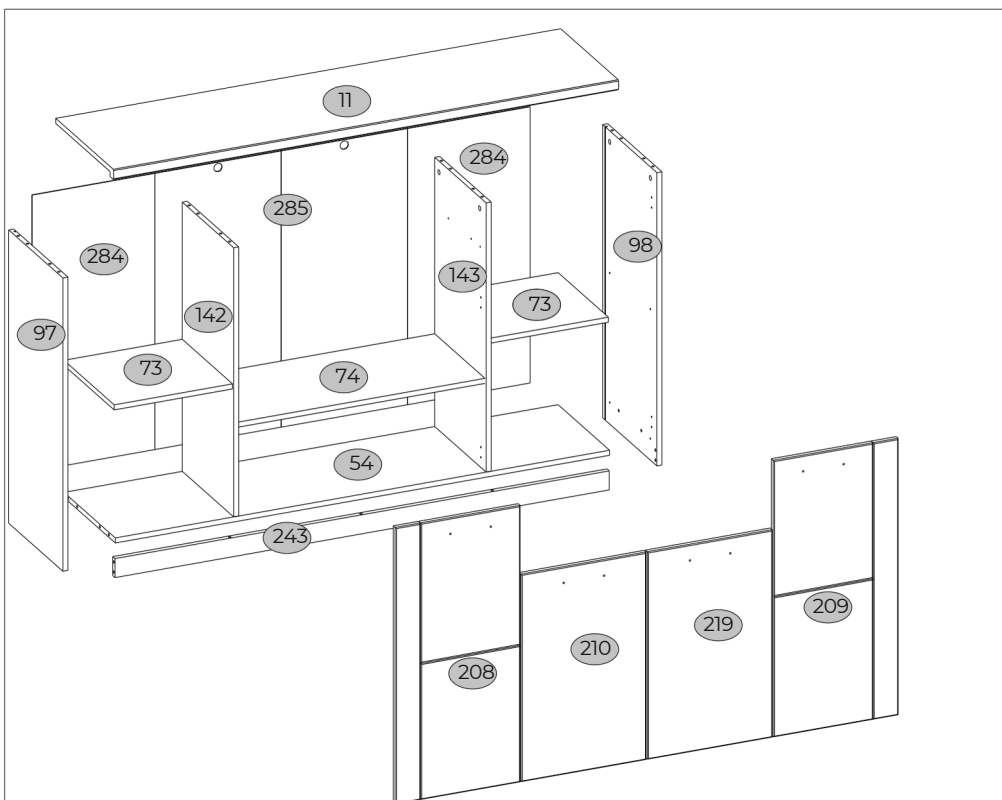



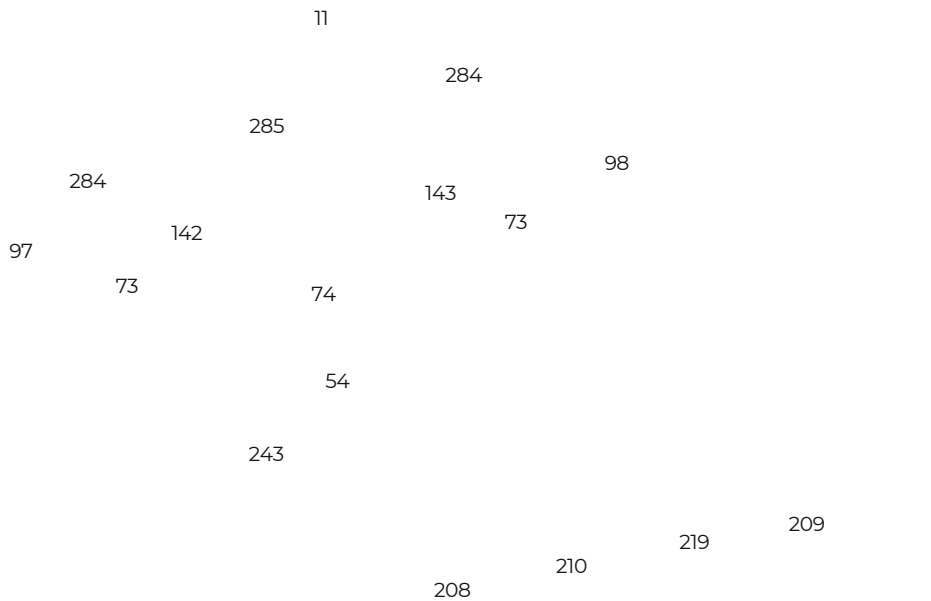



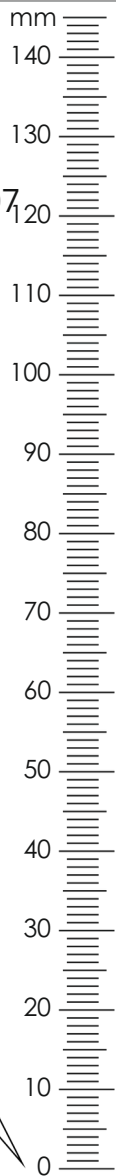





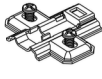
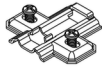
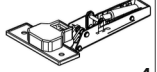
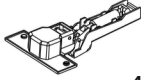





№	L, mm	B, mm	H, mm	Q	№ pack
11	1600	410	32	1	2/2
54	1566	364	16	1	2/2
73	375	356	16	2	2/2
74	784	356	16	1	2/2
97	926	384	16	1	1/2
98	926	384	16	1	1/2
142	850	364	16	1	1/2
143	850	364	16	1	1/2
160	796	216	16	1	2/2
176	320	120	16	1	2/2
177	320	120	16	1	2/2
188	726	120	16	1	2/2
208	873	396	16	1	1/2
209	873	396	16	1	1/2
210	396	655	16	1	1/2
219	396	655	16	1	1/2
243	1566	60	16	1	2/2
284	872	389	2,5	2	2/2
285	872	800	2,5	1	2/2
313	756	325	16	1	2/2

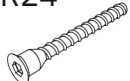

№	L, mm	B, mm	H, mm	Q	№ pack	188	177
11	1600	410	32	1	2/2	176	
54	1566	364	16	1	2/2		160
73	375	356	16	2	2/2	313	
74	784	356	16	1	2/2		
97	926	384	16	1	1/2		
98	926	384	16	1	1/2		
142	850	364	16	1	1/2		
143	850	364	16	1	1/2		
160	796	216	16	1	2/2		
176	320	120	16	1	2/2		
177	320	120	16	1	2/2		
188	726	120	16	1	2/2		
208	873	396	16	1	1/2		
209	873	396	16	1	1/2		
210	396	655	16	1	1/2		
219	396	655	16	1	1/2		
243	1566	60	16	1	2/2		
284	872	389	2,5	2	2/2		
285	872	800	2,5	1	2/2		
313	756	325	16	1	2/2		

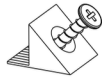
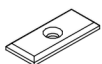

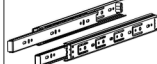
A1  7x34 16	A2  Ø15x12 16	B5  10x50 2	CC1  8x35 4207
D1-1  4	D1-3  4	E1-1  4	E4-1  4
I  S4 1	H58  5	L1  320 1	N1  7
P5  12	R3  3x20 26	R23  6,3x13 16	R24  7x50 8
R27  5,0x13 10	R32  4x27 10	R102  3,5x16 22	S1  16
S3  8	S5  Ø18 8	U  130x35x15 2	Z10  300 1

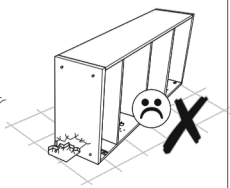
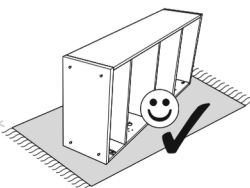
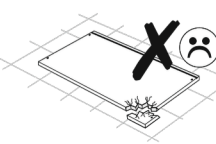
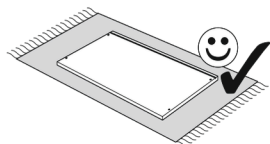
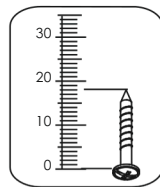
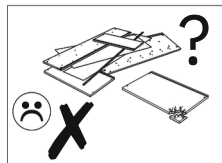
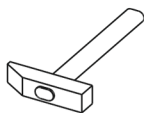
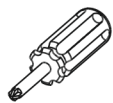
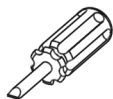

1

CC1

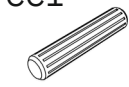

8x35

408

D1-3

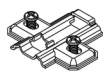

4

P5



8

R23



6,3x13

8

R27



5,0x13

6

Z10



300

1

E4-1+D1-3

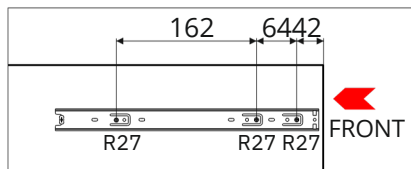
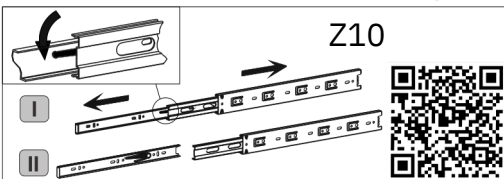
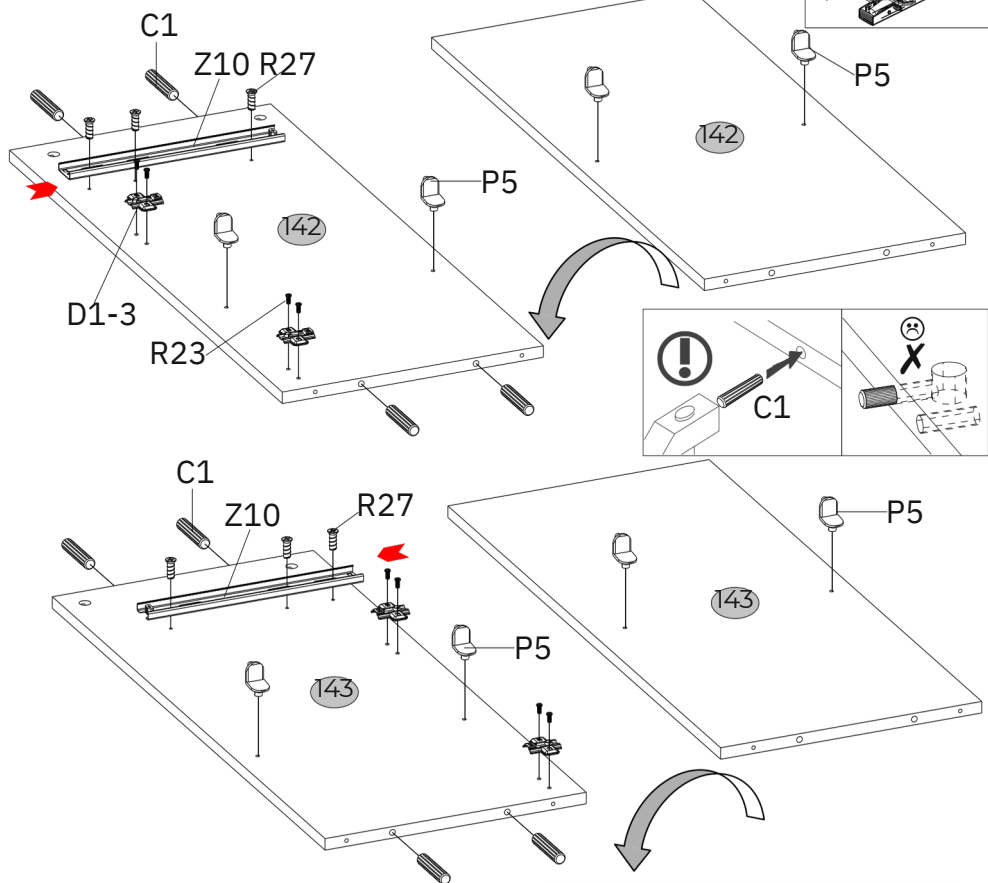
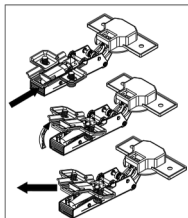

2

CC1

N1

8x35

4101

3

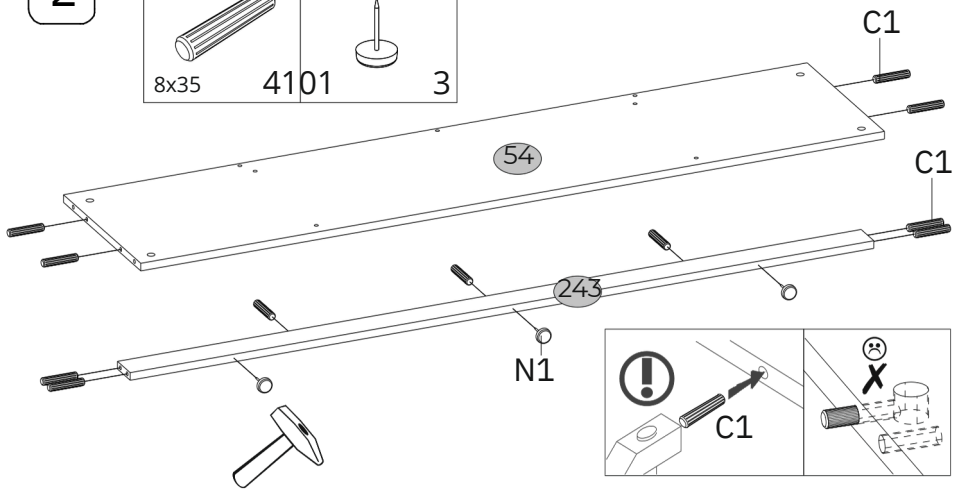

3

I

R24

S4

1

7x50

4

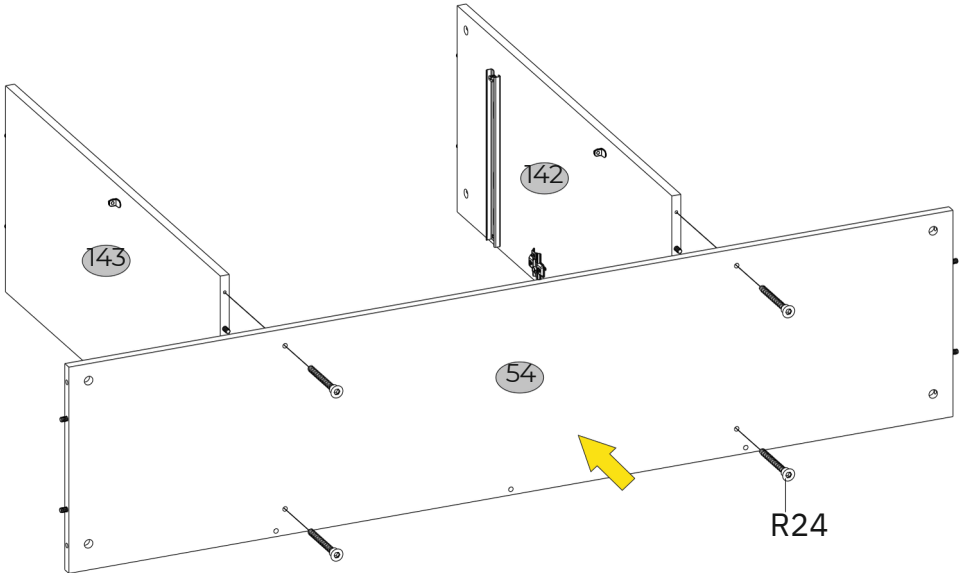
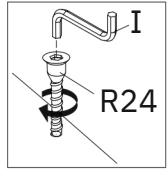

4

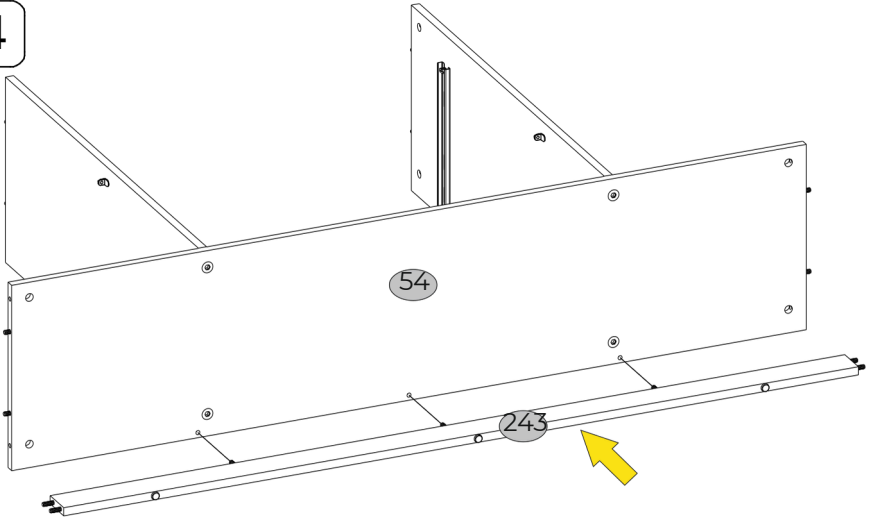

5

A1 7x34 4	CC1 8x35 404	D1-1 4	N1 4	P5 4
-----------------	--------------------	-----------	---------	---------

E1-1+D1-1

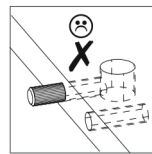
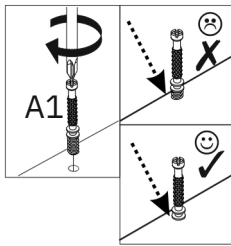
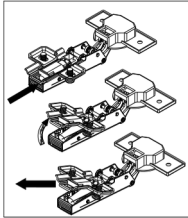

R23 6,3x13 8

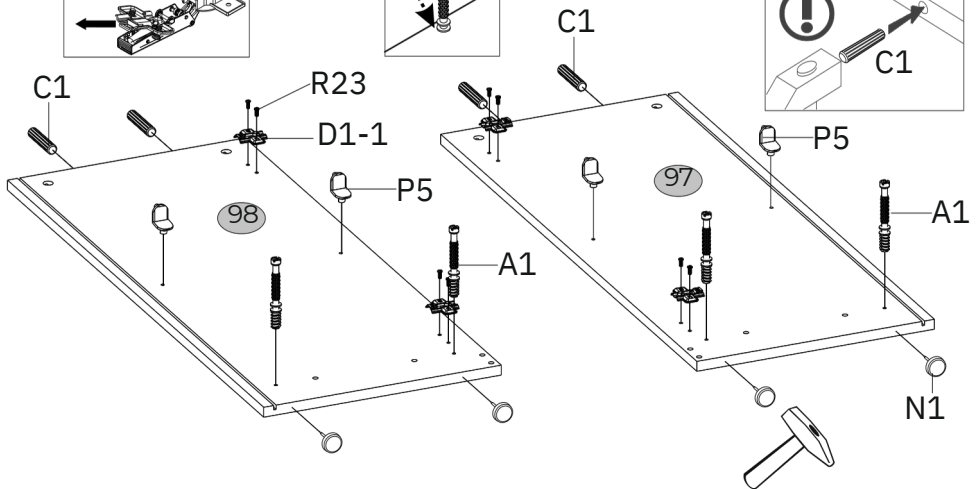
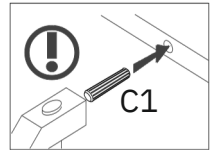

6

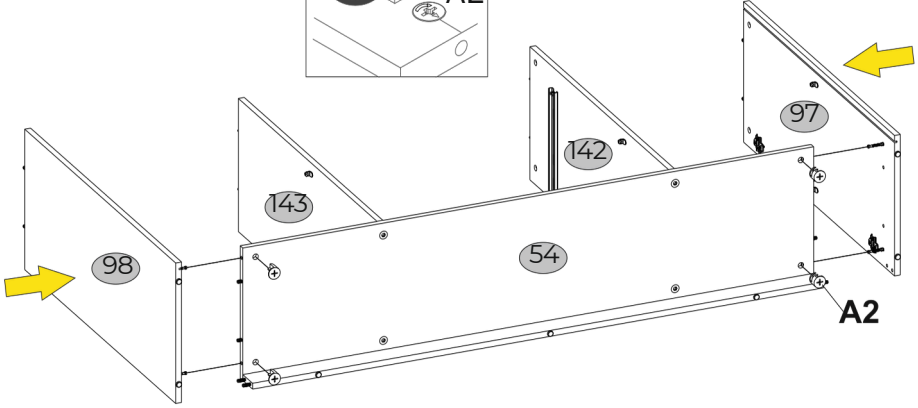
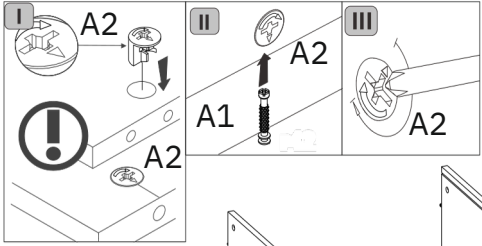
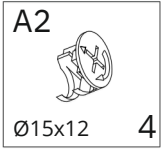

7

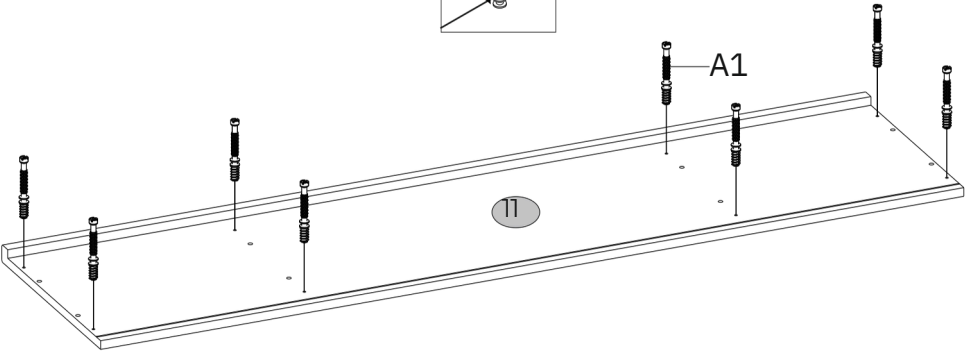
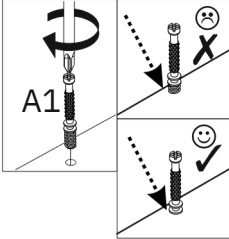
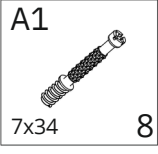

8

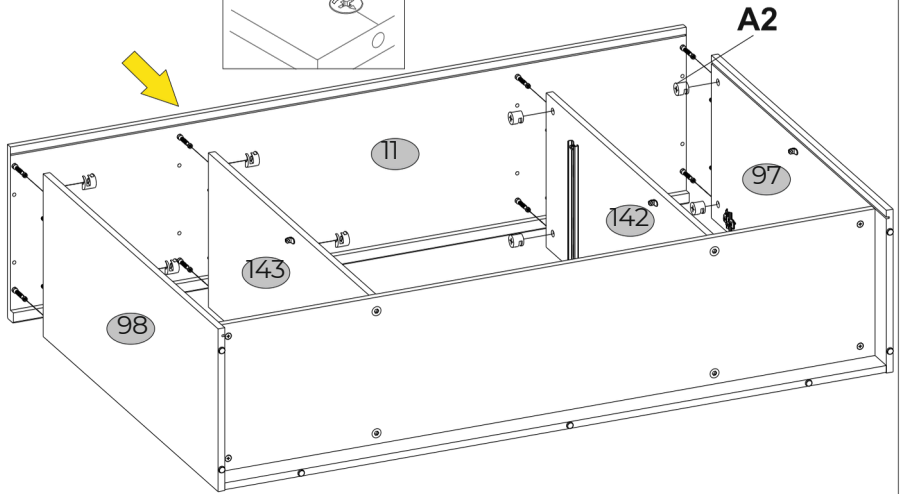
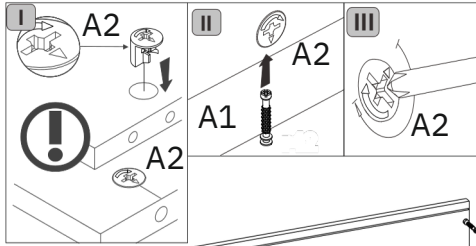
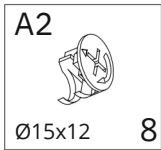

9

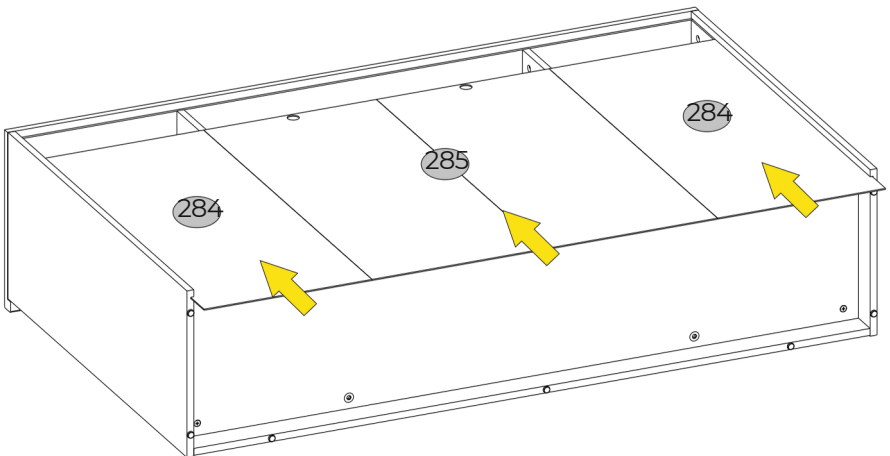





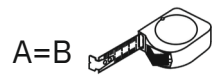
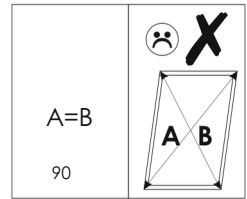
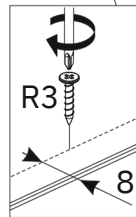
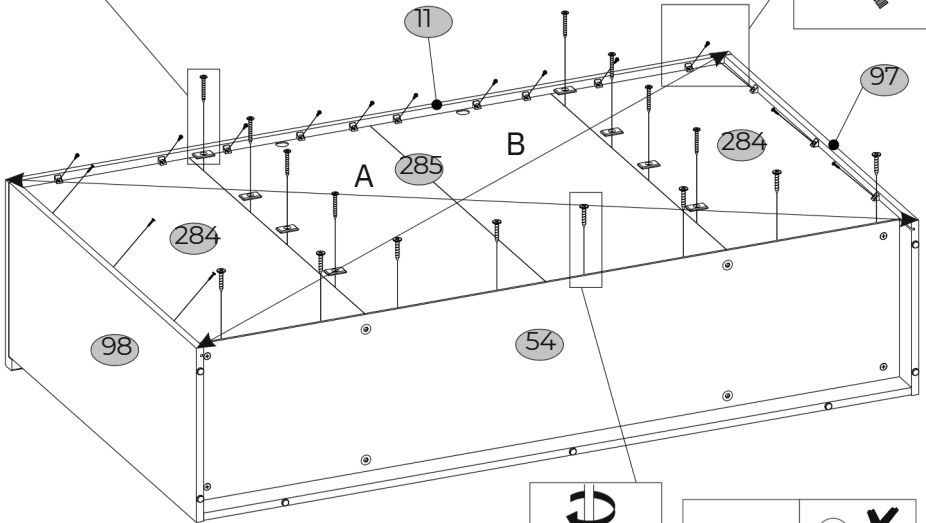
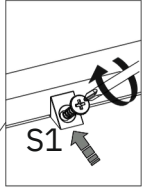
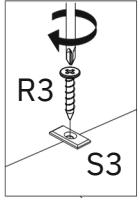

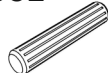

10

R3 3x20 16	S1 16	S3 8
------------------	----------	---------

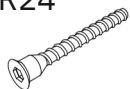

11

A1  7x34 4	A2  Ø15x12 4	CC1  8x35 4	I  40x4 1	H58  1
R24  7x50 4	R27  5,0x13 4	R32  4x27 2	S5  Ø18 4	Z10  300 1

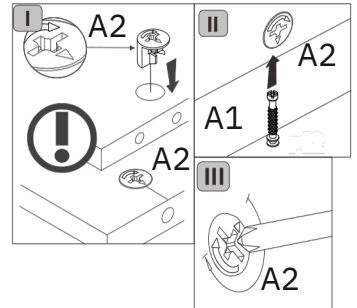
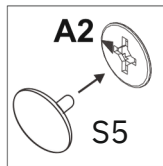
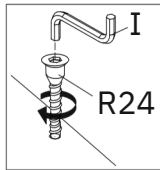
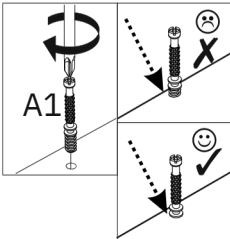
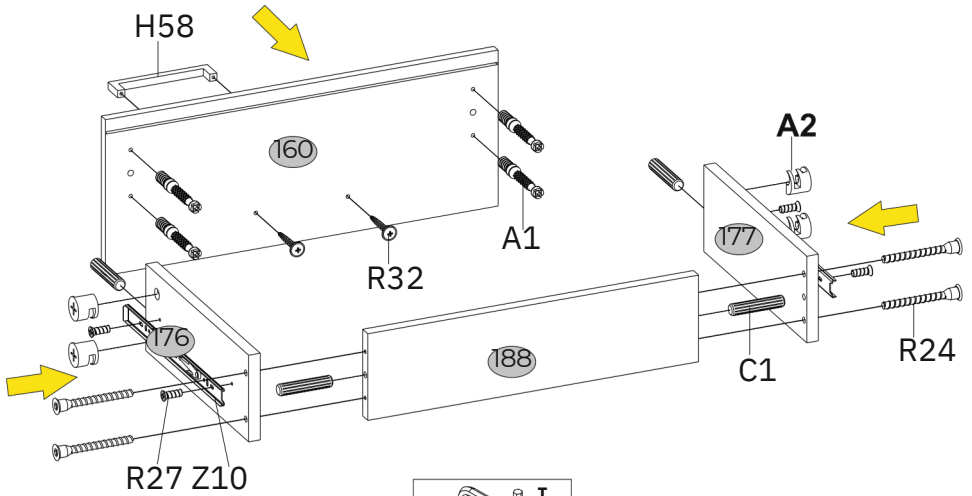
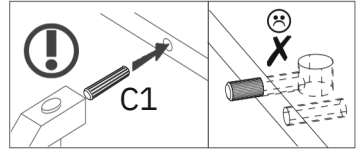
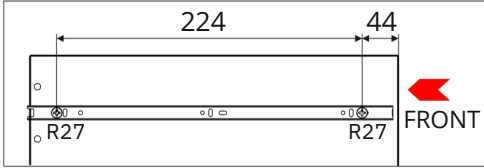

12

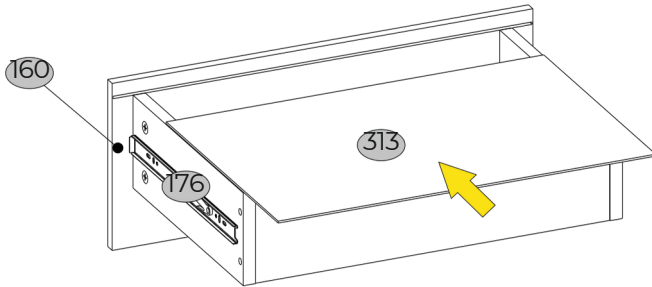

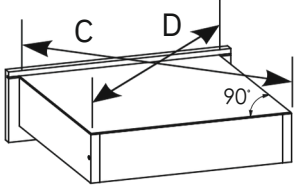
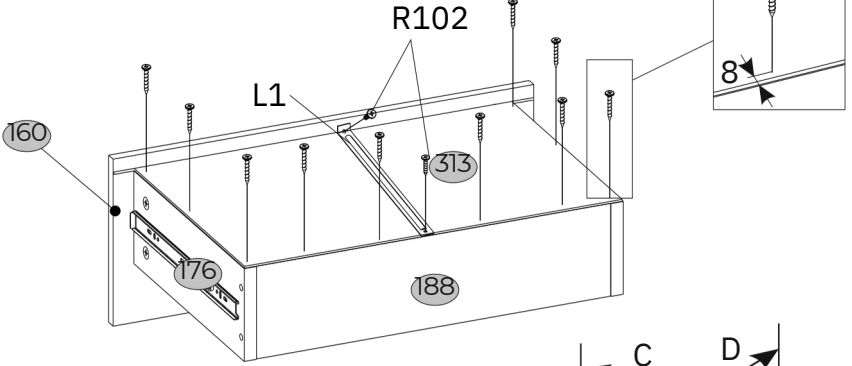

13

L1	R3	R102
320	1 3x20	10 3,5x16

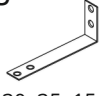

14

B5  10x50	R102  3,5x16	U  130x35x15
2	4	2

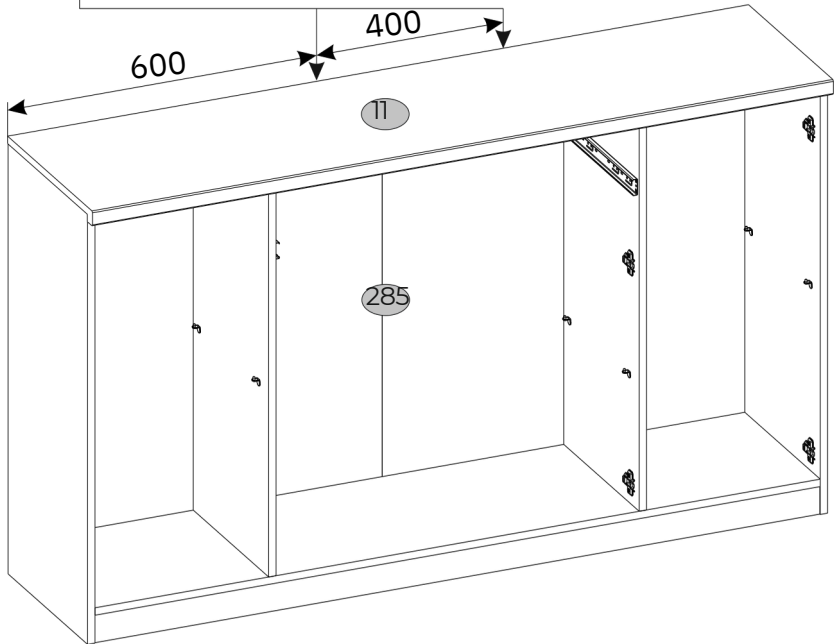
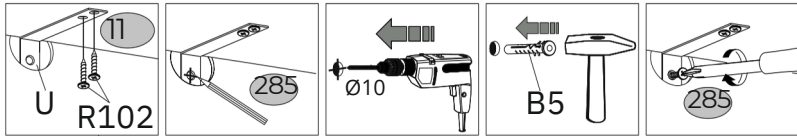
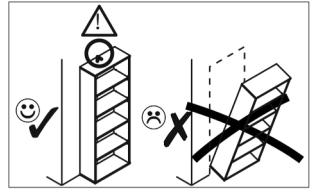

15

S5

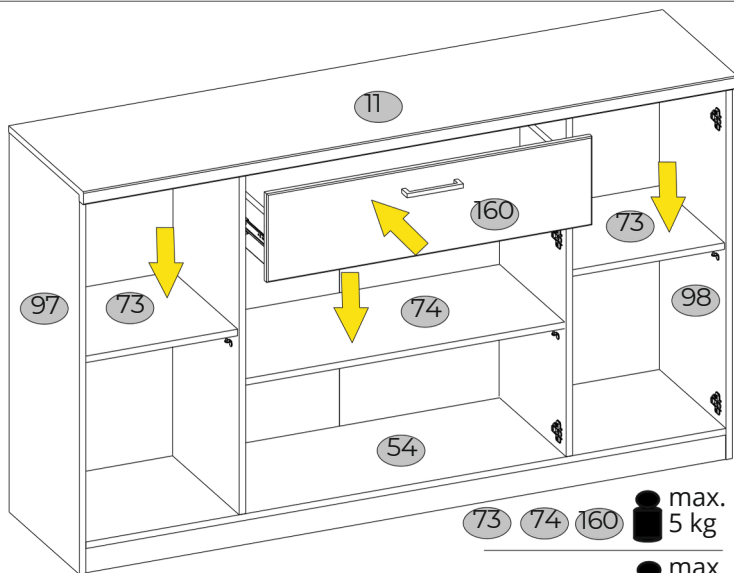
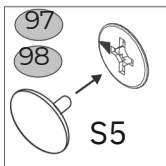
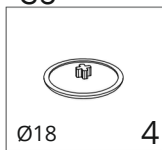

- 73 74 160 max. 5 kg
- 11 54 max. 10 kg

16

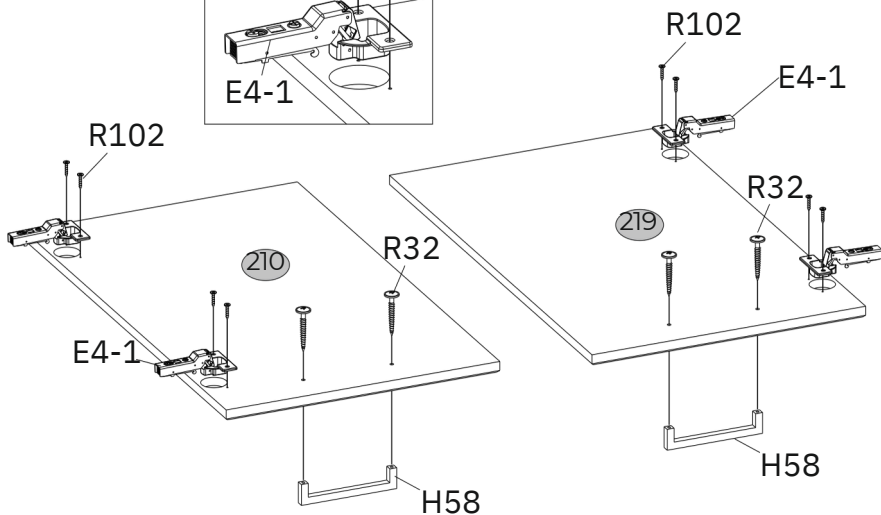
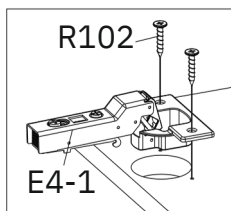
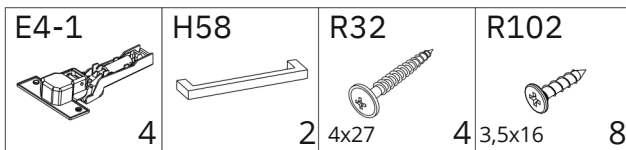

17

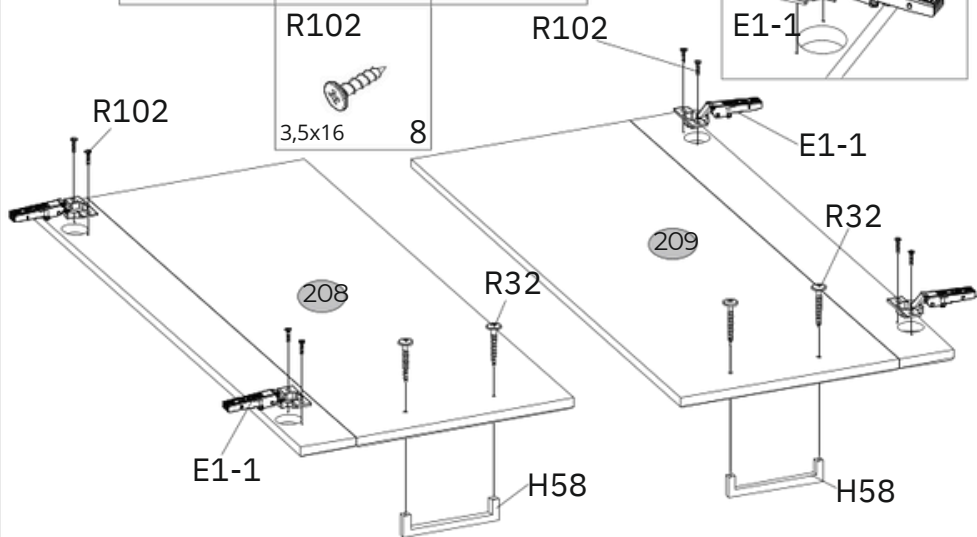
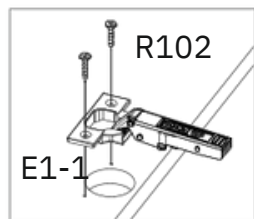
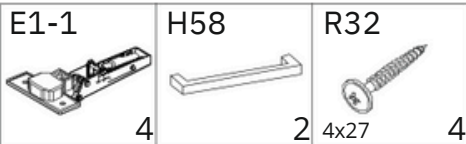

18

