

# Instrukcja montażu mebli

## «DOORSET»

Witryna niska 1w2s

Regał otwarty niski 1d2s

Regał otwarty niski 2s

**A**

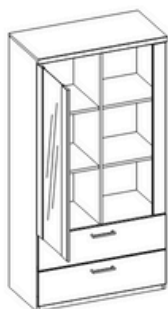

**D**

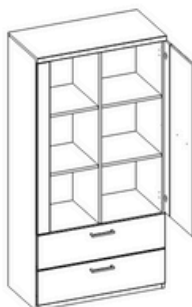

**E**

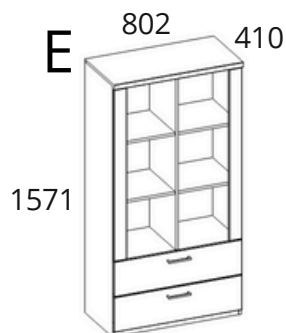

**B**

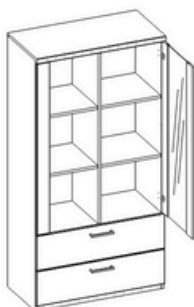

---

Production date  
Data produkcji

---

Stamp of Quality Department  
Pieczęć Działu Jakości

**Witryna niska 1w2s**  
**Cabinet-showcase 1V2S3N**

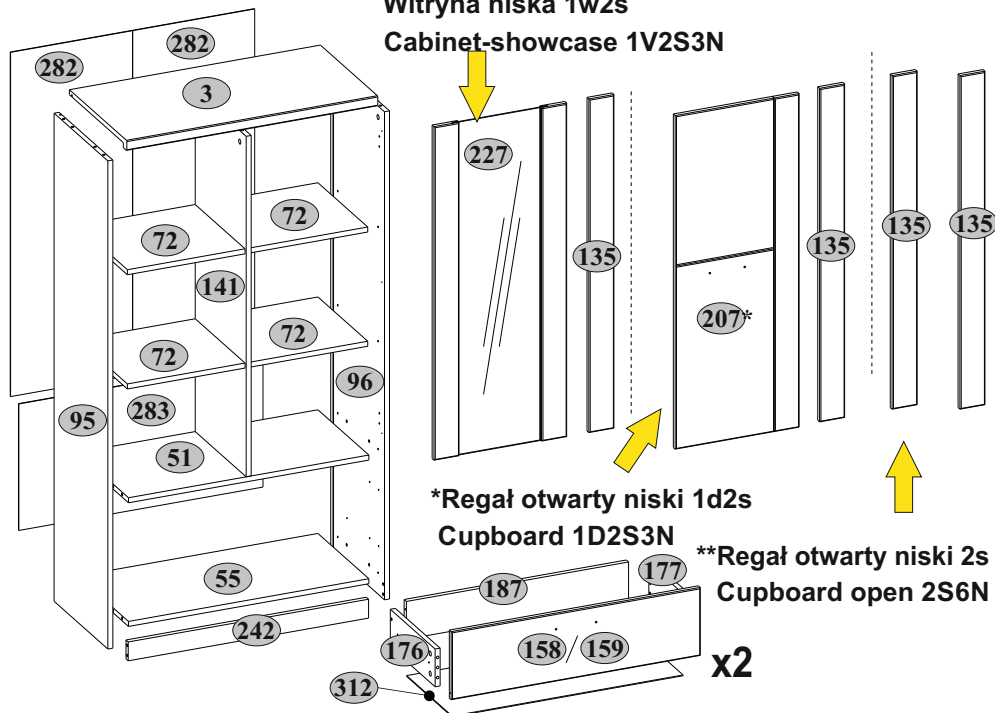

No	L, mm	B, mm	H, mm	Q	No pack
3	802	410	32	1	1/2
51	768	364	16	1	2/2
55	768	364	16	1	2/2
72	376	356	16	4	2/2
95	1551	384	16	1	2/2
96	1551	384	16	1	2/2
135	1060	80	16	1(1*,2**)	1/2
141	1082	364	16	1	1/2
158	796	216	16	1	1/2
159	796	216	16	1	1/2
176	320	120	16	2	1/2
177	320	120	16	2	1/2
187	710	120	16	2	1/2
207*	396	1060	16	1	1/2
227	424	1060	16	1	1/2
242	768	60	16	1	1/2
282	1094	390	2,5	2	1/2
283	402	780	2,5	1	1/2
312	740	325	2,5	2	2/2

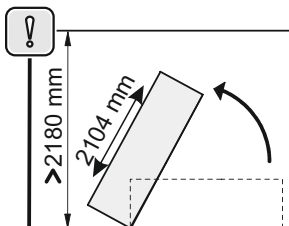
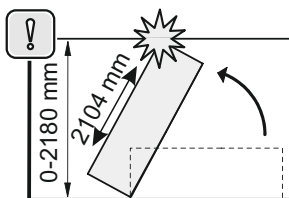

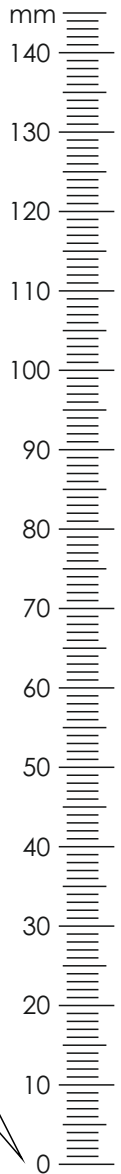

<b>A1</b>  7x34 22	<b>A2</b>  Ø15x12 22	<b>B5</b>  10x50 1	<b>C1</b>  8x35 28
<b>D1-1</b>  2(2*,0**)	<b>E1-1</b>  2(2*,0**)	<b>I</b>  S4 1	<b>H58</b>  2(3*,2**)
<b>N1</b>  4	<b>P5</b>  16	<b>L1</b>  320 2	<b>R3</b>  3x20 33
<b>R23</b>  6,3x13 4(4*,0**)	<b>R24</b>  7x50 10	<b>R27</b>  5,0x13 20	<b>R32</b>  4x27 4(6*,4**)
<b>R102</b>  3,5x16 16(16*,18**)	<b>S1</b>  16	<b>S3</b>  9	<b>S5</b>  Ø18 14
<b>S11</b>  Ø8 4(4*,8**)	<b>U</b>  130x35x15 1	<b>U21</b>  26x26x20 3(3*,6**)	<b>Z10</b>  300 2

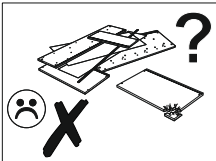
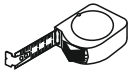
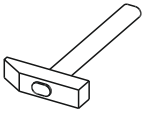
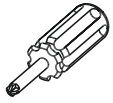
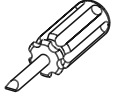



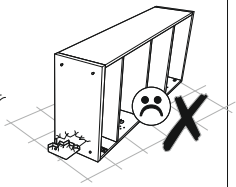
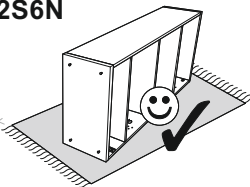
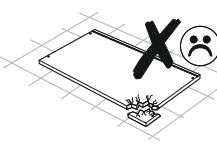
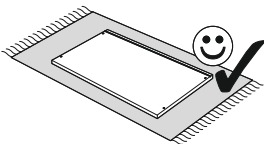
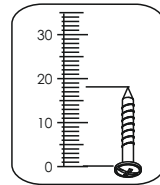

**Witryna niska 1w2s  
Cabinet-showcase 1V2S3N**

**\*Regał otwarty niski 1d2s  
Cupboard 1D2S3N**

**\*\*Regał otwarty niski 2s  
Cupboard open 2S6N**

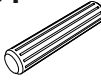

1

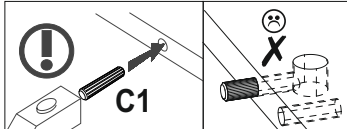
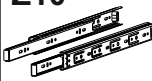
<b>A1</b>  7x34 8	<b>C1</b>  8x35 4	<b>N1</b>  4	<b>P5</b>  8	<b>R27</b>  5,0x13 12
				<b>Z10</b>  300 2

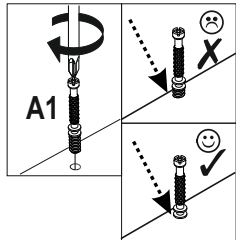
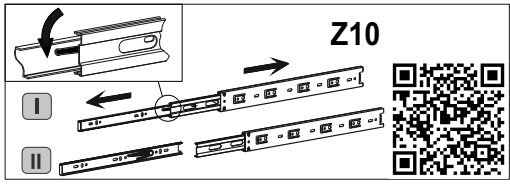
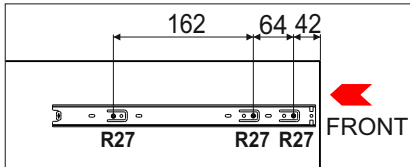
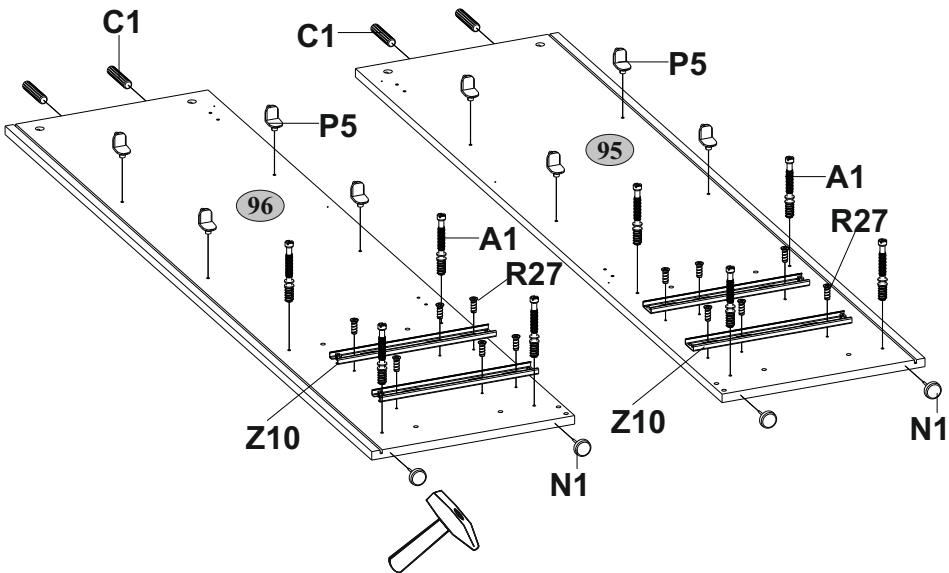

**2****C1**

8x35

12

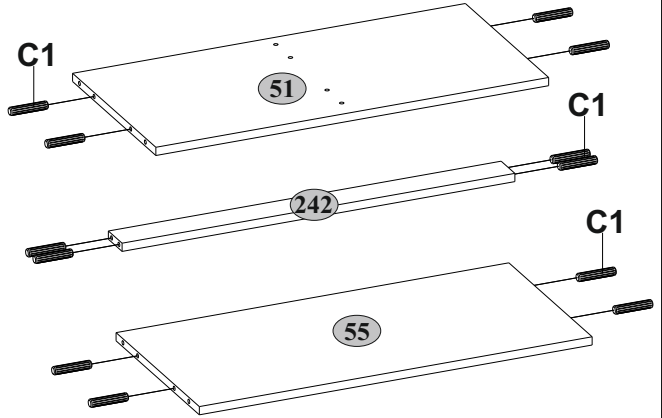
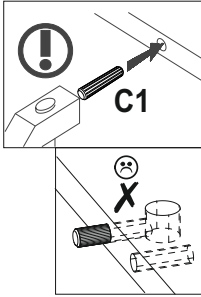
**3****C1**

8x35

4

**P5**

8

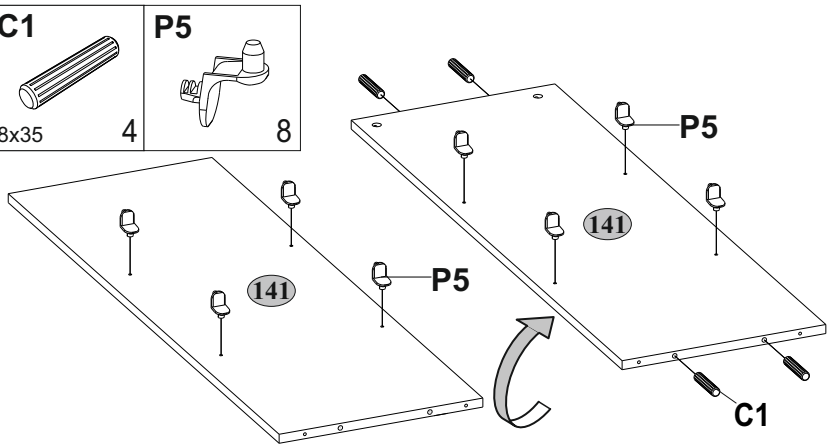
**4****A1**

7x34

6

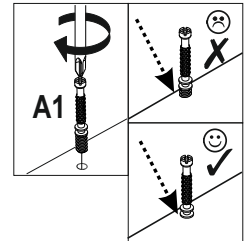
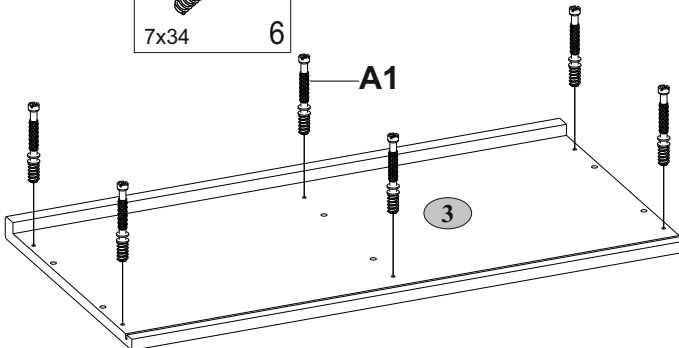

5

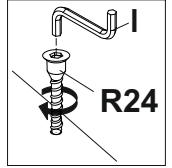
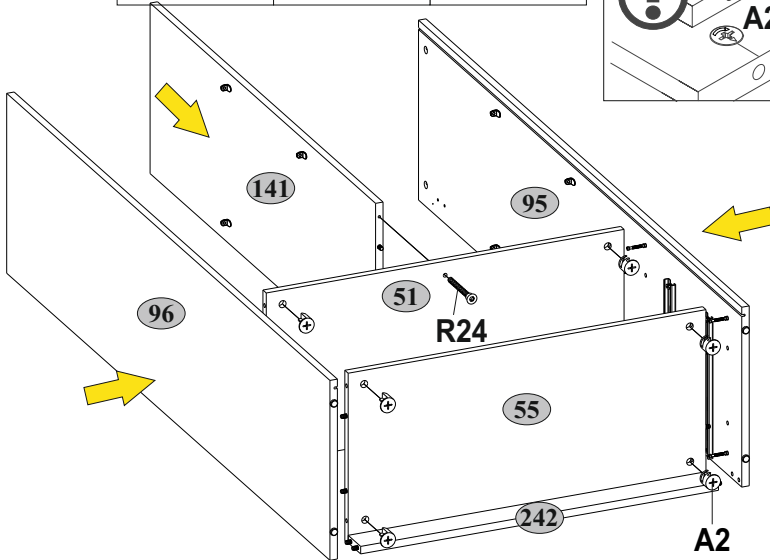
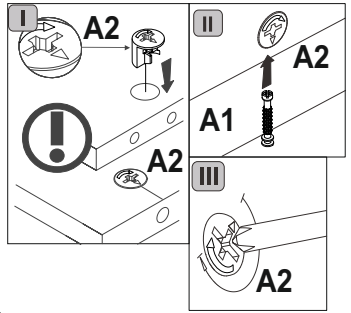
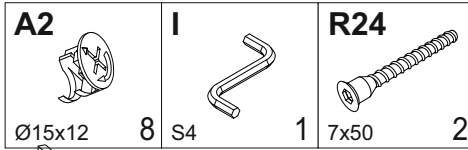

6

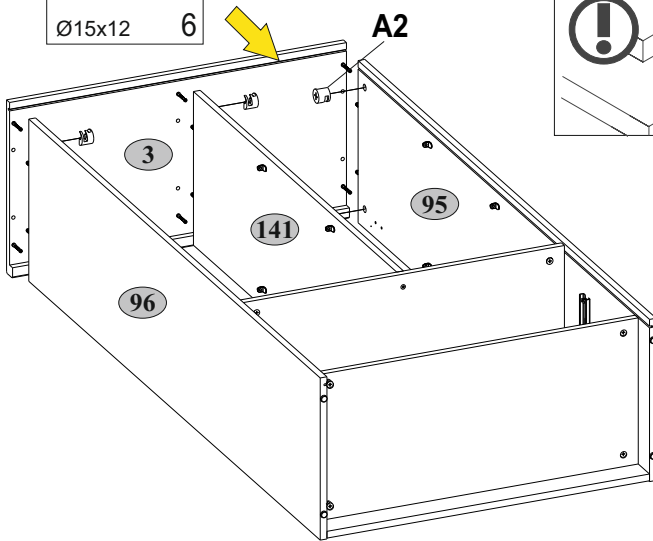
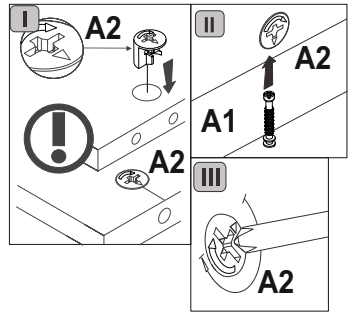
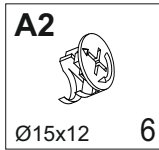

7

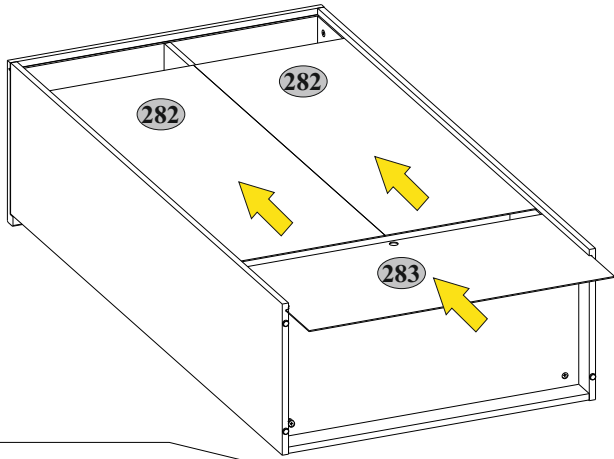



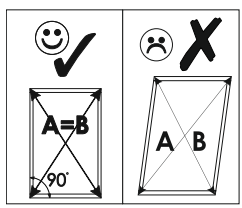
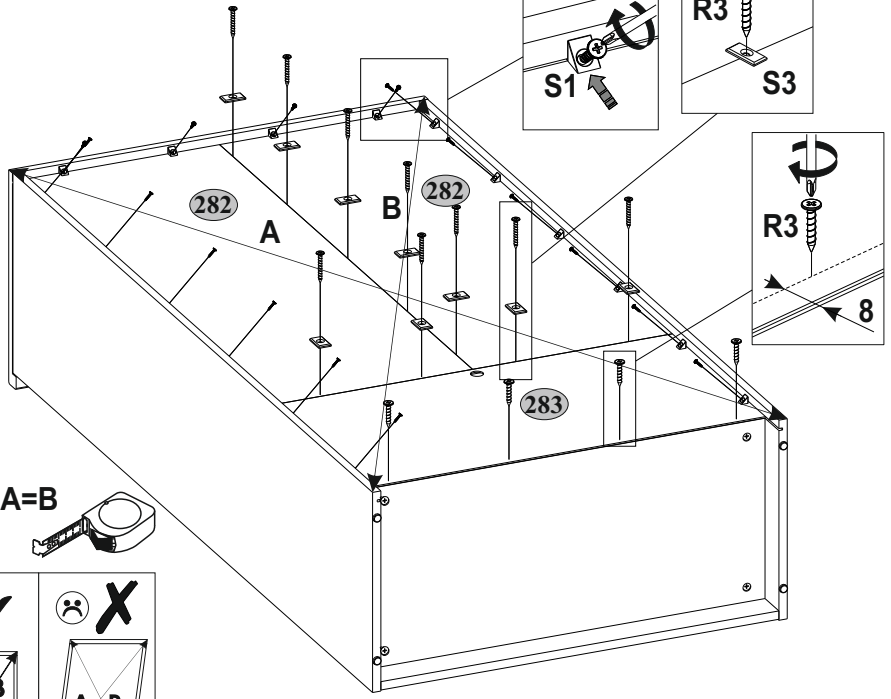
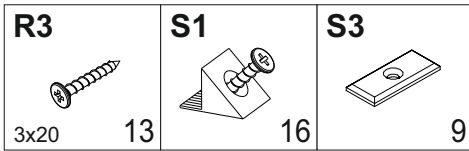





8

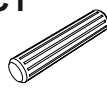

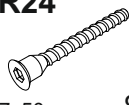
**9**

x2

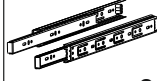
<b>A1</b>  7x34 8	<b>A2</b>  Ø15x12 8	<b>C1</b>  8x35 8	<b>I</b>  S4 1	<b>H58</b>  2(2*,2**)
<b>R24</b>  7x50 8	<b>R27</b>  5,0x13 8	<b>R32</b>  4x27 4(4*,4**) 8	<b>S5</b>  Ø18 8	<b>Z10</b>  300 2

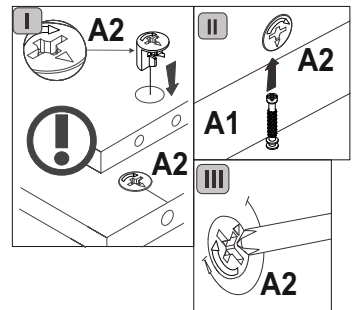
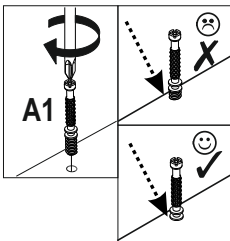
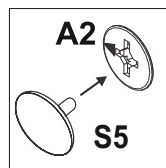
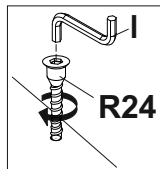
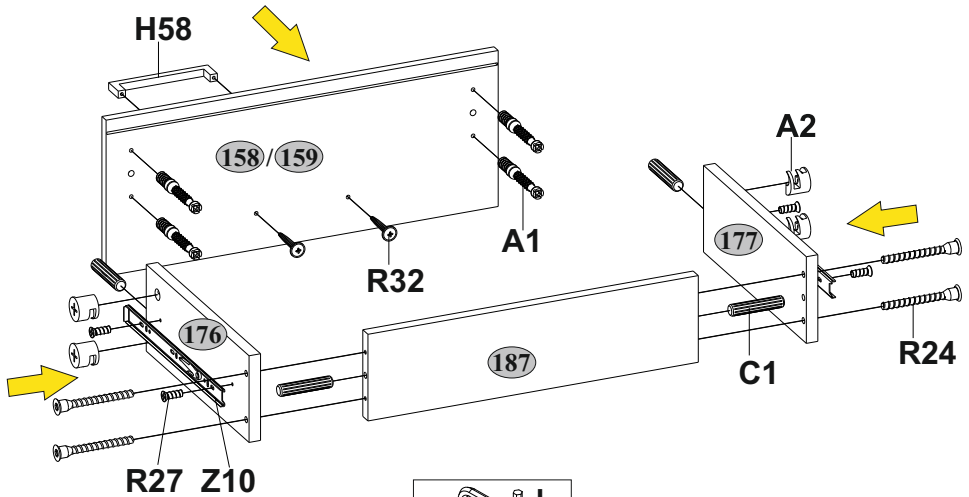
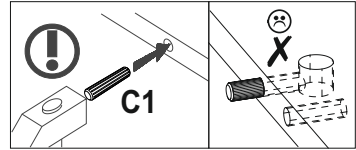
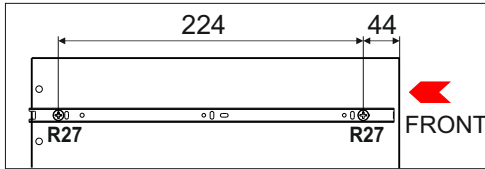



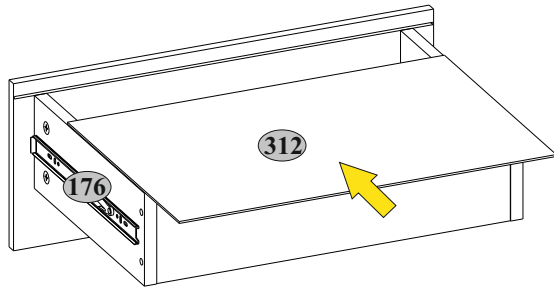

**10**  
x2



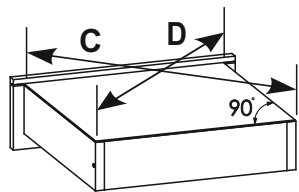
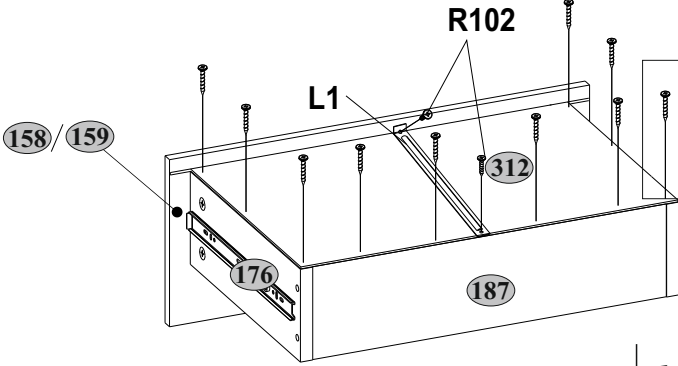

**11**  
x2

<b>L1</b>  320	<b>R3</b>  2 3x20	<b>R102</b>  20 3,5x16 4(4*,4**)
---	--	---

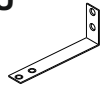

12

<b>B5</b>  10x50	<b>R102</b>  1 3,5x162(2*,2**)	<b>U</b>  130x35x15 1
---	---	--

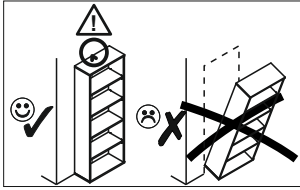
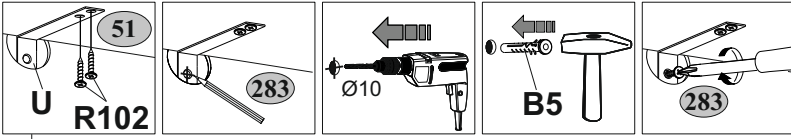

13

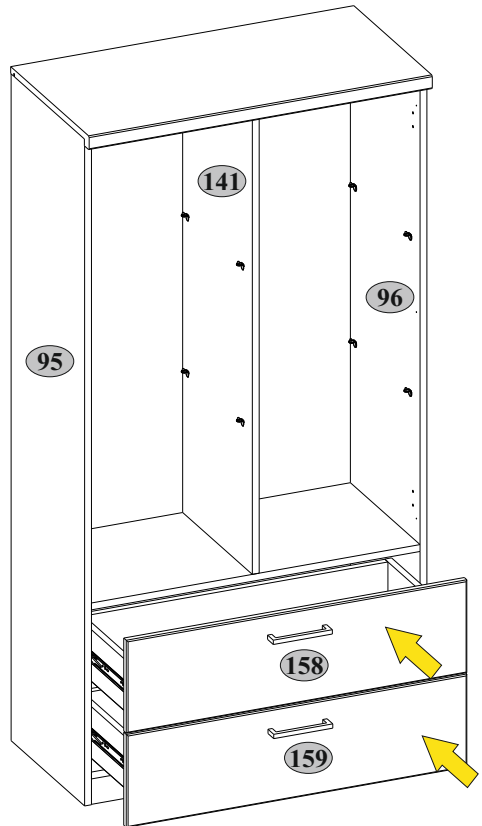
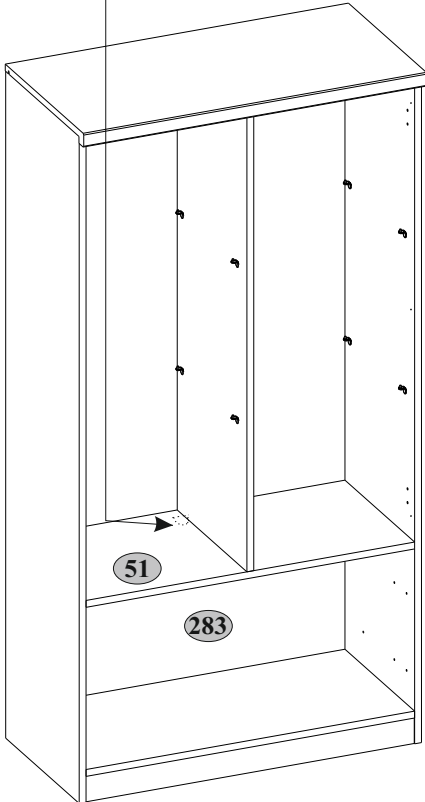
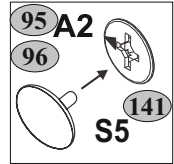
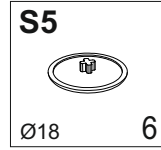

14

D1-1

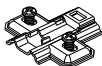

2(2\*)

R23



6,3x13 4(4\*)

S11



∅8 4(4\*)

E1-1+D1-1

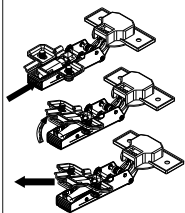

72 51 158 159

max. 5 kg



3 max. 10 kg

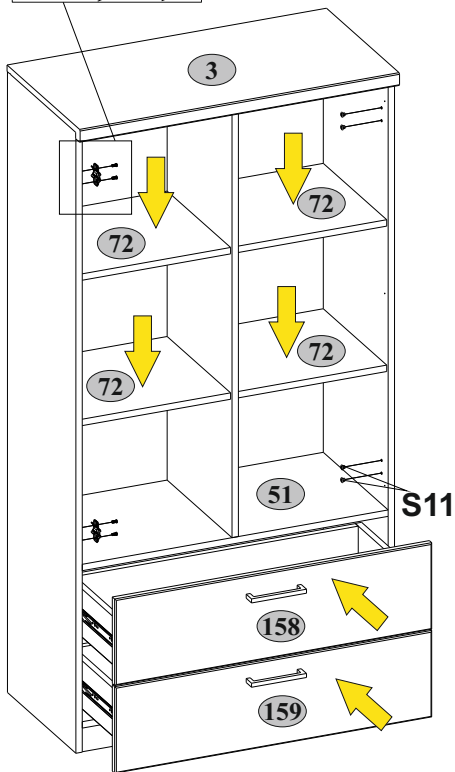
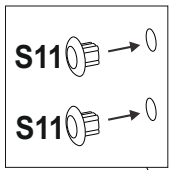
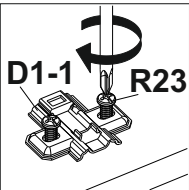

A

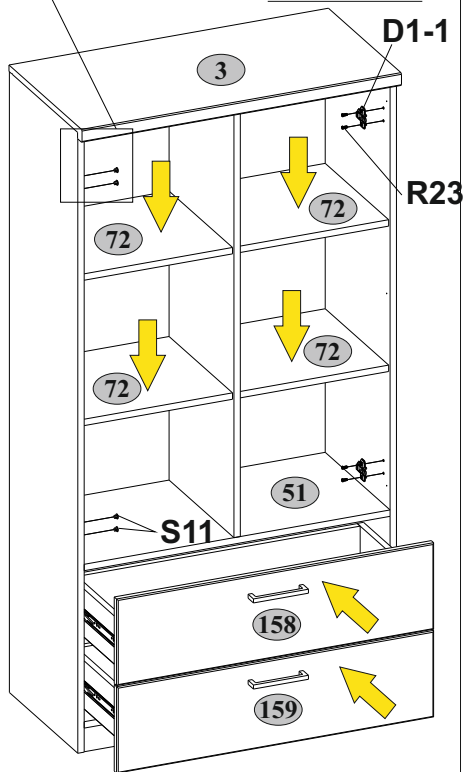
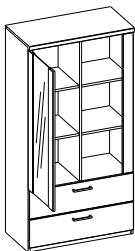

B

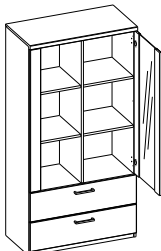

D

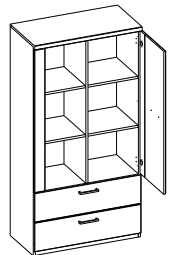

15

E1-1

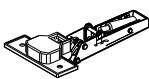

2

U21



26x26x20

R102



3,5x16 10

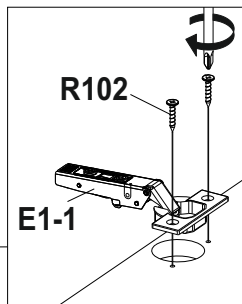

R102

E1-1

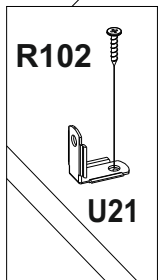

R102

U21

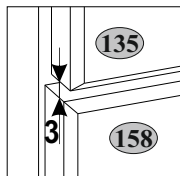

3



A

B

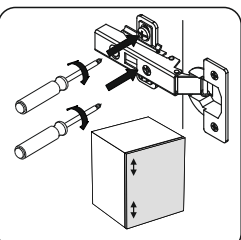
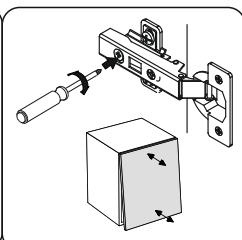
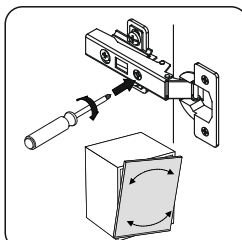
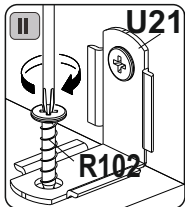
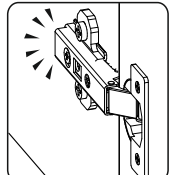
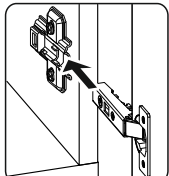
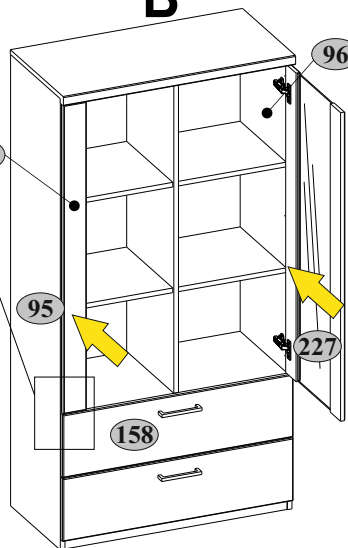
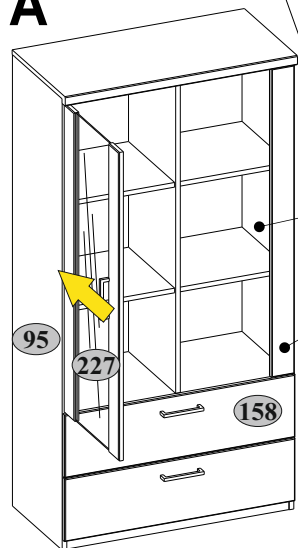

16

E1-1

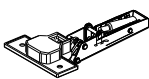

2\*

U21

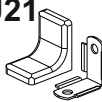

26x26x20 3\*

H58



1\*

R32



4x27 2\*

R102



3,5x16 10\*

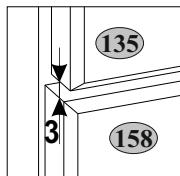
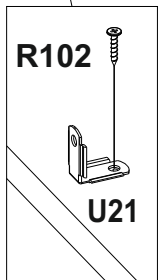
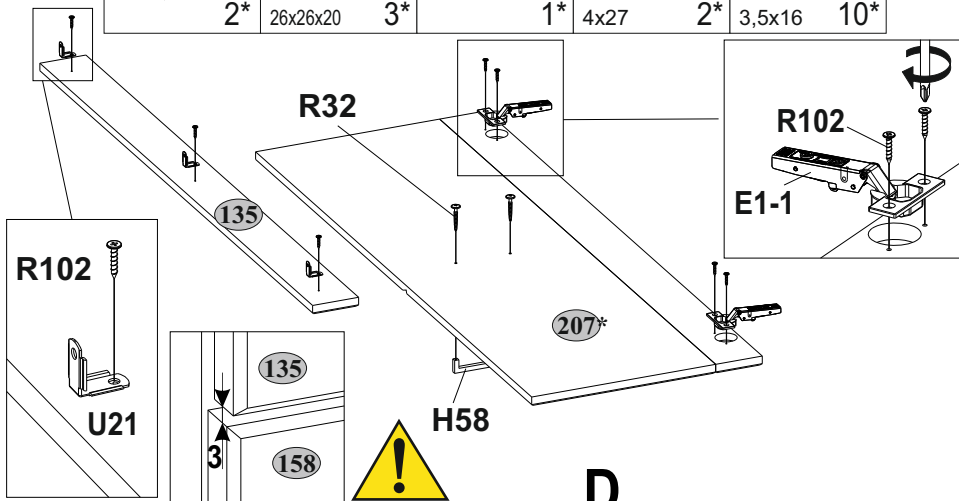

D

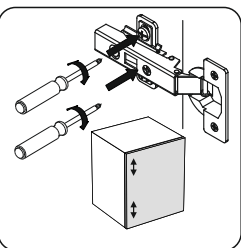
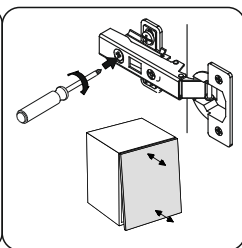
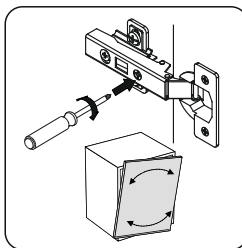
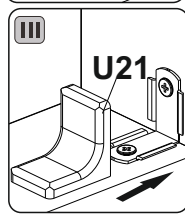
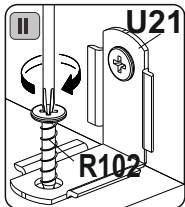
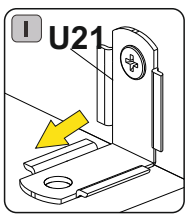
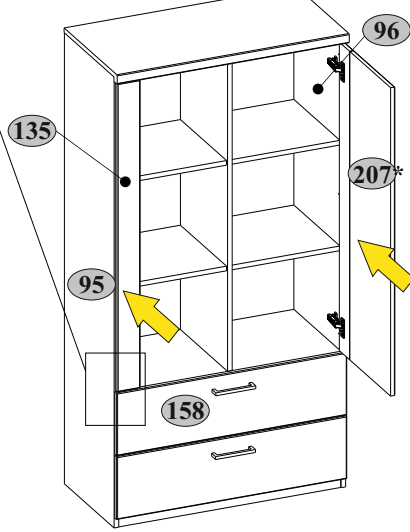
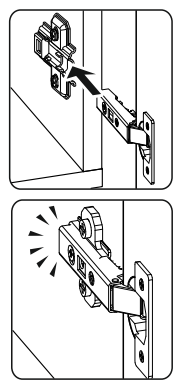

17

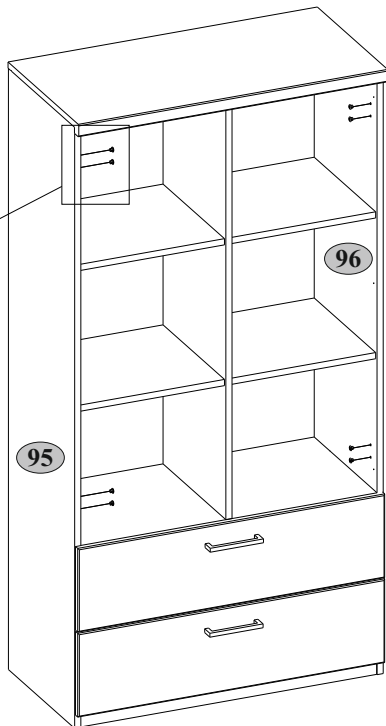
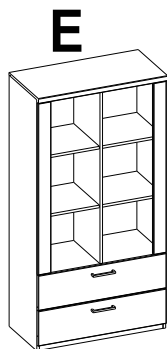
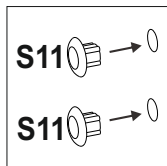

18

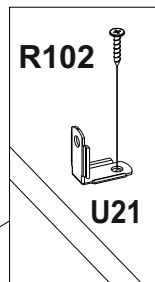
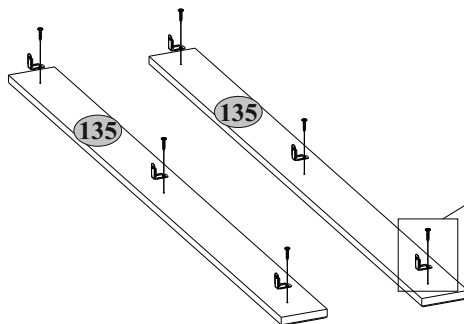
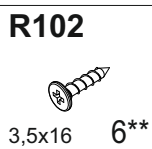
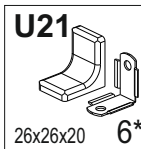

19

R102



3,5x16

6\*\*

E

