

# Instrukcja montażu mebli

## «DOORSET»

Witryna wysoka 1w2s

Regał 1d2s

Regał otwarty wysoki 2s

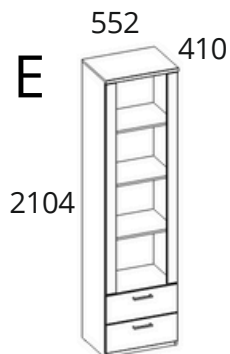
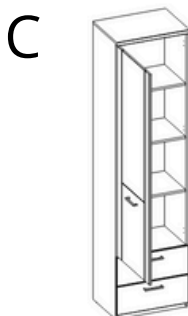
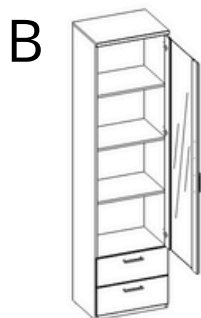

---

Production date  
Data produkcji

---

Stamp of Quality Department  
Pieczęć Działu Jakości

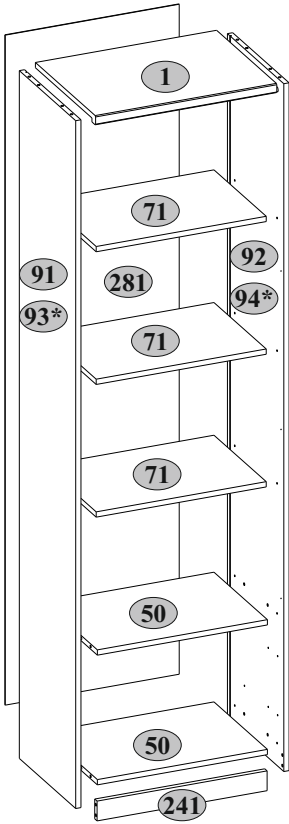

\* Regał otwarty wysoki 2s  
Cupboard open 2S4N

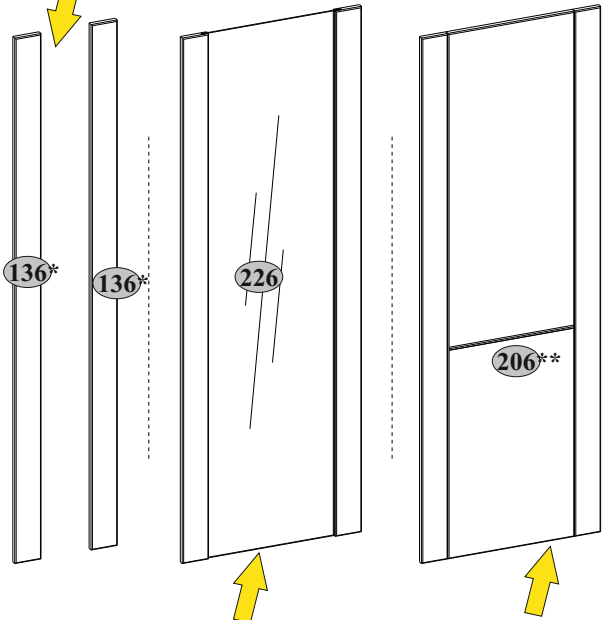

Witryna wysoka 1w2s  
Cabinet-showcase 1V2S

\*\* Regał 1d2s  
Cupboard 1D2S

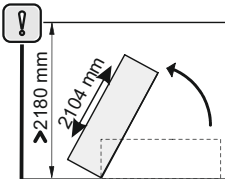
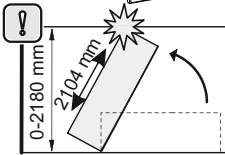
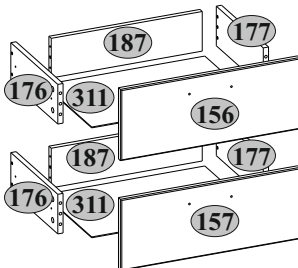

No	L, mm	B, mm	H, mm	Q	No pack
1	552	400	32	1	1/2
50	518	364	16	2	1/2
71	518	356	16	3	1/2
91(93*)	2084	384	16	1	2/2
92(94*)	2084	384	16	1	2/2
136*	1592	80	16	2	2/2
156	546	216	16	1	2/2
157	546	216	16	1	2/2
176	320	120	16	2	1/2
177	320	120	16	2	1/2
187	460	120	16	2	1/2
241	518	60	16	1	2/2
206**	546	1592	16	1	2/2
226	546	1592	16	1	2/2
281	2030	530	2,5	1	2/2
311	490	325	2,5	2	1/2

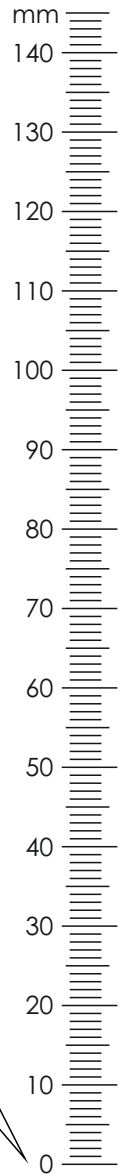

<b>A1</b>  7x34 20	<b>A2</b>  Ø15x12 20	<b>B5</b>  10x50 1	<b>C1</b>  8x35 24
<b>D1-1</b>  3(0*,3**)	<b>E1-1</b>  3(0*,3**)	<b>I</b>  S4 1	<b>H58</b>  3(2*,3**)
<b>N1</b>  4	<b>P5</b>  12	<b>R3</b>  3x20 20	<b>R23</b>  6,3x13 6(0*,6**)
<b>R24</b>  7x50 8	<b>R27</b>  5,0x13 20	<b>R32</b>  4x27 6(4*,6**)	<b>R102</b>  3,5x16 8(18*,8**)
<b>S1</b>  22	<b>S5</b>  Ø18 12	<b>S11</b>  Ø8 8(0*,8**)	<b>U</b>  130x35x15 1
<b>U21</b>  26x26x20 0(8*,0**)			<b>Z10</b>  300 2

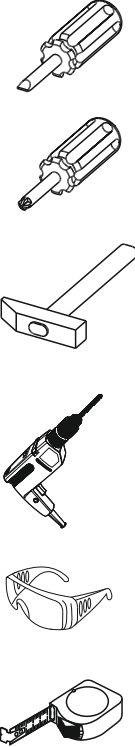

**Witryna wysoka 1w2s  
Cabinet-showcase 1V2S**

\* Regał otwarty wysoki 2s  
Cupboard open 2S4N

\*\* Regał 1d2s  
Cupboard 1D2S

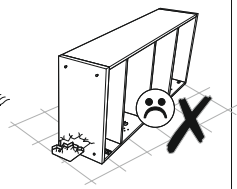
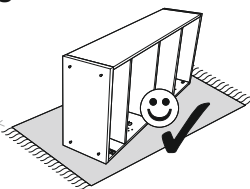
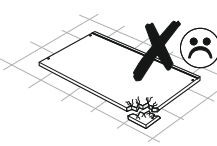
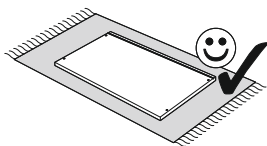
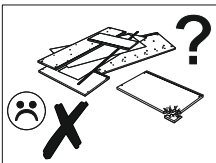
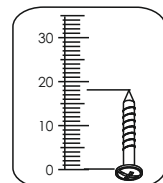

1

A1



7x34

C1

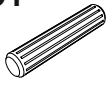

8 8x35

N1



4

P5

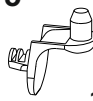

12

R27



5,0x13

12

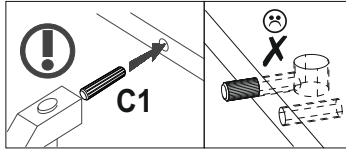

Z10

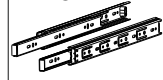

300

2

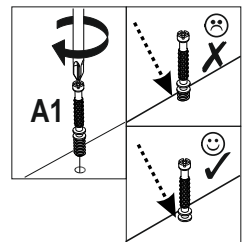
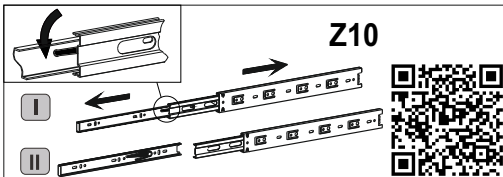
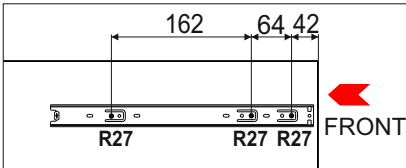
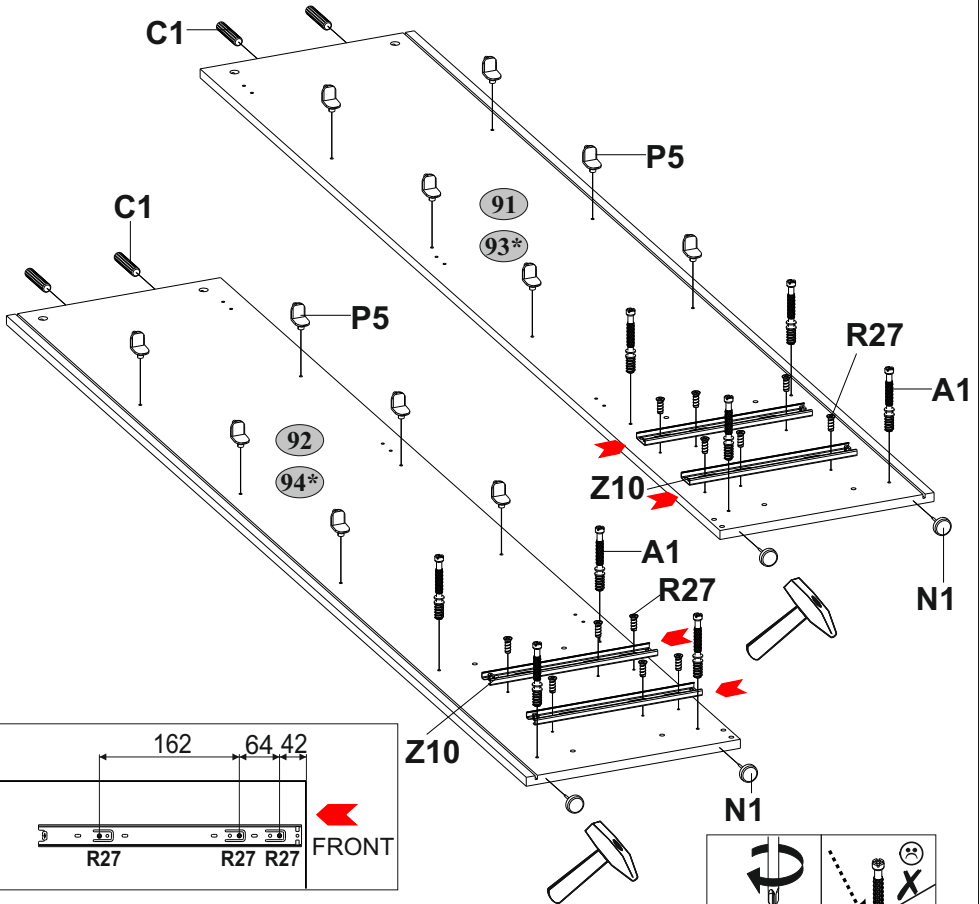

2

C1

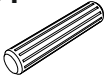

8x35

12

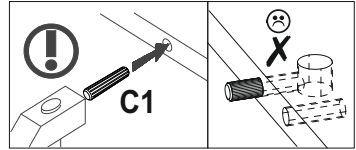
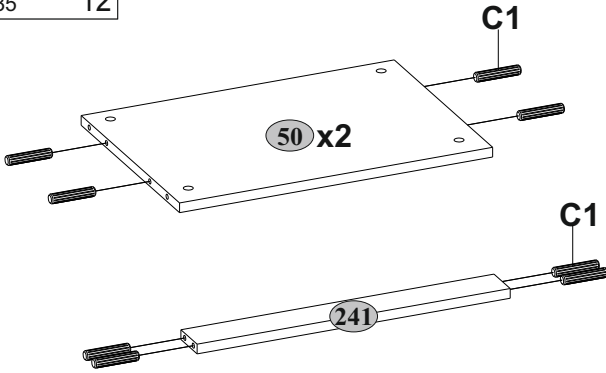

3

A1



7x34

4

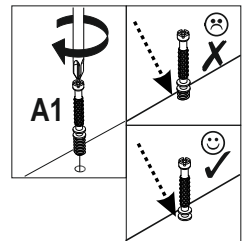
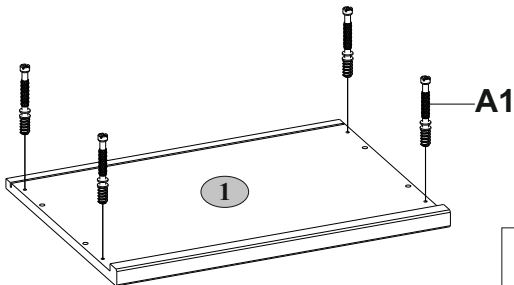

4

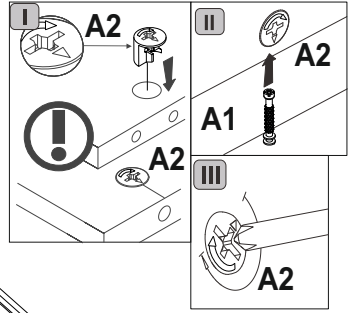
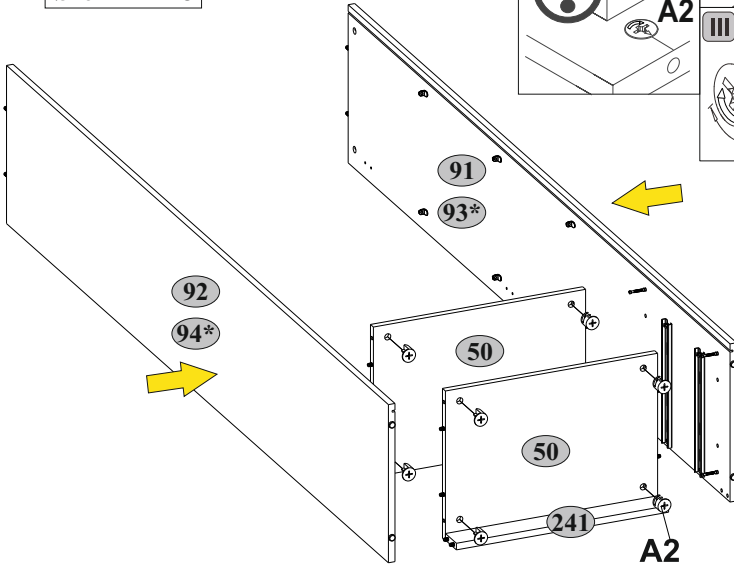
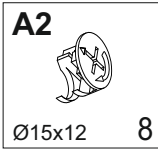



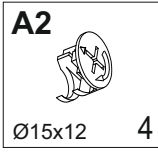
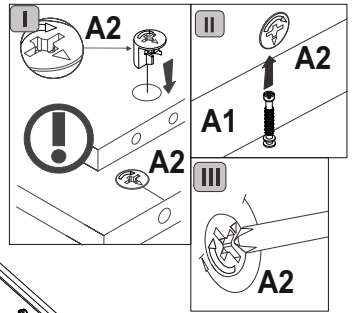
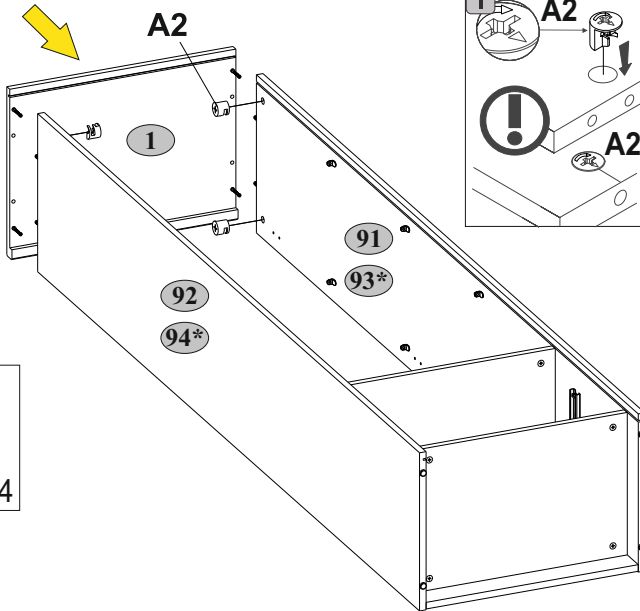





5



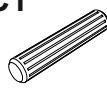

**8**

x2

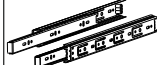
<b>A1</b>  7x34 8	<b>A2</b>  Ø15x12 8	<b>C1</b>  8x35 8	<b>I</b>  S4 1	<b>H58</b>  2
<b>R24</b>  7x50 8	<b>R27</b>  5,0x13 8	<b>R32</b>  4x27 8	<b>S5</b>  Ø18 4	<b>Z10</b>  300 2

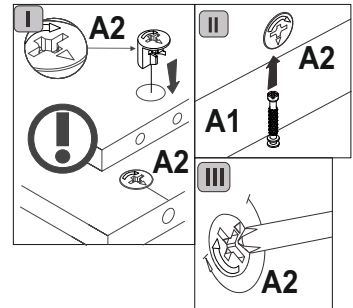
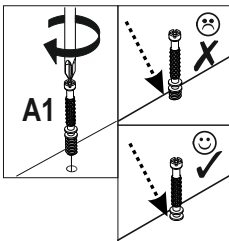
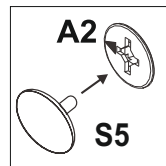
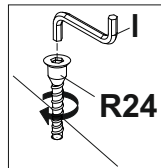
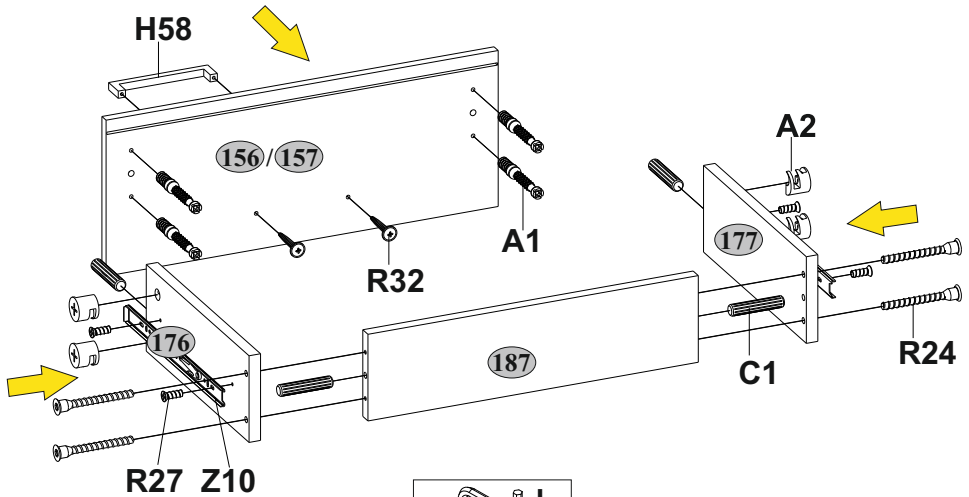
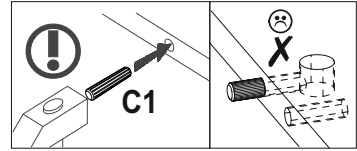
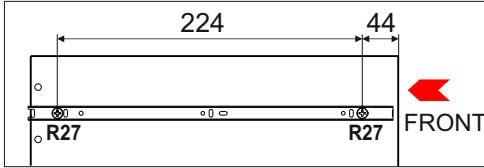



9

x2

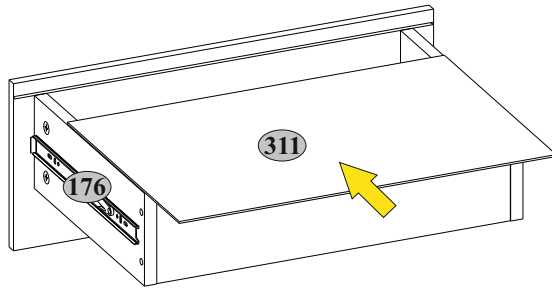

10

x2

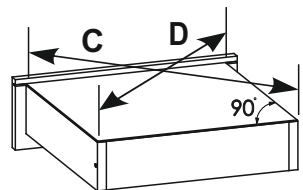
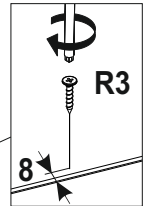
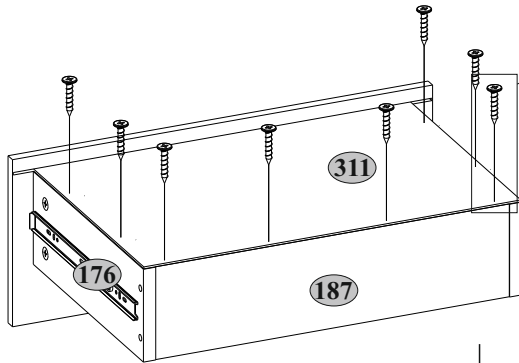
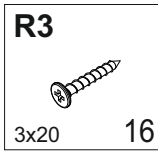

11

B5

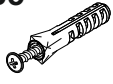

10x50

1

R102



3,5x16

2

S5



Ø18

U





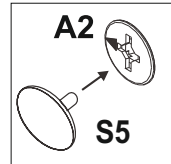
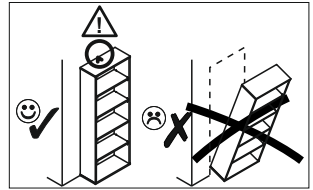
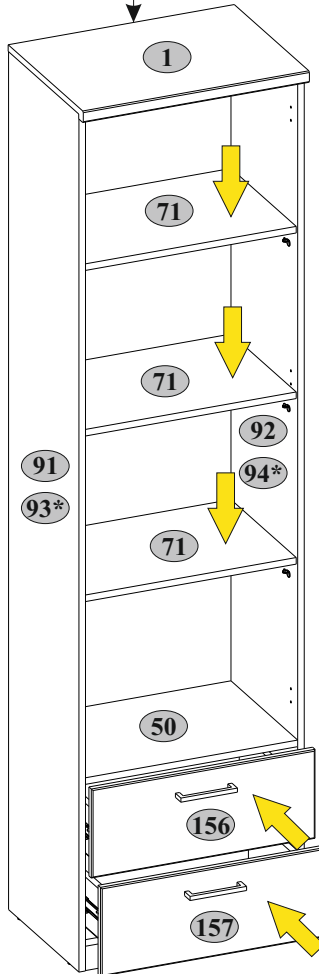
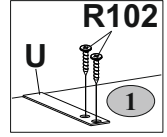
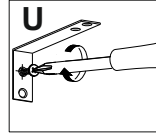
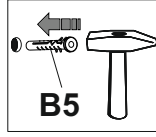
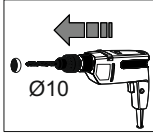
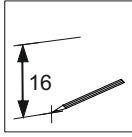
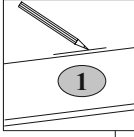

130x35x15

1

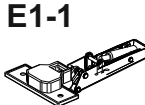

1	50	max. 5 kg
71	156 157	

12

<b>E1-1</b>  3	<b>H58</b>  1	<b>R32</b>  4x27	<b>R102</b>  3,5x16	<b>S11</b>  2
--	---	--	---	---

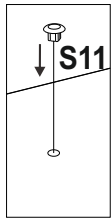
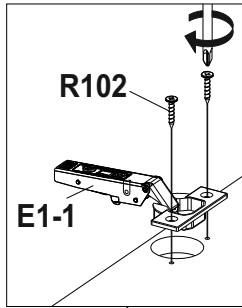

**A**

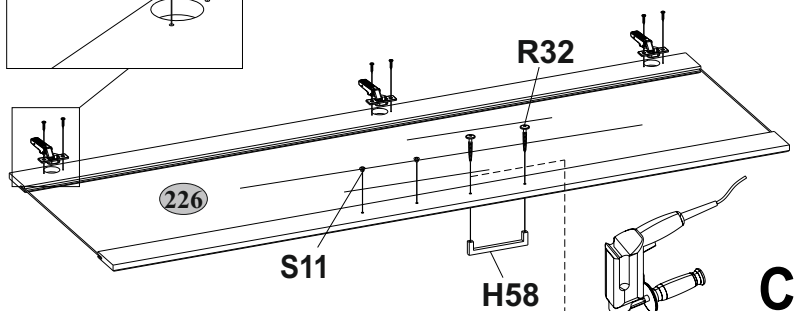
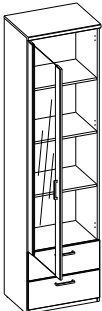



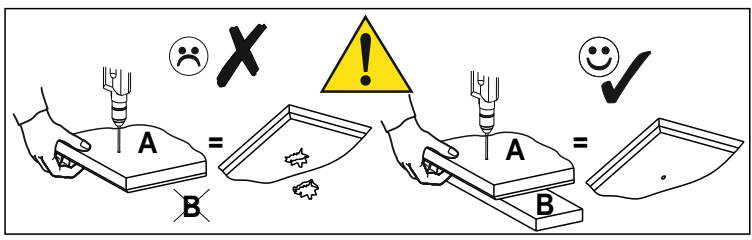
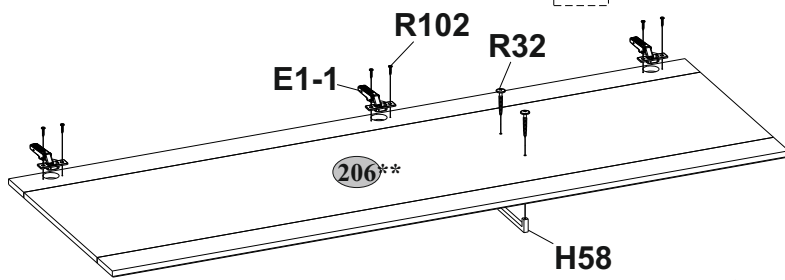
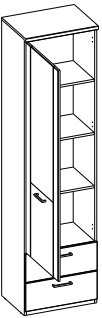

**C**

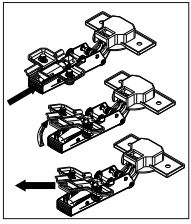

**E1-1+D1-1**

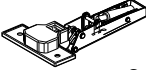

12

<b>E1-1</b>  3	<b>H58</b>  1	<b>R32</b>  4x27	<b>R102</b>  3,5x16	<b>S11</b>  2
---	--	---	--	--

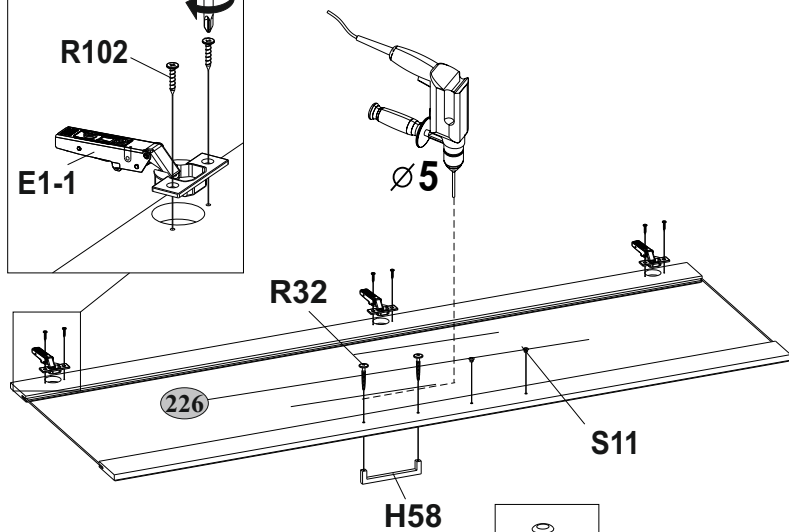
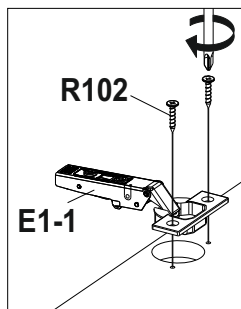

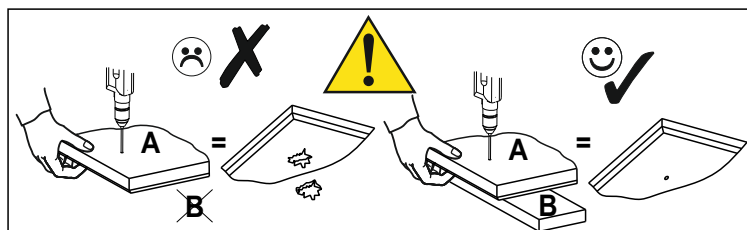
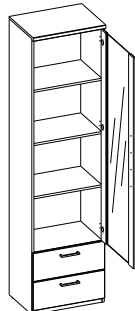

**B**

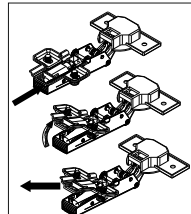

**E1-1+D1-1**

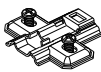

13

<b>D1-1</b>  3	<b>R23</b>  6,3x13	<b>S11</b>  6 Ø8
---	---	---

**B**

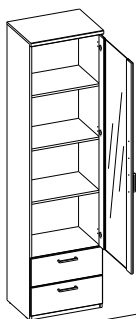

**A**

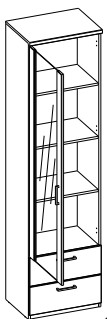

**C**

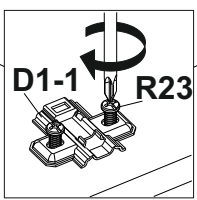
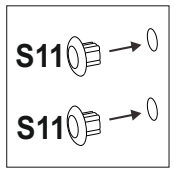
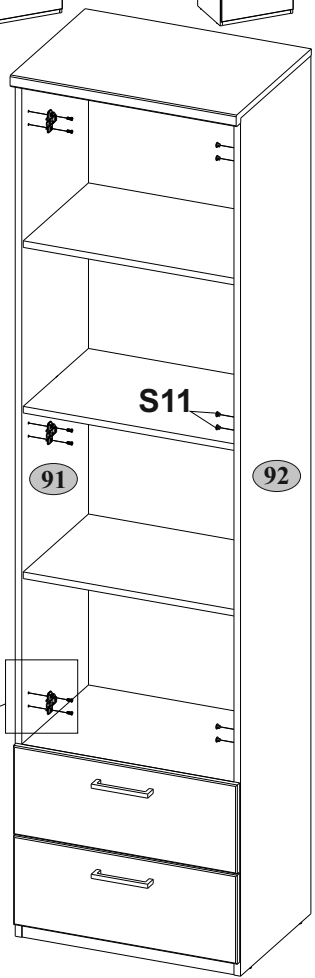
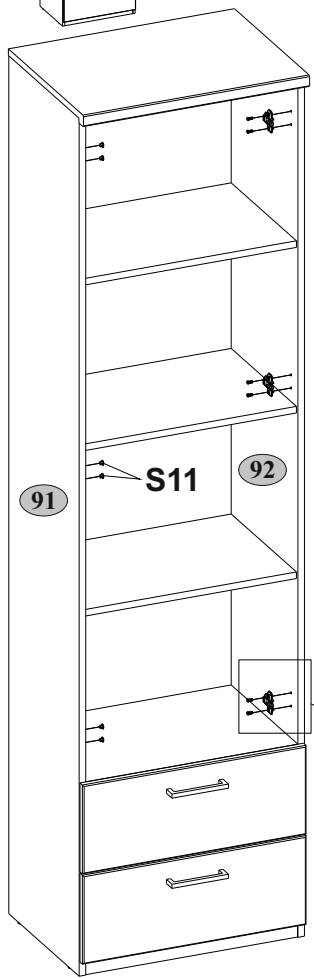
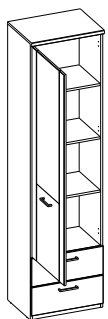

14

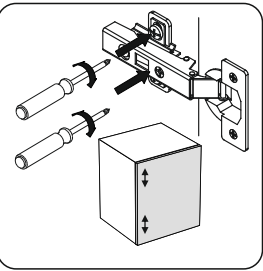
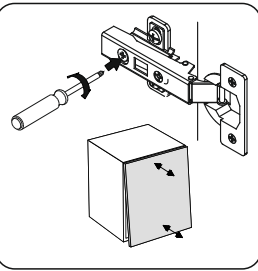
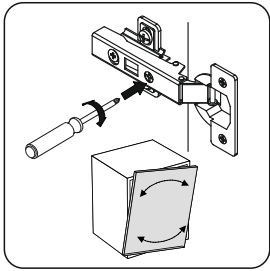
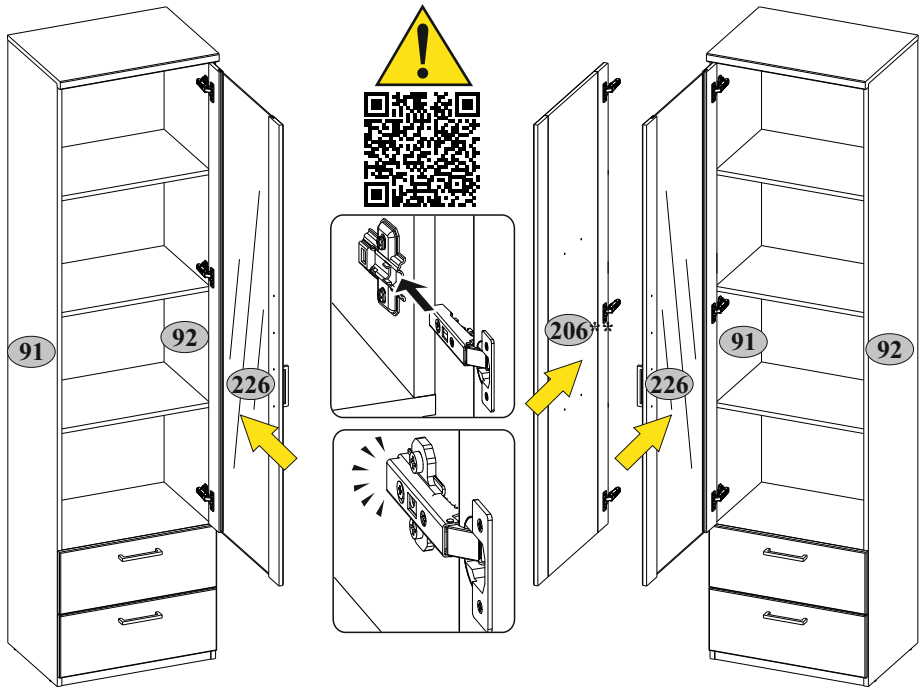
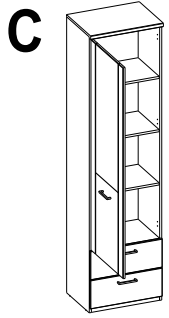
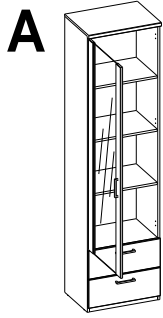
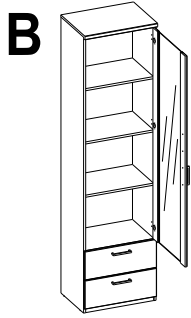

12

x2

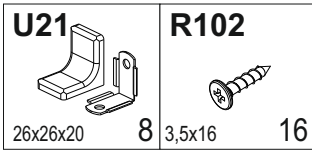

E

