

# Instrukcja montażu mebli

## «DOORSET»

Półka 80

Półka 135

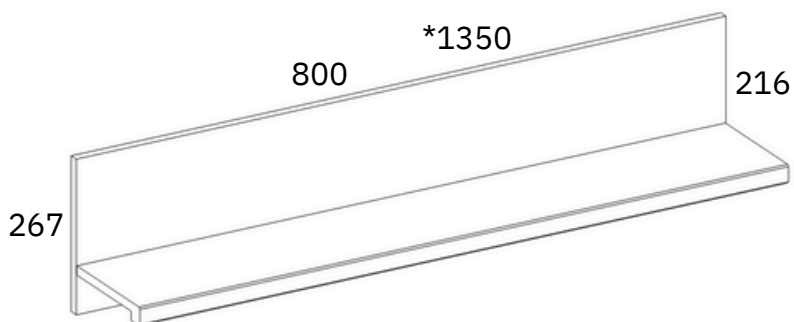

---

Production date  
Data produkcji

---

Stamp of Quality Department  
Pieczęć Działu Jakości



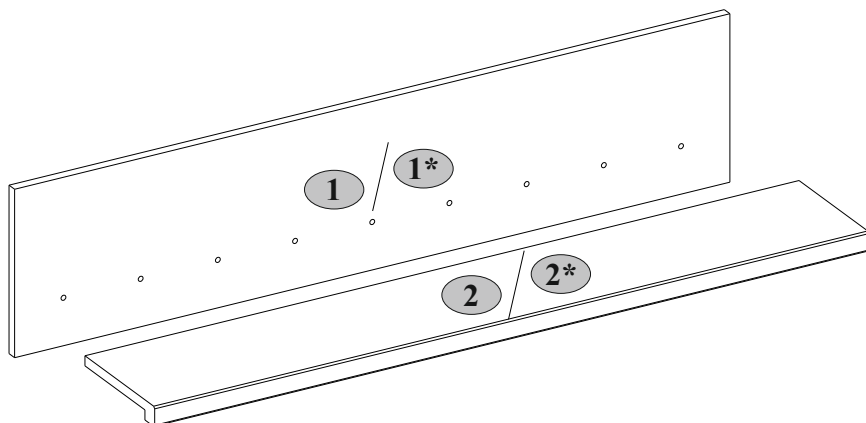

№	L, mm	B, mm	H, mm	Q	№ pack
1	800	267	16	1	1/1
2	798	200	32	1	1/1
1*	1350	267	16	1	1/1
2*	1348	200	32	1	1/1

**Shelf T**  
**Półka 80**

**\* Shelf BT**  
**\* Półka 135**

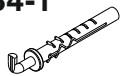

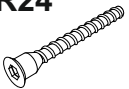

<b>B3</b>  Ø35      2	<b>B4-1</b>  10x50      2	<b>C1</b>  8x35      2, *4
<b>I</b>  S4      1	<b>R24</b>  7x50      3, *5	<b>R27</b>  5,0x13      6

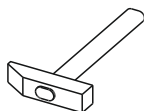
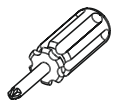
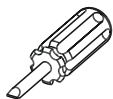
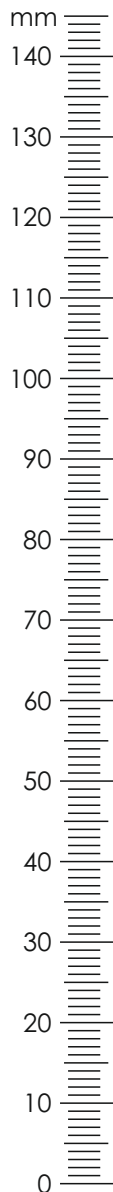

**Shelf T**  
**Półka 80**

**\* Shelf BT**  
**\* Półka 135**

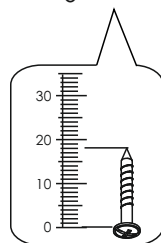
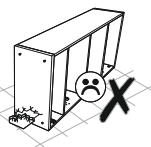
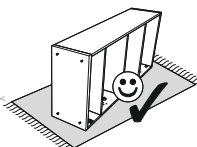
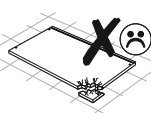
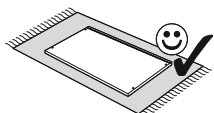
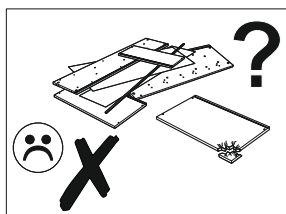

**1**

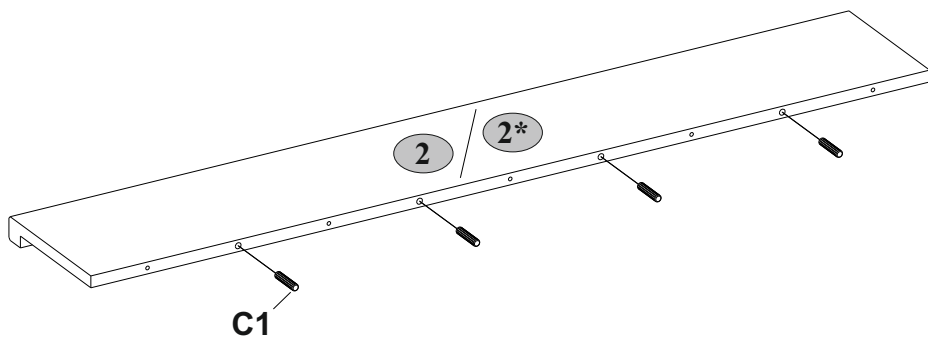
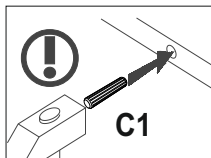
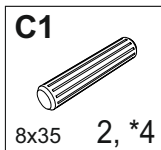

**2**

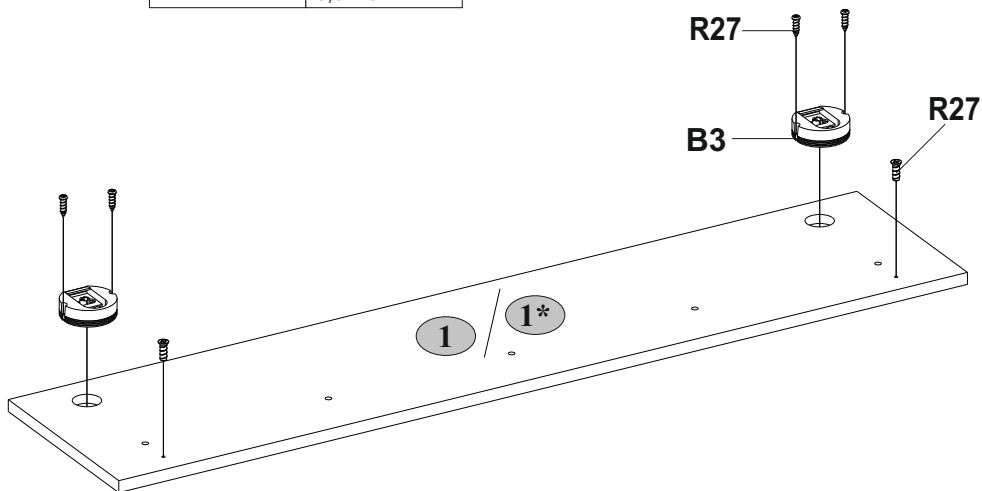
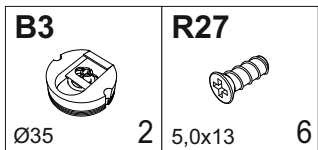

**3**

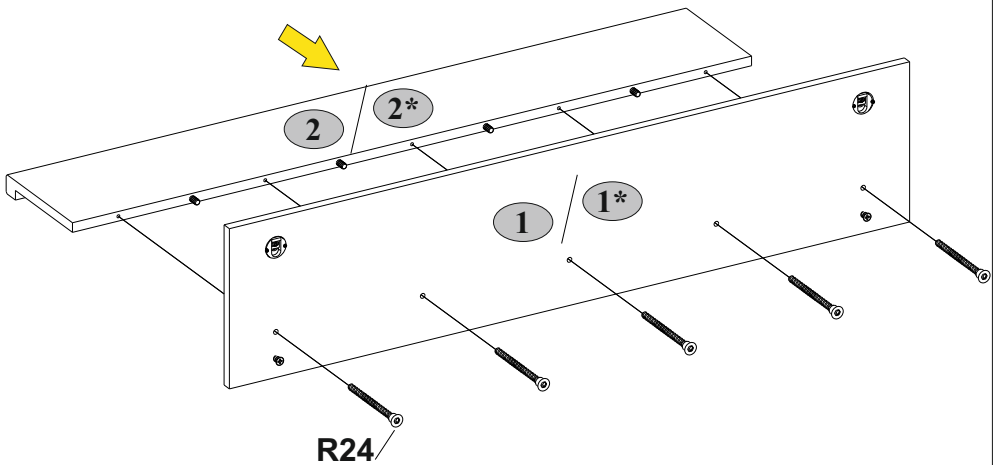
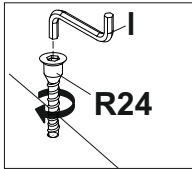
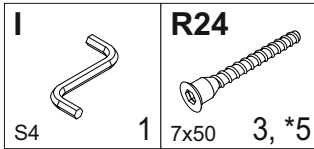

4

B4-1

10x50

2

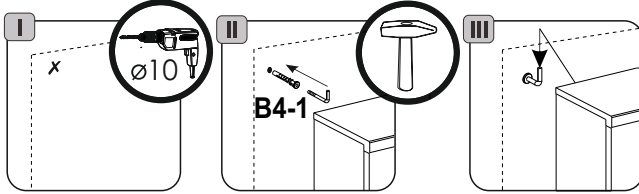
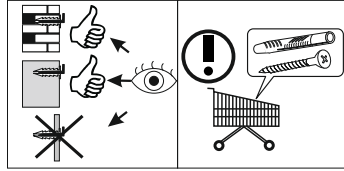

2 / 2\* max. 3 kg

