

# Instrukcja montażu mebli «DOORSET»

Komoda 4s



---

Production date  
Data produkcji







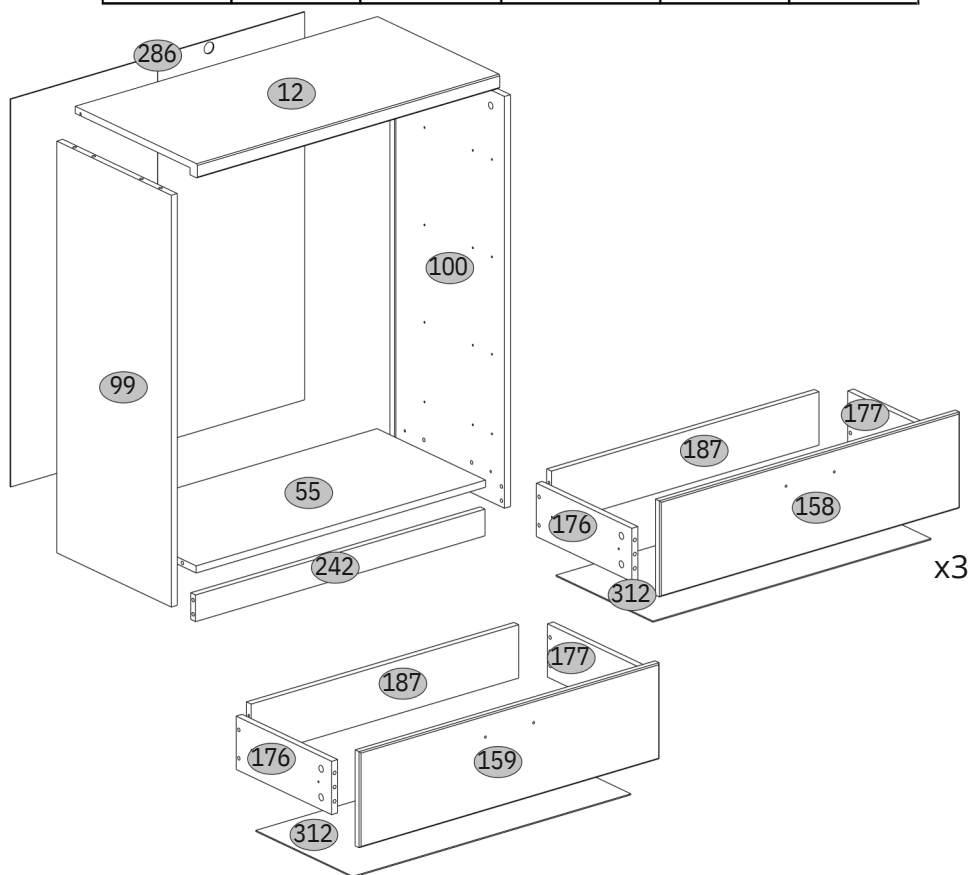





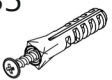
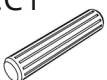

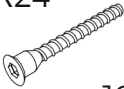

---

Stamp of Quality Department  
Pieczęć Działu Jakości

№	L, mm	B, mm	H, mm	Q	№ pack
12	802	410	32	1	1/2
55	768	364	16	1	1/2
99	926	384	16	1	2/2
100	926	384	16	1	2/2
158	796	216	16	3	1/2
159	796	216	16	1	1/2
176	320	120	16	4	2/2
177	320	120	16	4	2/2
187	710	120	16	4	2/2
242	768	60	16	1	1/2
286	872	780	2,5	1	2/2
312	740	325	2,5	4	1/2







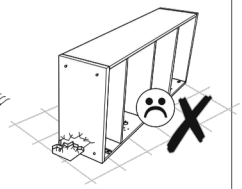
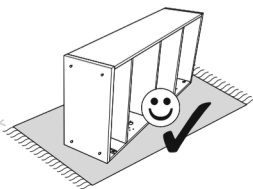
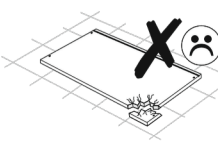
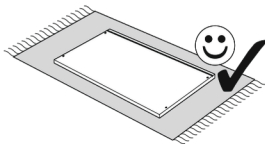
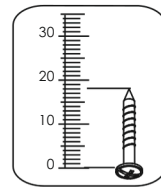
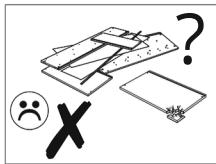
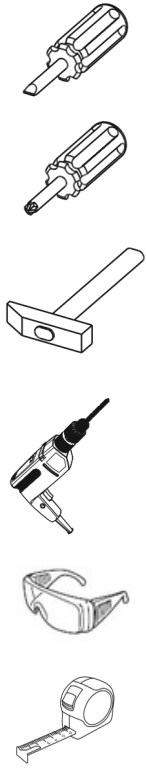

<b>A1</b>  7x34 24	<b>A2</b>  Ø15x12 24	<b>B5</b>  10x50 1	<b>CC1</b>  8x35 4208
<b>H58</b>  4 S4	<b>I</b>  1	<b>L1</b>  320 4	<b>N1</b>  4
<b>R3</b>  3x20 44	<b>R24</b>  7x50 16	<b>R27</b>  5,0x13 40	<b>R32</b>  4x27 8
<b>R102</b>  3,5x16 10	<b>S1</b>  8	<b>S5</b>  Ø18 16	<b>U</b>  130x35x15 1
<b>Z10</b>  300 4			

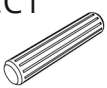

1

A1  7x34	CC1  4 8x35	N1  4 4	R27  4 5,0x13	Z10  24 300
---	--	--	--	--

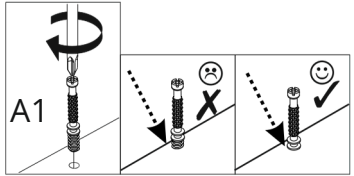
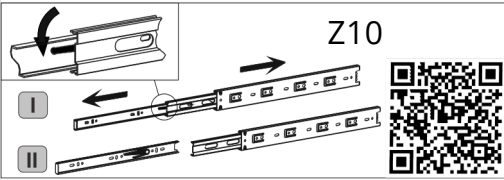
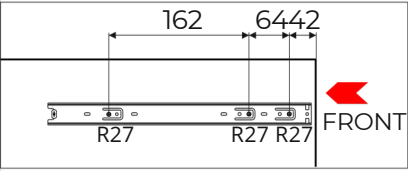
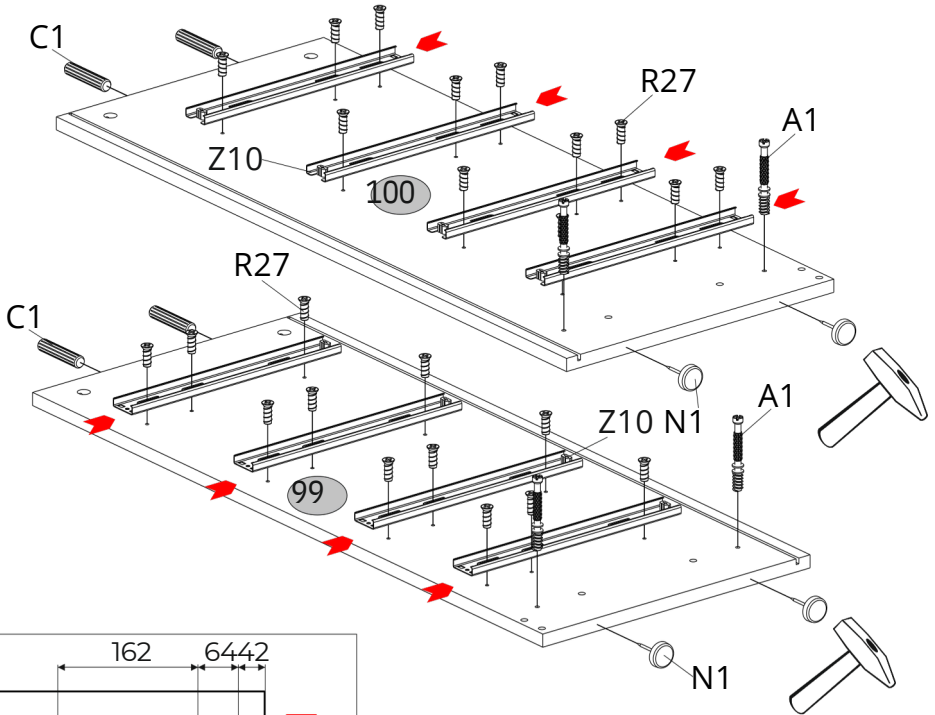
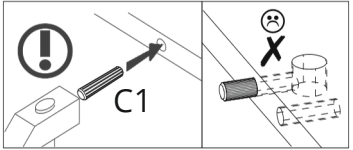

2

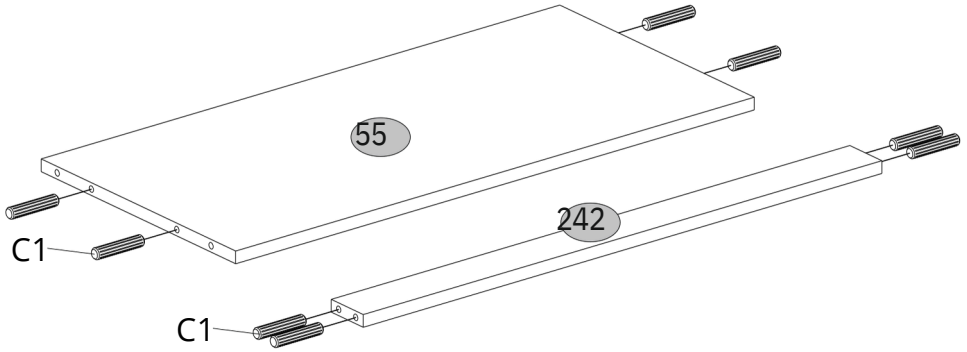
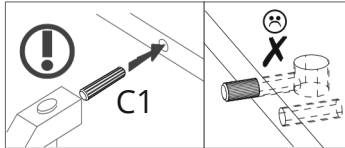
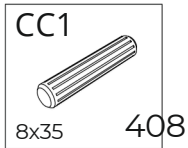

3

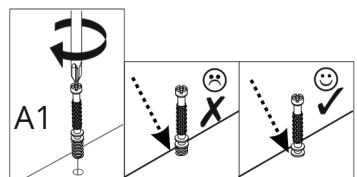
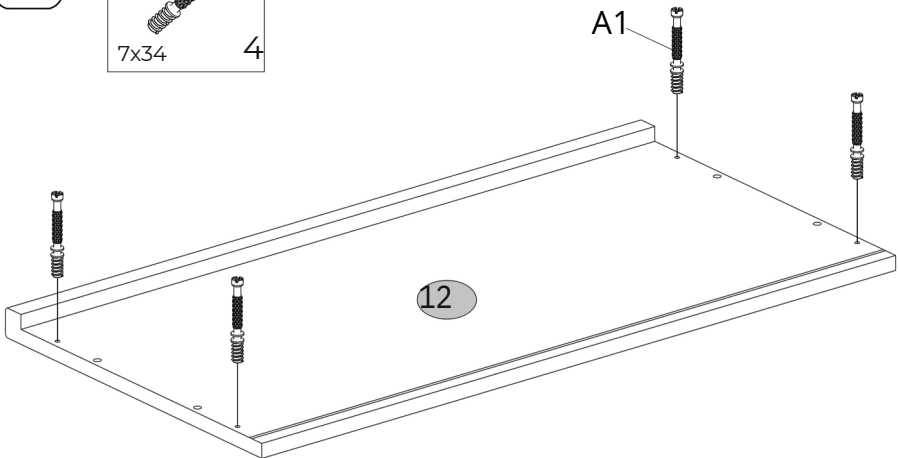
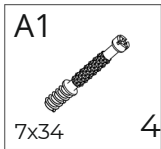

4

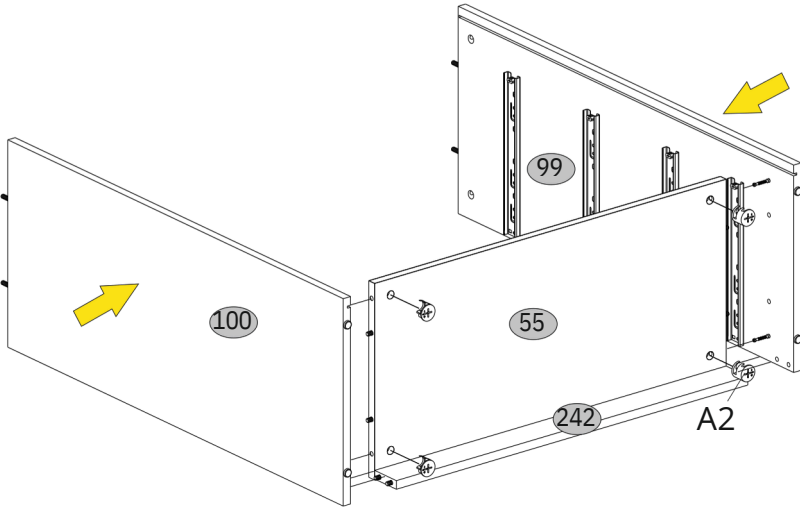
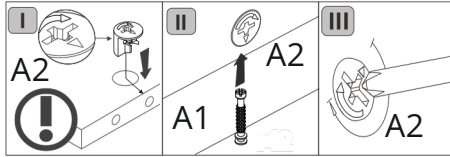
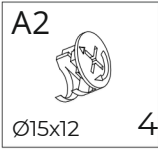

5

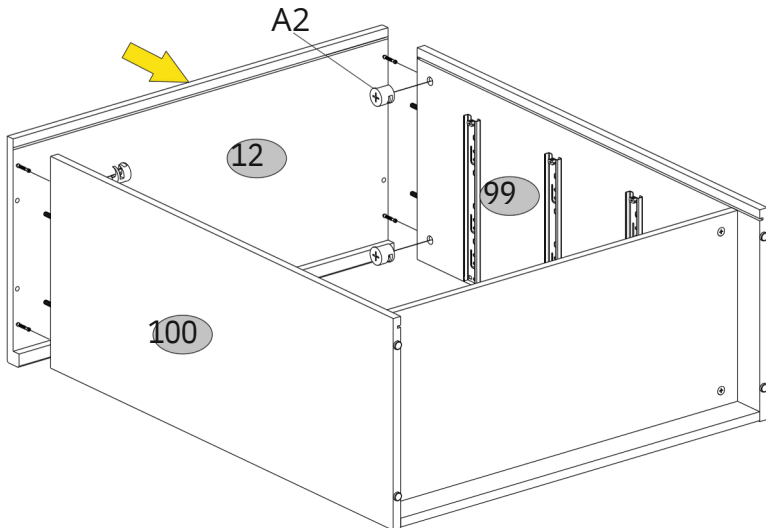
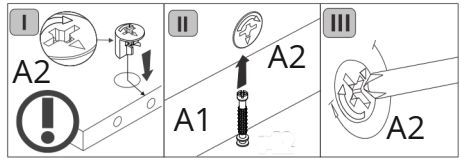
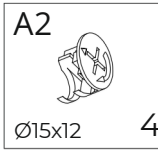

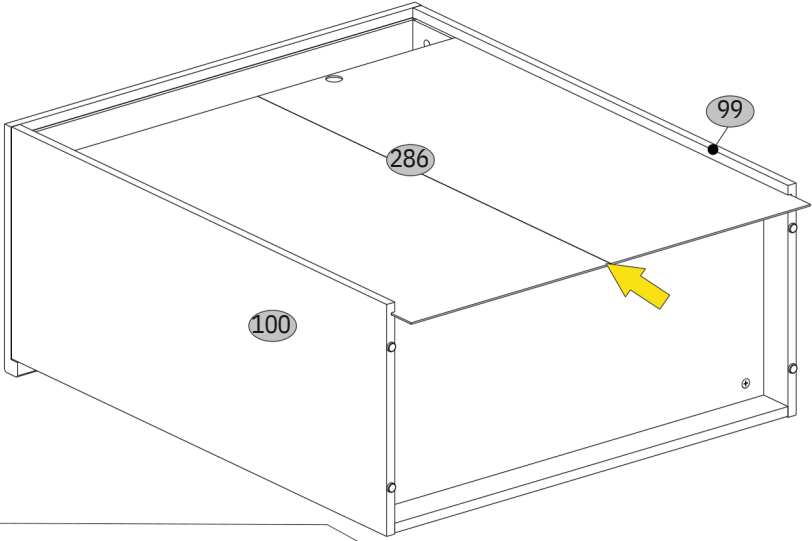

6

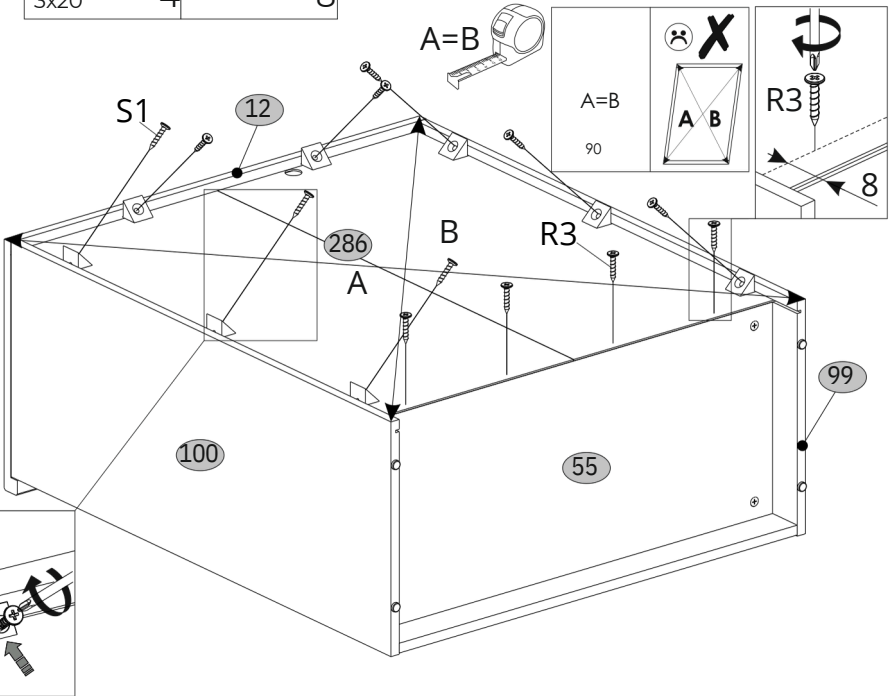
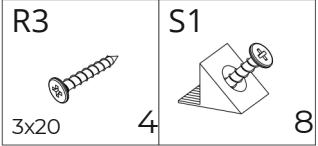

7





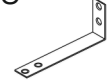

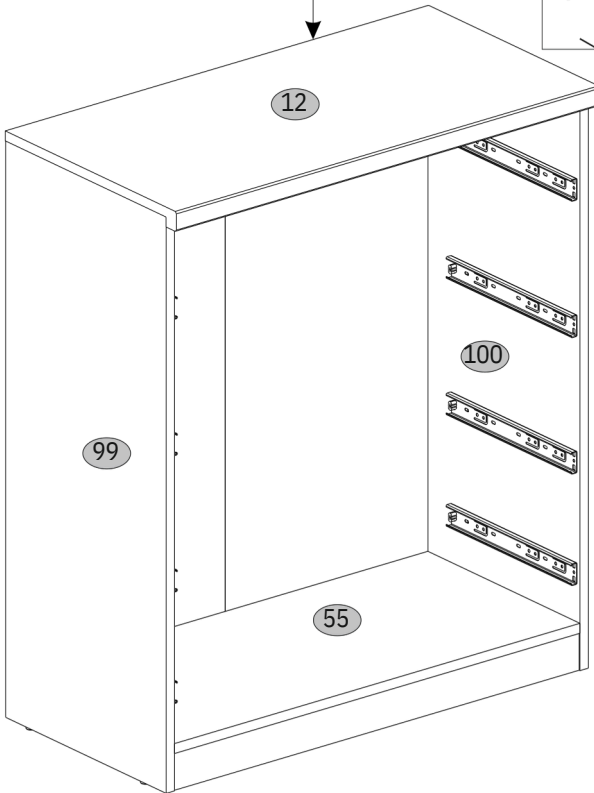
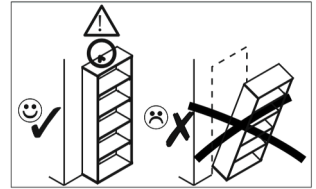
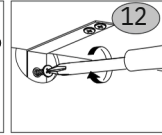
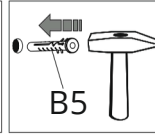
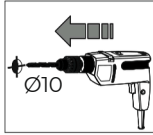
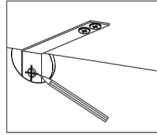
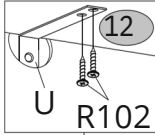



8

<b>B5</b>  10x50	<b>R102</b>  1 3,5x16	<b>U</b>  2 130x35x15
---	--	--

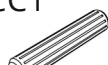

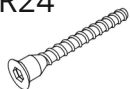

**9**  
x4

<b>A1</b>  7x34 16	<b>A2</b>  Ø15x12 16	<b>CC1</b>  8x35 4106	<b>I</b>  1	<b>H58</b>  4
<b>R24</b>  7x50 16	<b>R27</b>  5,0x13 16	<b>R32</b>  4x27 8	<b>S5</b>  Ø18 16	<b>Z10</b>  300 4

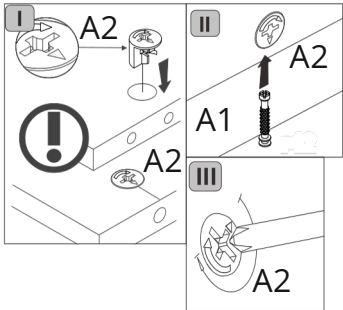
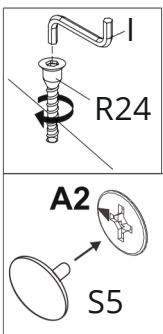
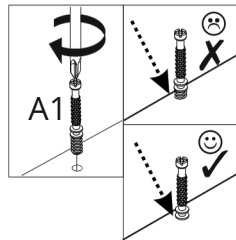
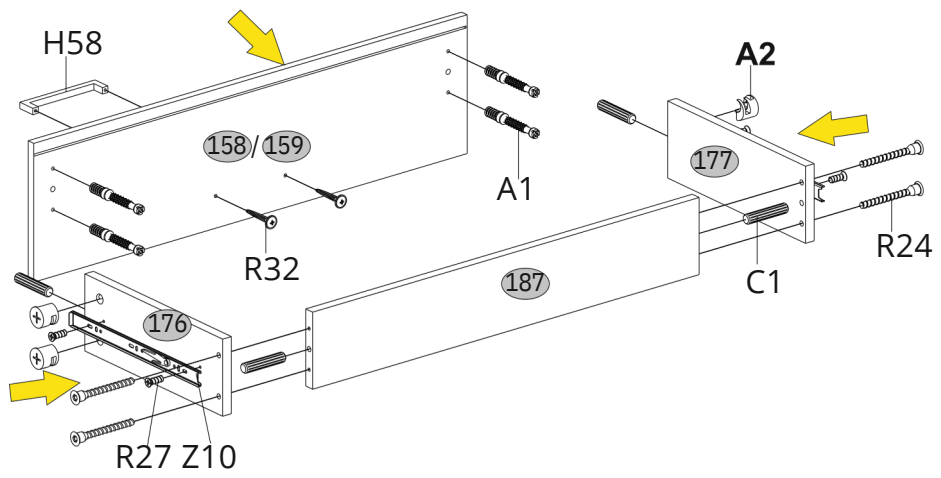
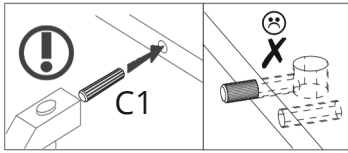
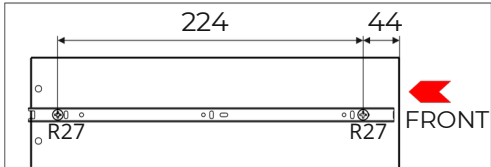

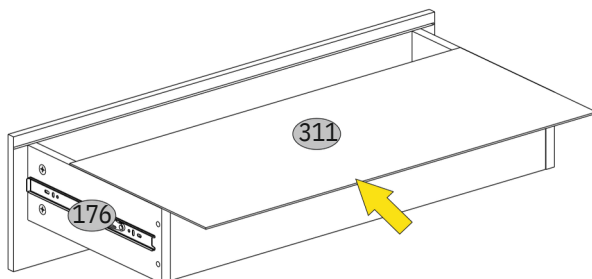

10

x4



11

x4

L1	R3	R102
		
320	4	40
	3x20	3,5x16
		8

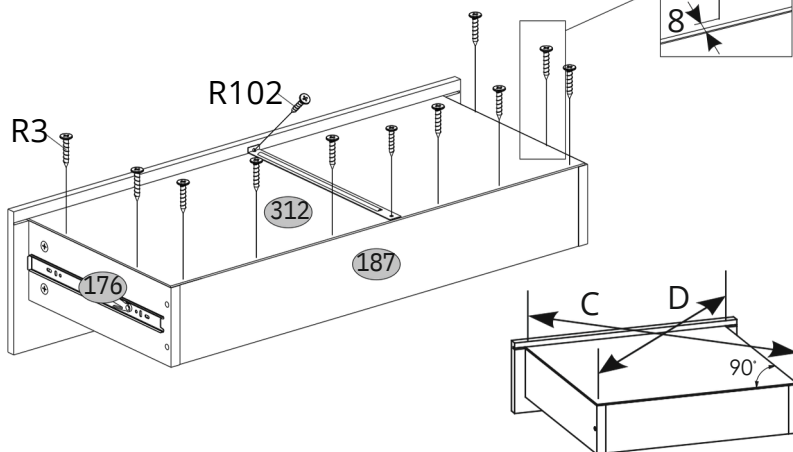

12

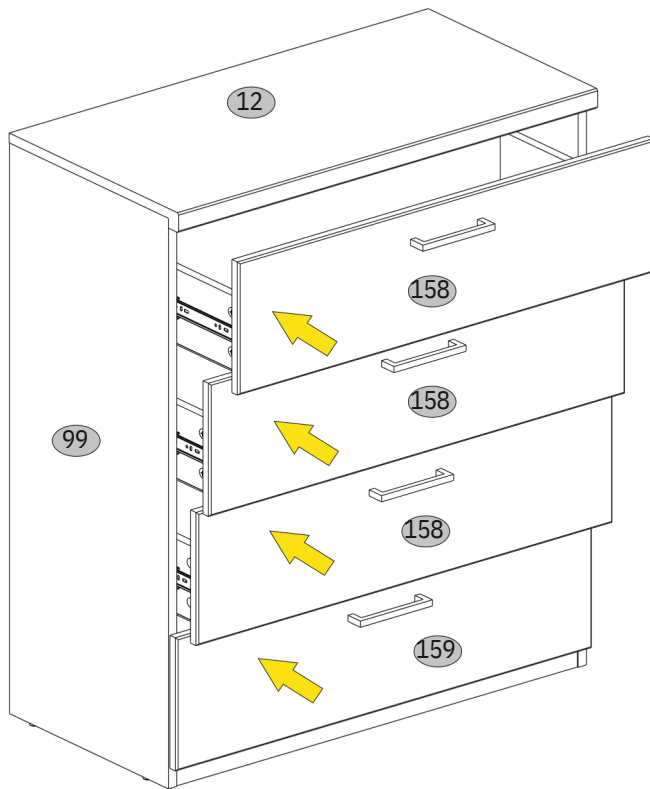

12 158 159 max. 5 kg