

4x ZP3590 ZC0	3x UK394128S U1	4x 4x27 WP4	28x 3,5x16 WP5	2x MB12/12 M2	2x OM000015X O1	2x 4,2x32 WP8		
20x ZS020863F ZN1	8x 3,5x16 W3	15x WS000001X ST1	1 kpl. PK35300G PK3	4x ZS014863F ZN2	15x 3x20 W9	4x PH200001R PR2	4x 4x25 WP3	4x ST025505B N1
4x 6,4x50 K5	20x 8x30 K1	2x DU645 T2	1x K20	24x MB15/15 M1	24x DU232T T1	7x KH000002X KH1	14x 2x20 G1	8x 5x11 E1

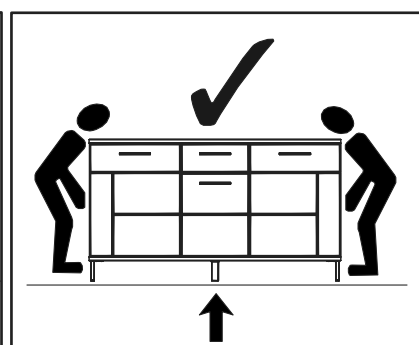

10

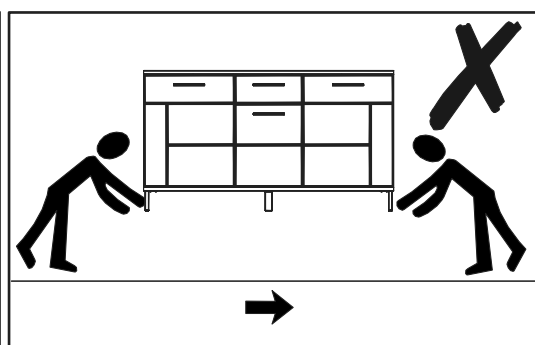
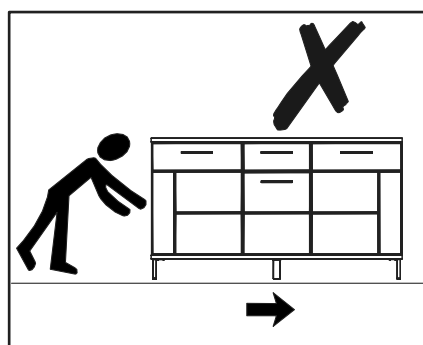
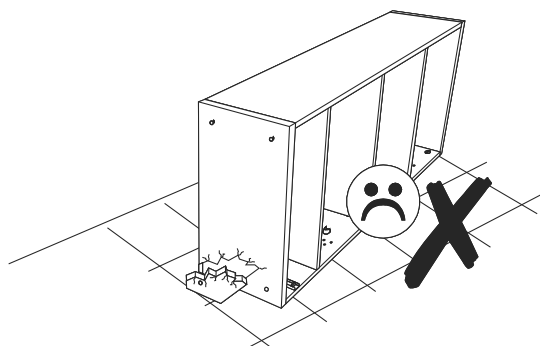
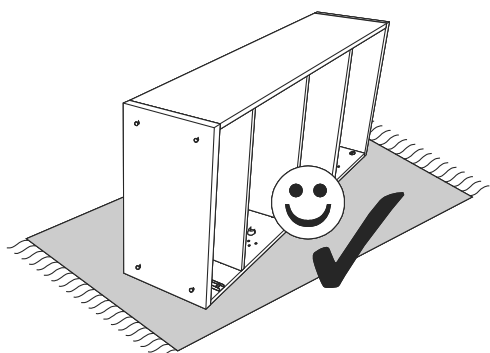
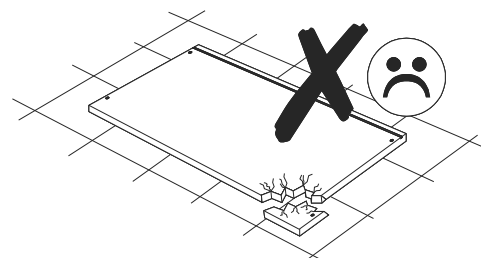
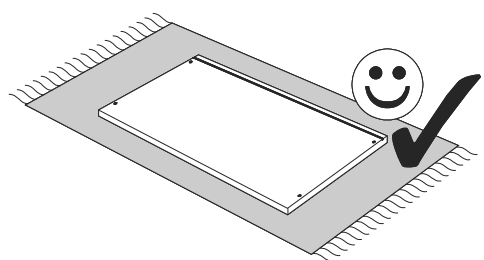
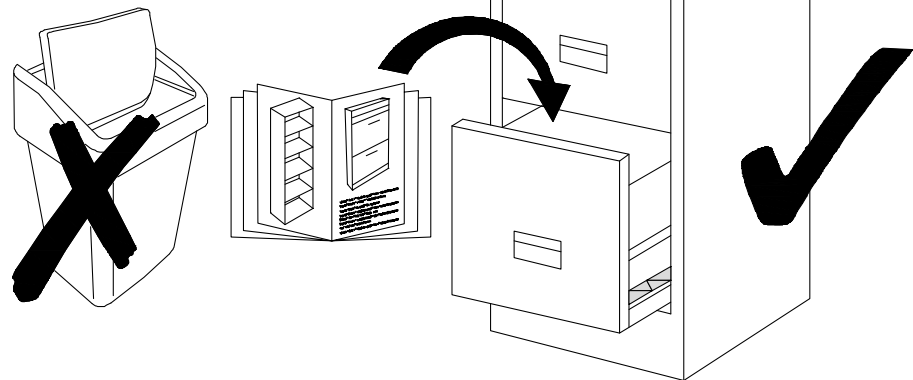
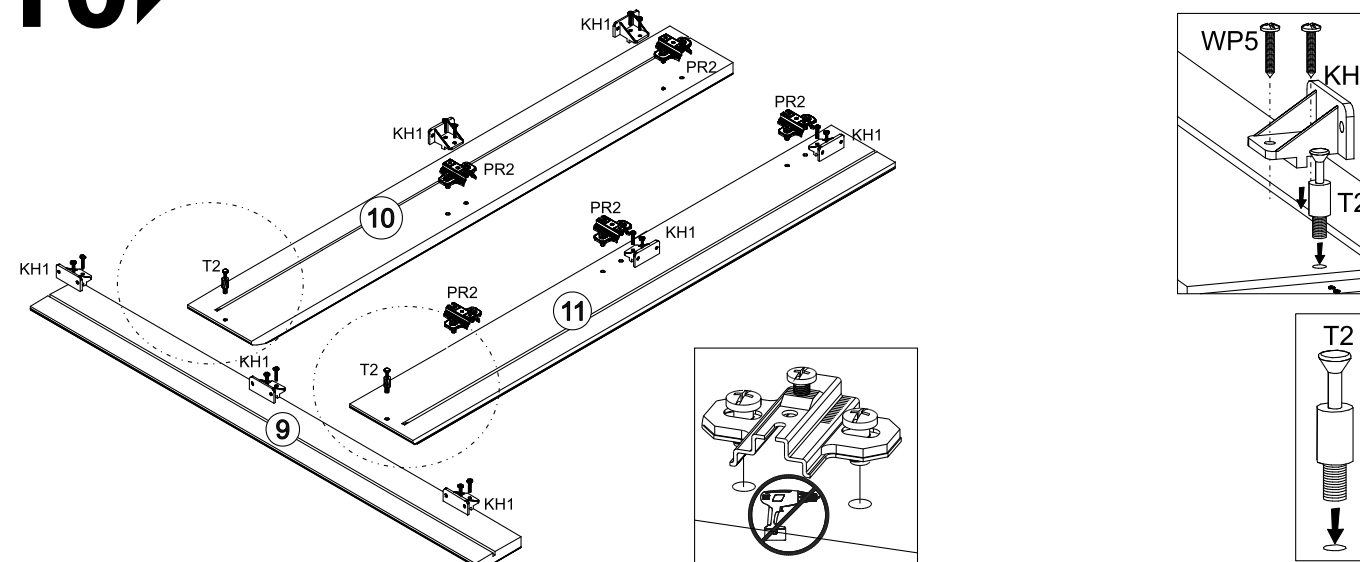

11

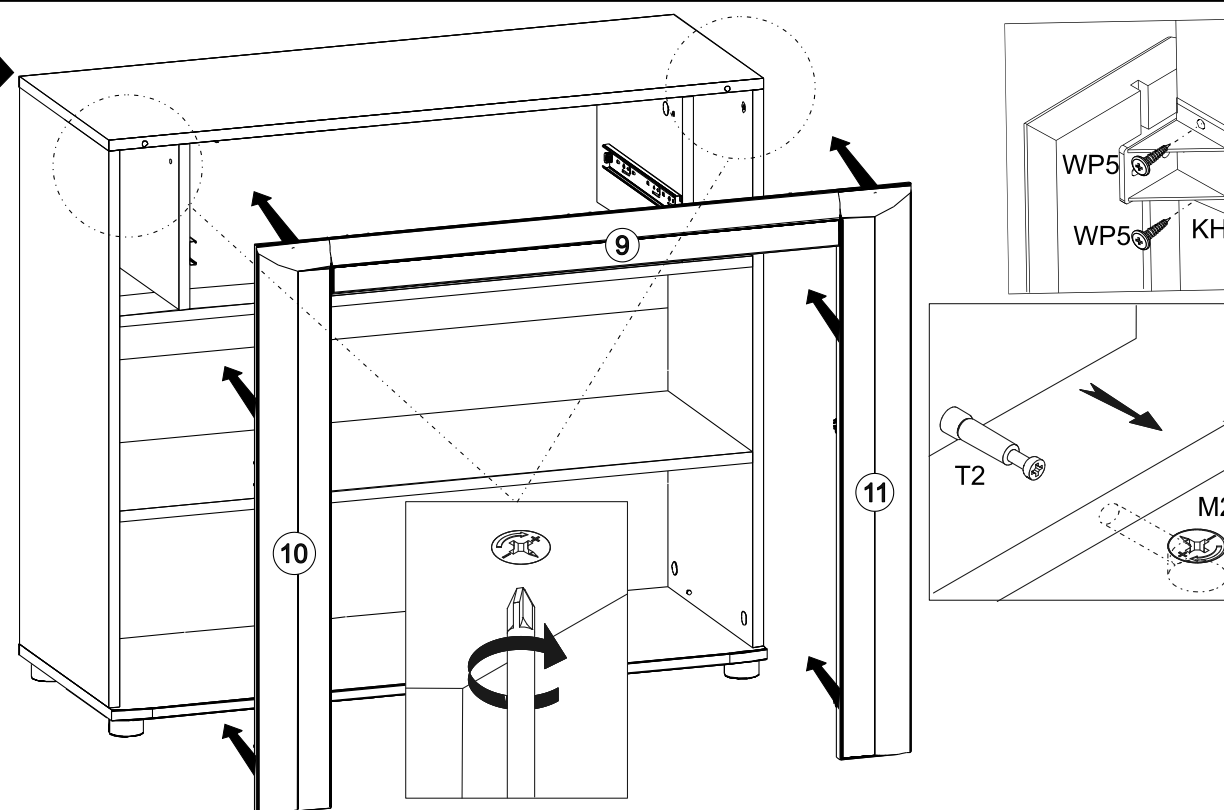

12

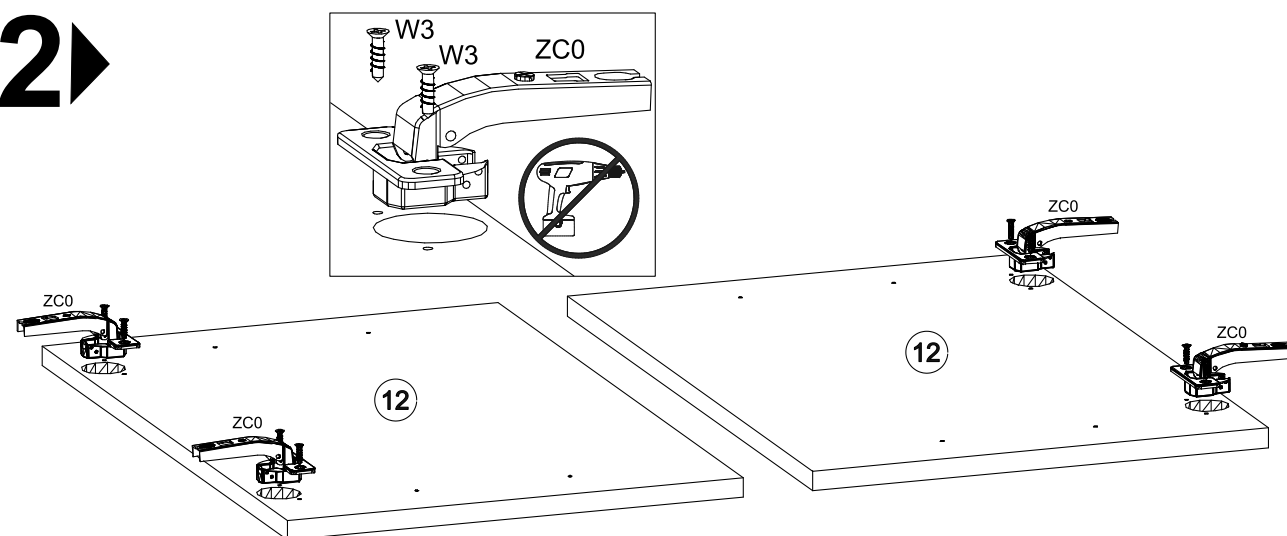

8

BT02

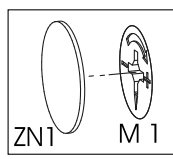
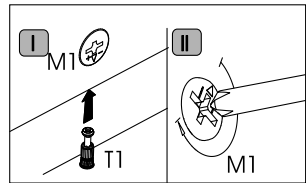
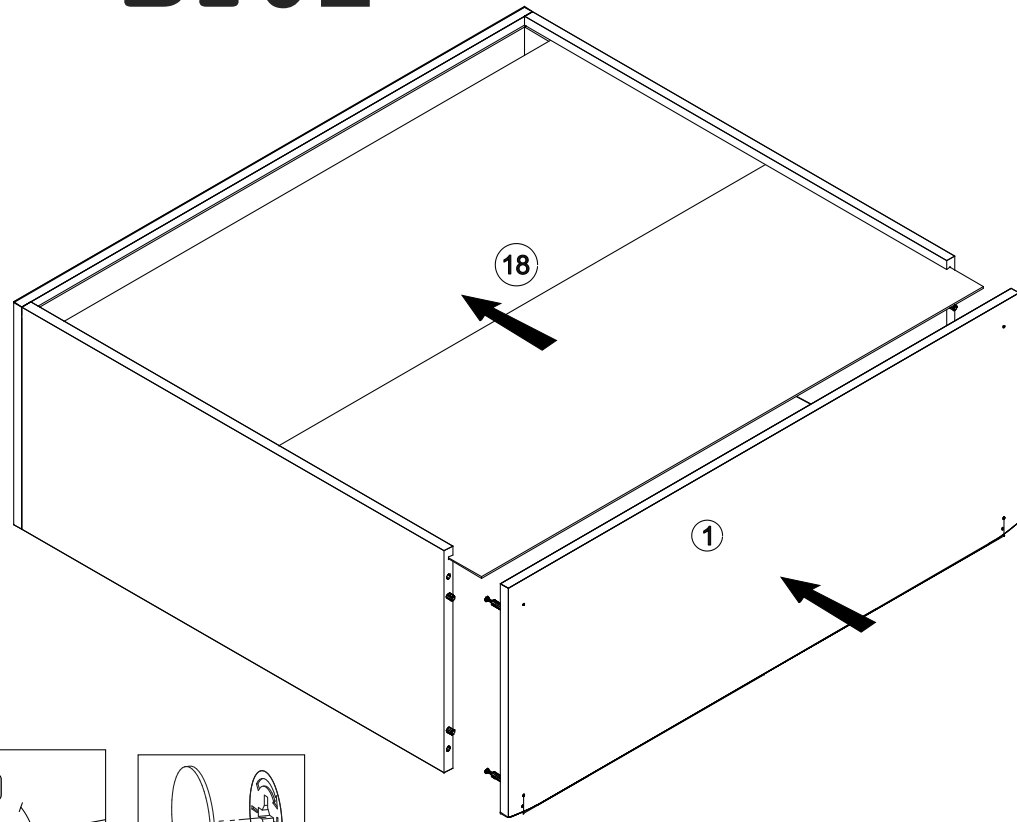

9

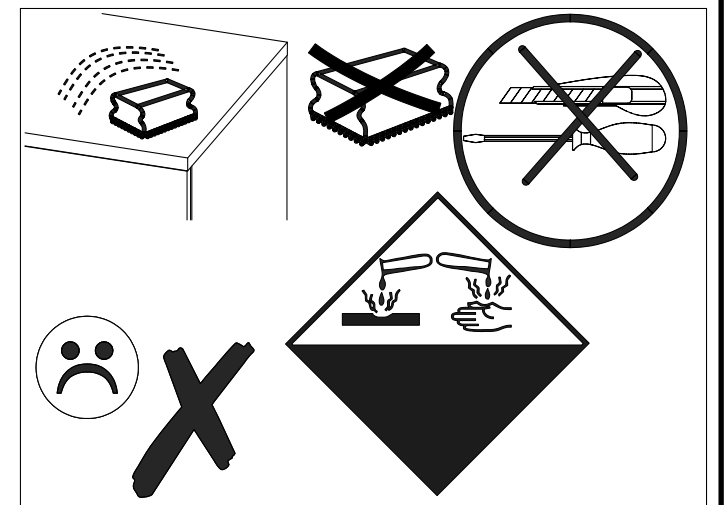
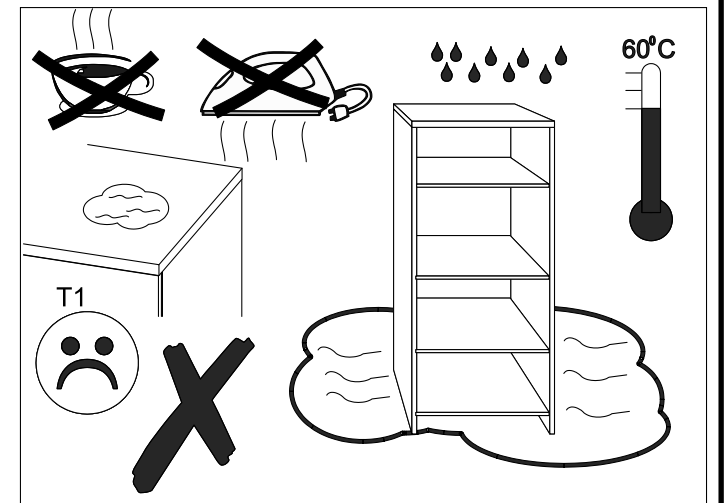
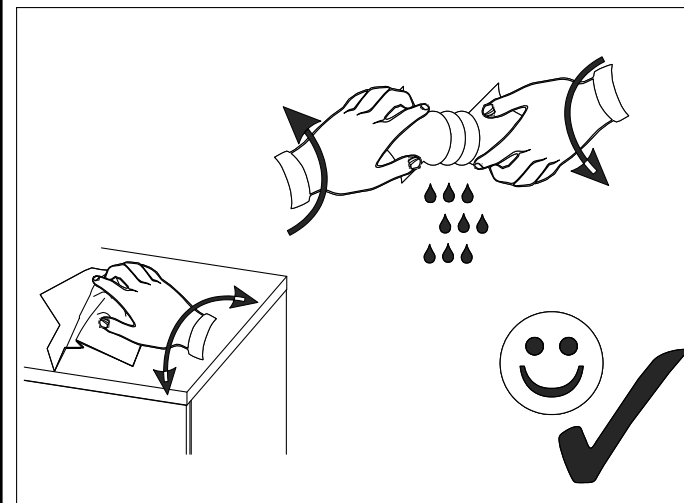
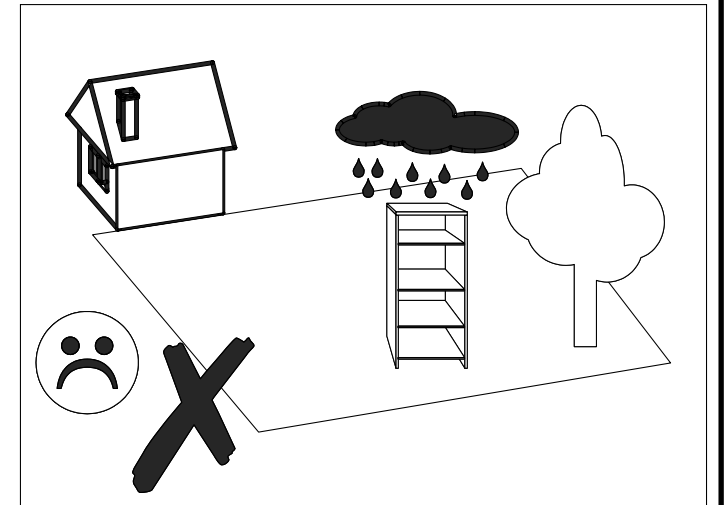
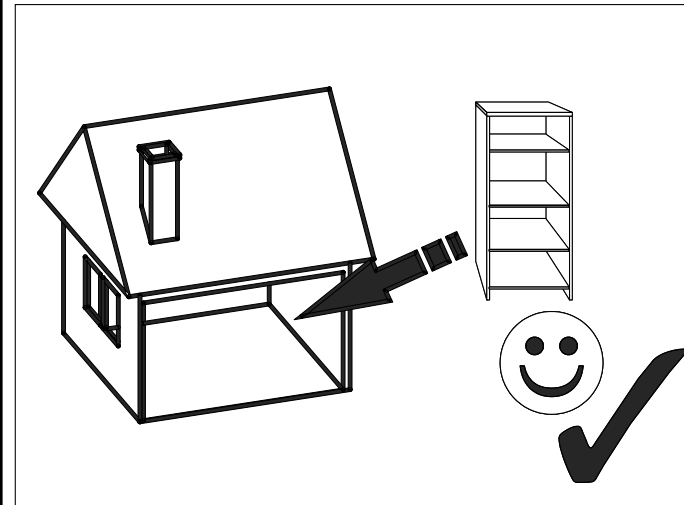
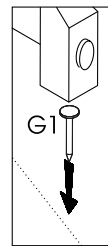
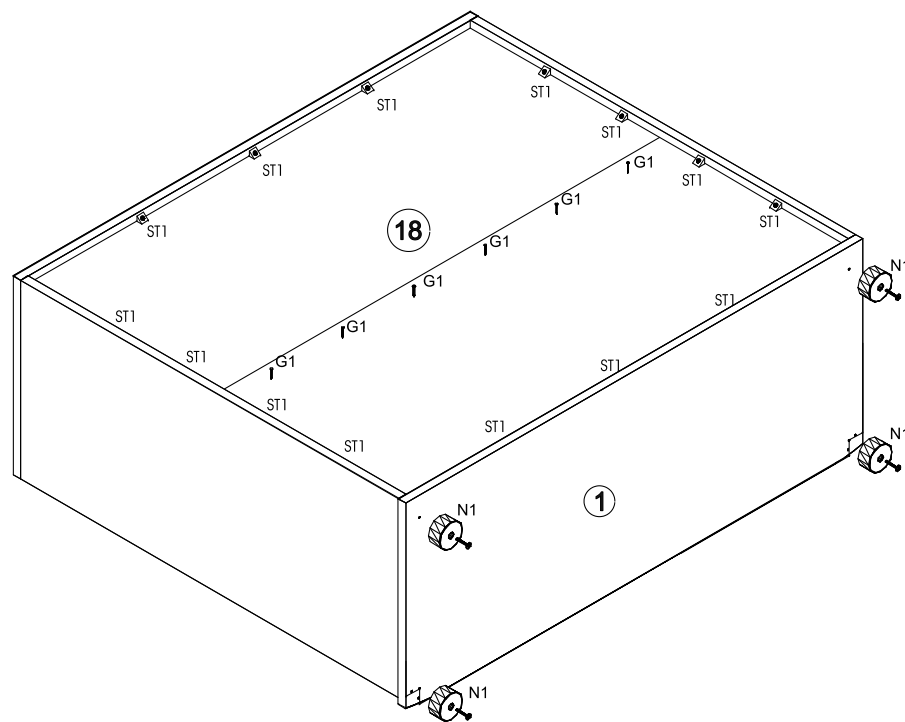
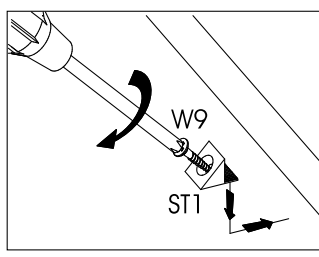
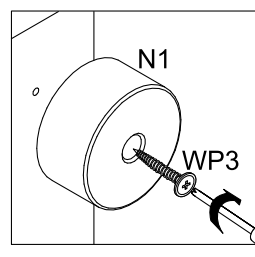
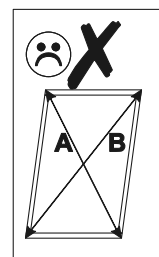
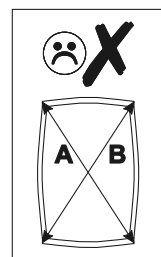
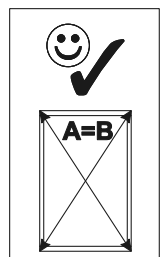

1 ▶

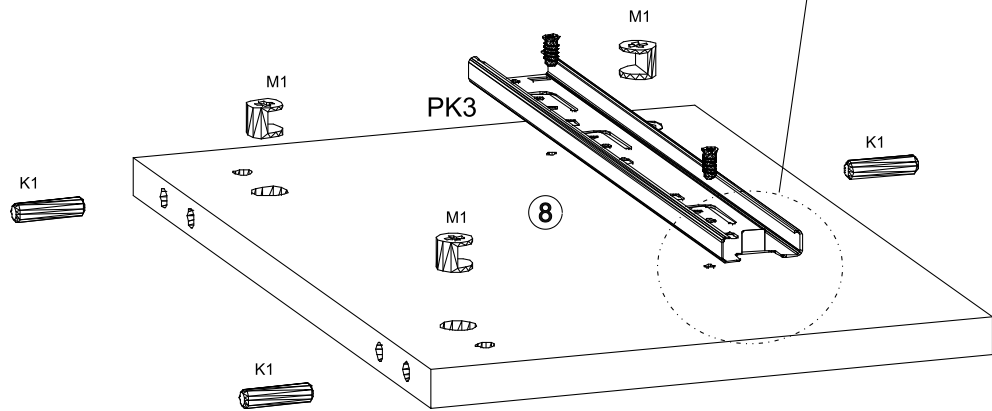
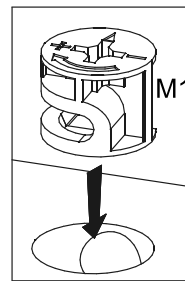
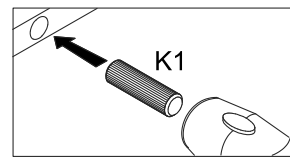
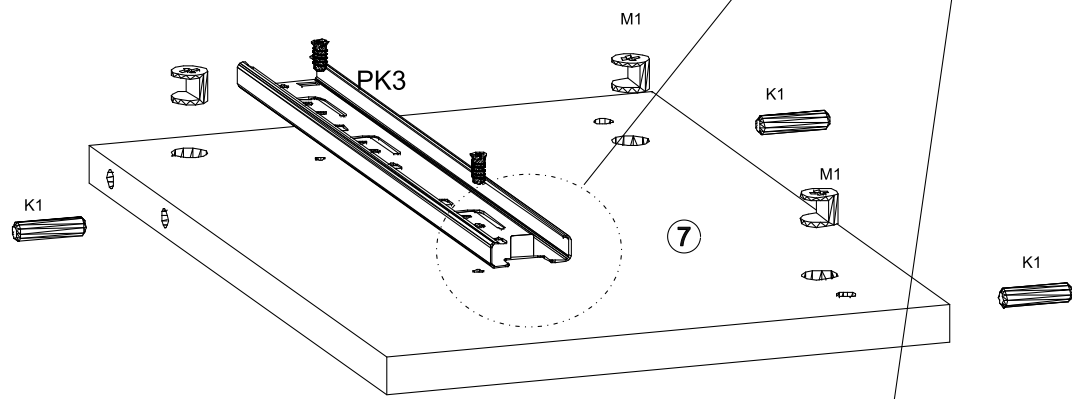
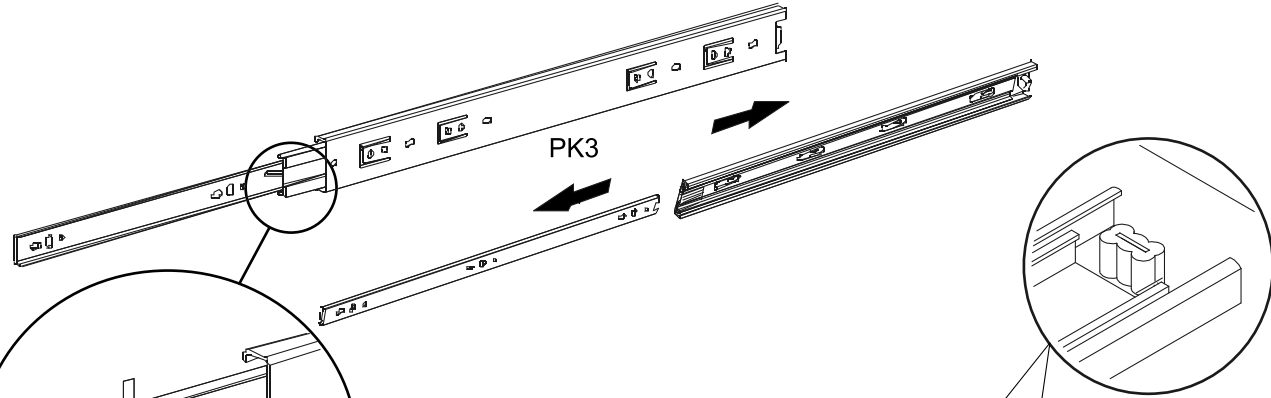
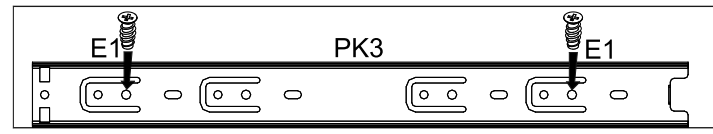

6 ▶

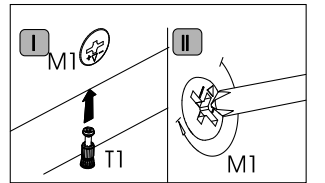
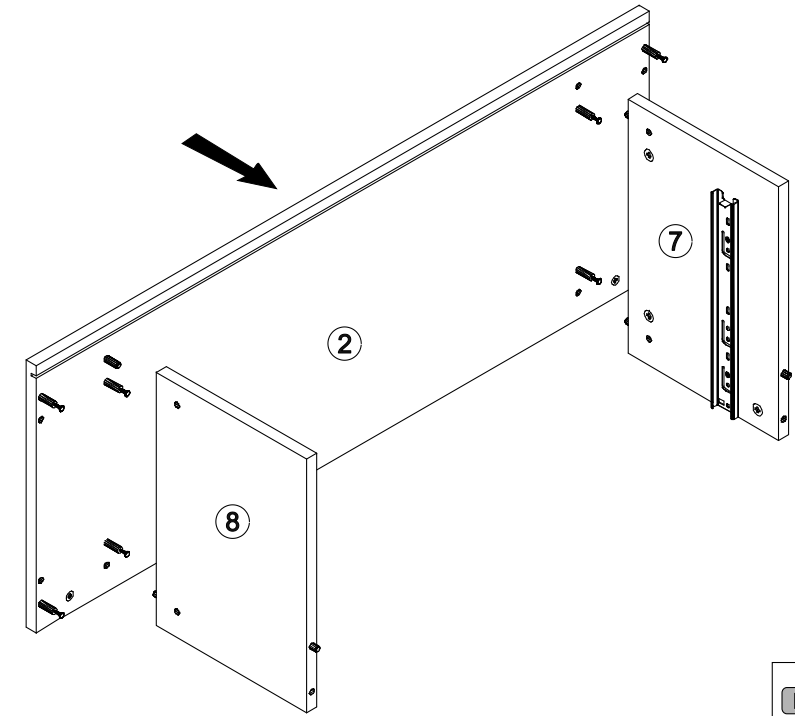

7 ▶

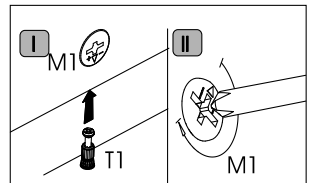
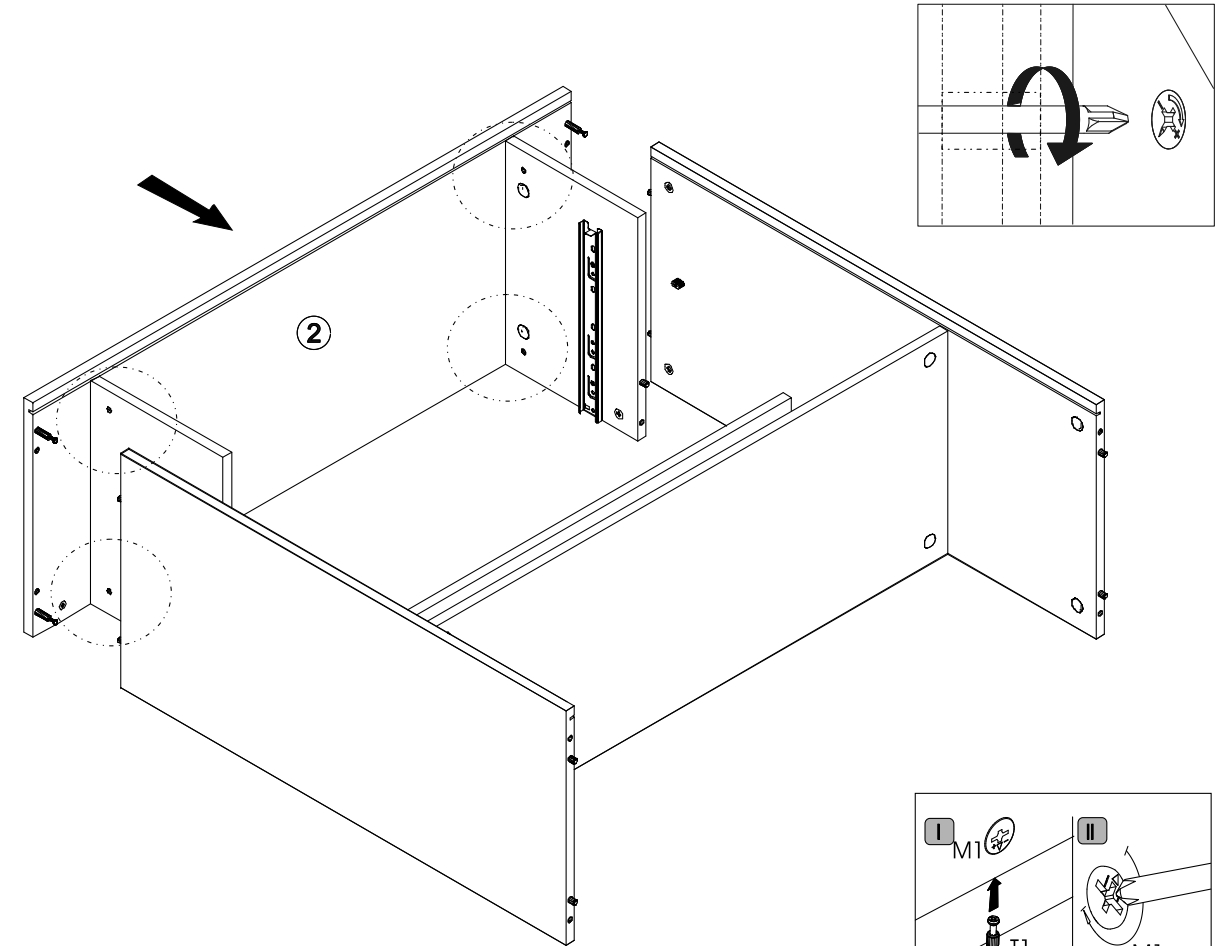

2

BT02

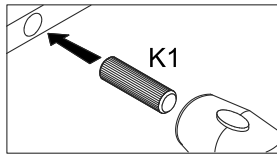
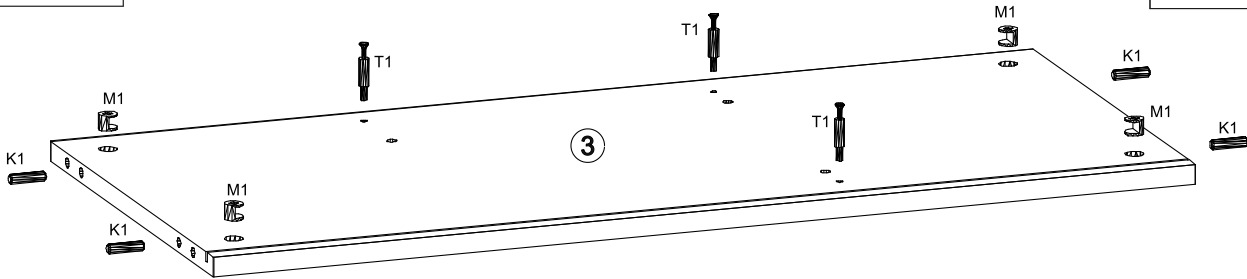
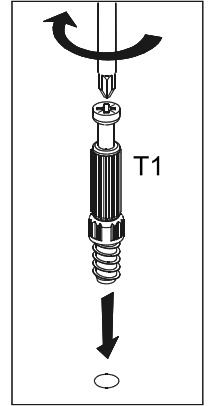
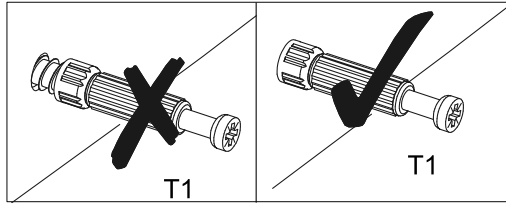
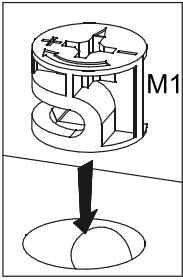

3

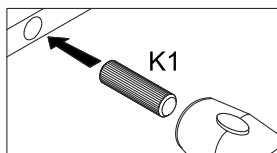
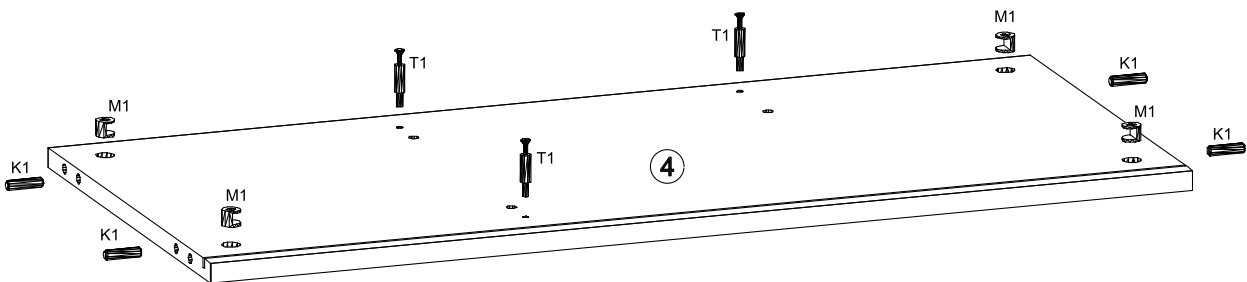
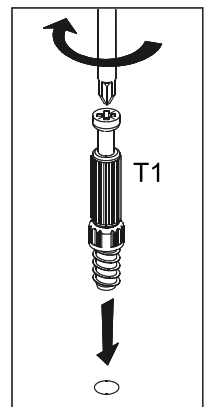
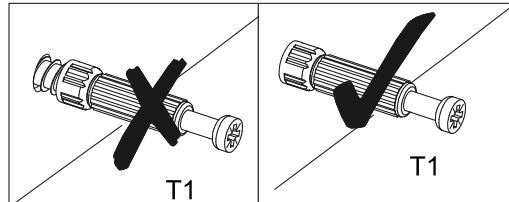
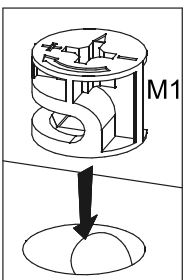

4

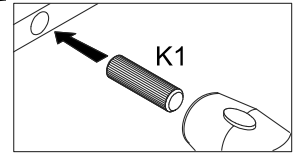
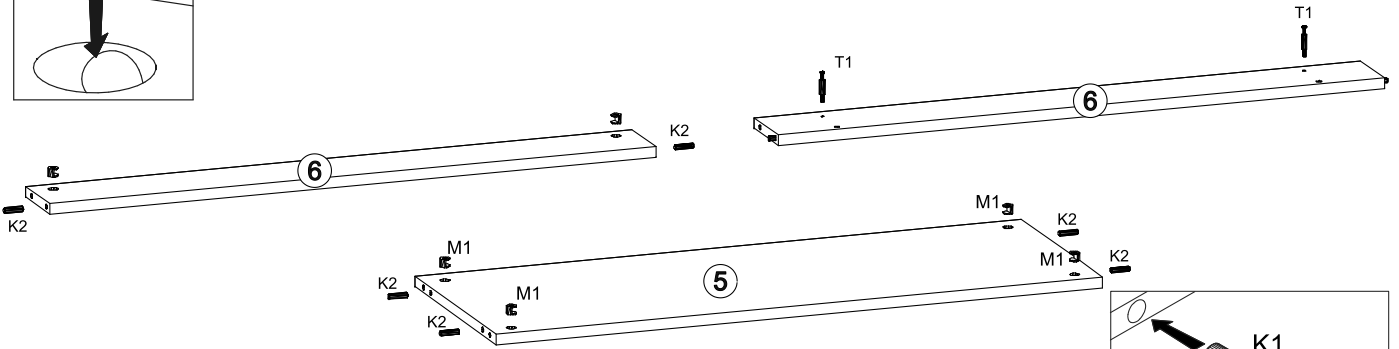
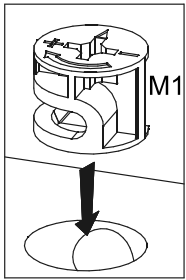
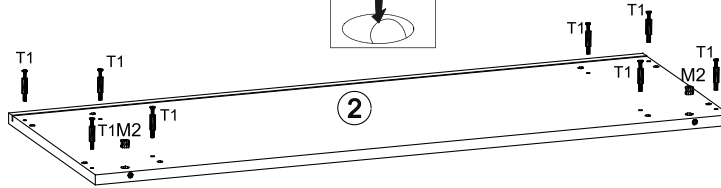
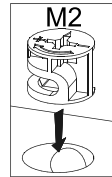
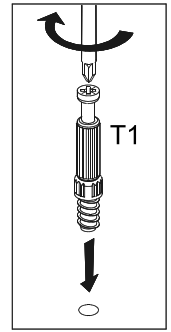
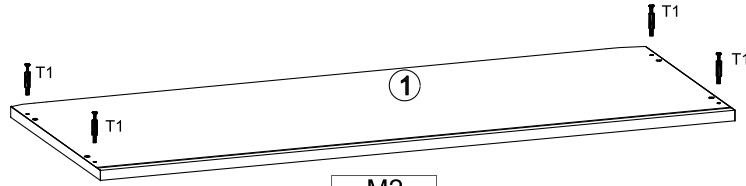
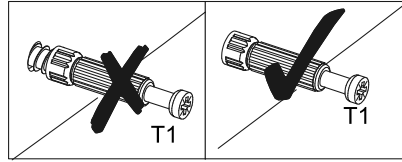

5

