

# SANTI/ SICILIA

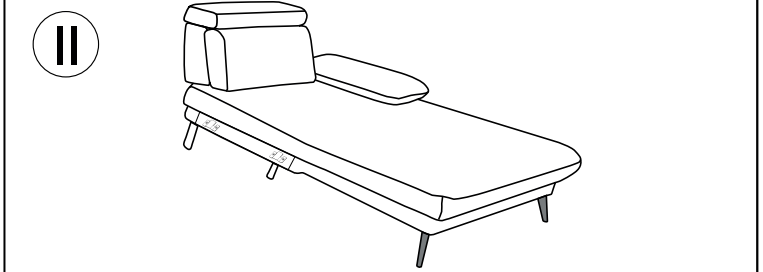

H=150 mm

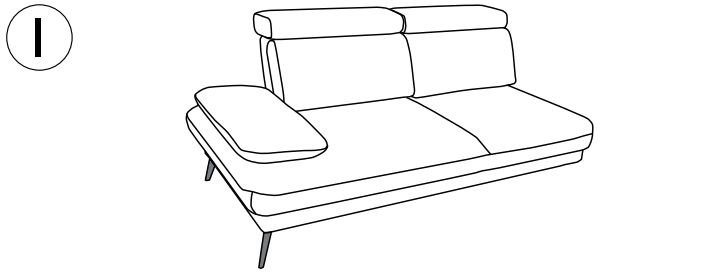
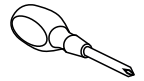
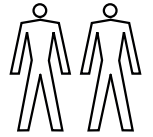
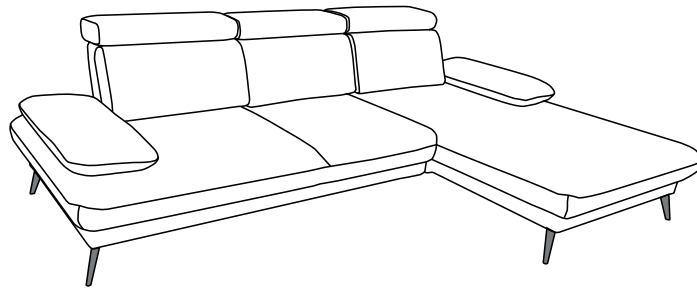
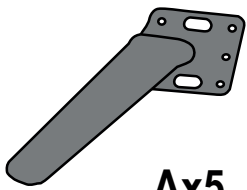

Ax5

H=160 mm



Bx1

M6x25

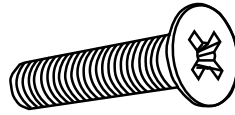

Cx10

Ø6 mm



Dx10

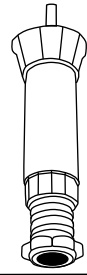

Ex1

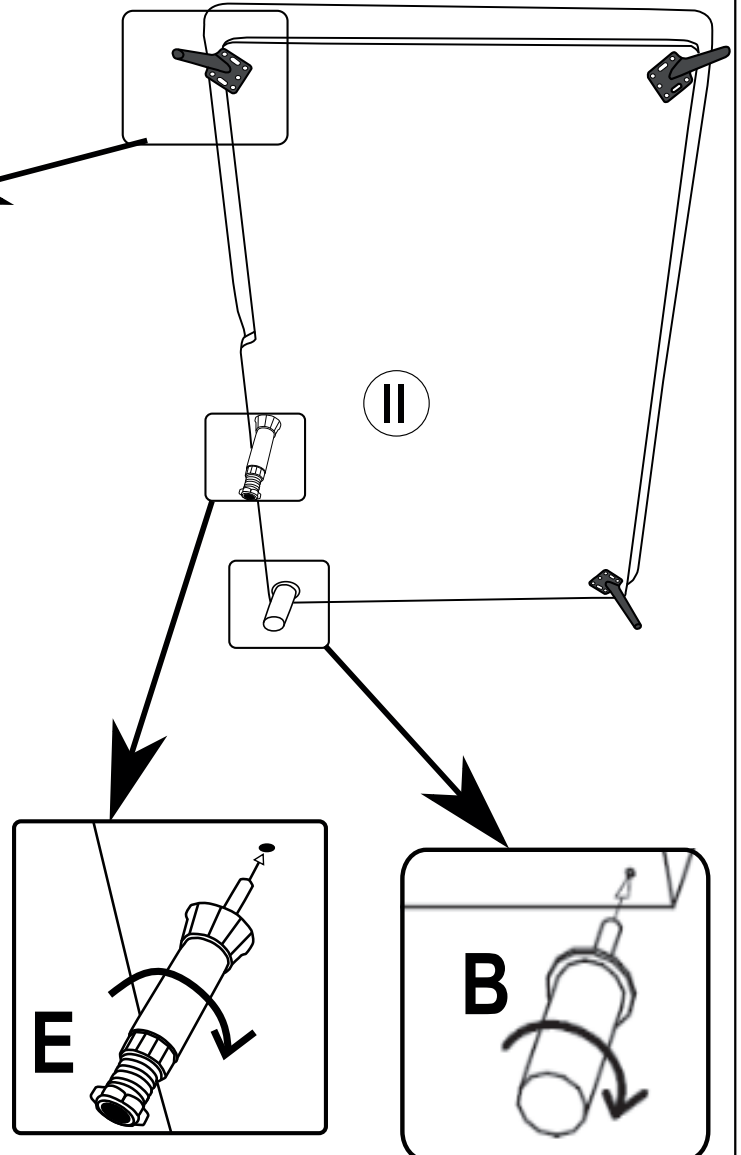
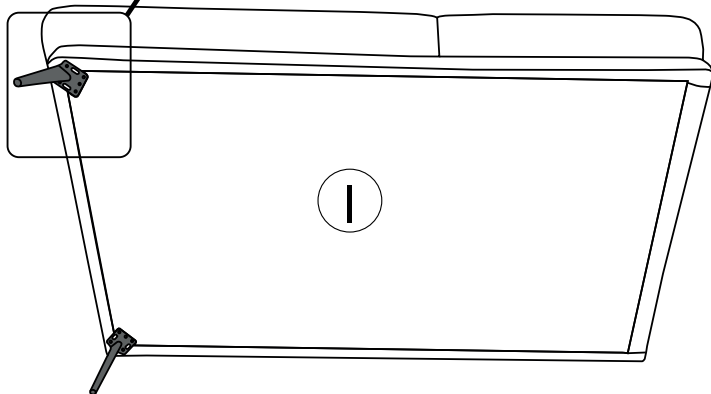
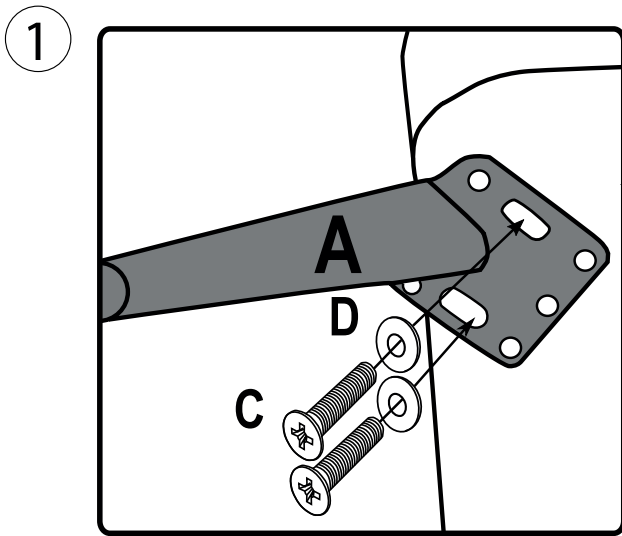

# SANTI/ SICILIA

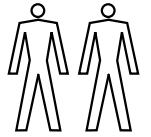
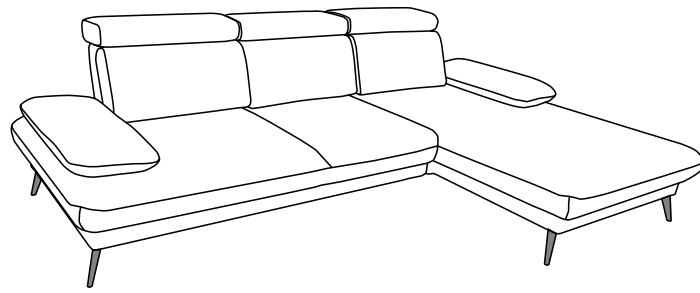

2

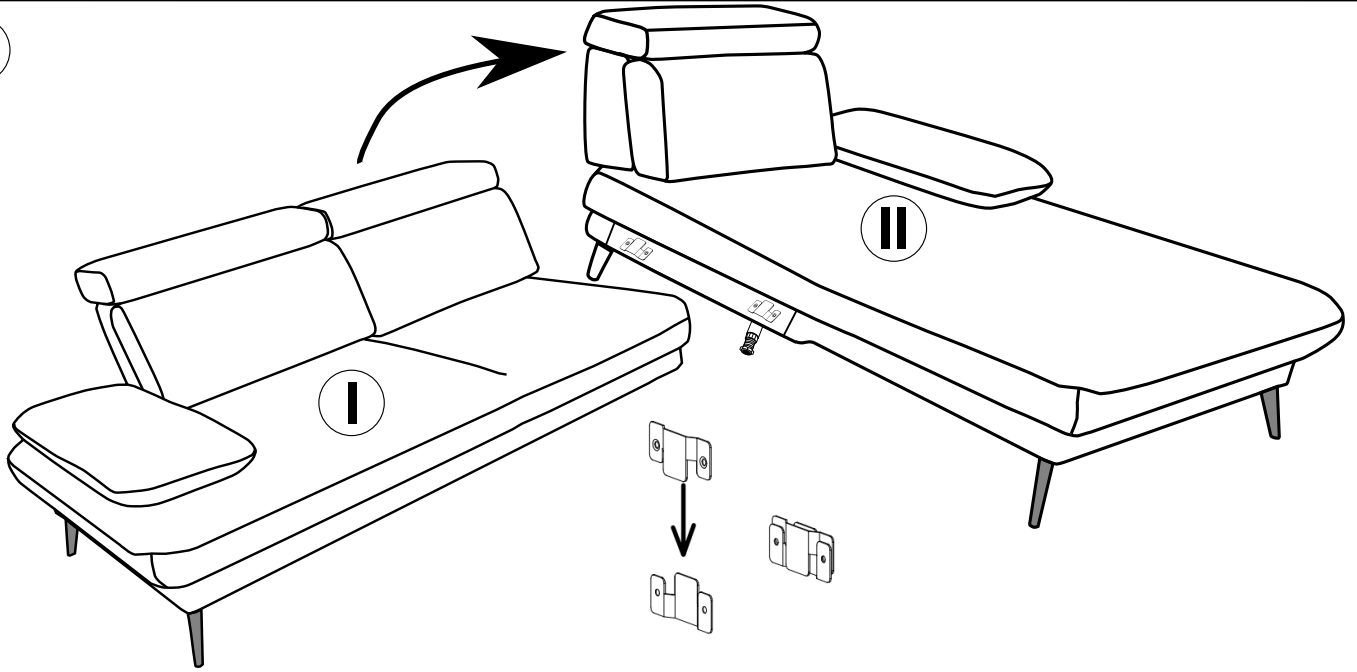

3

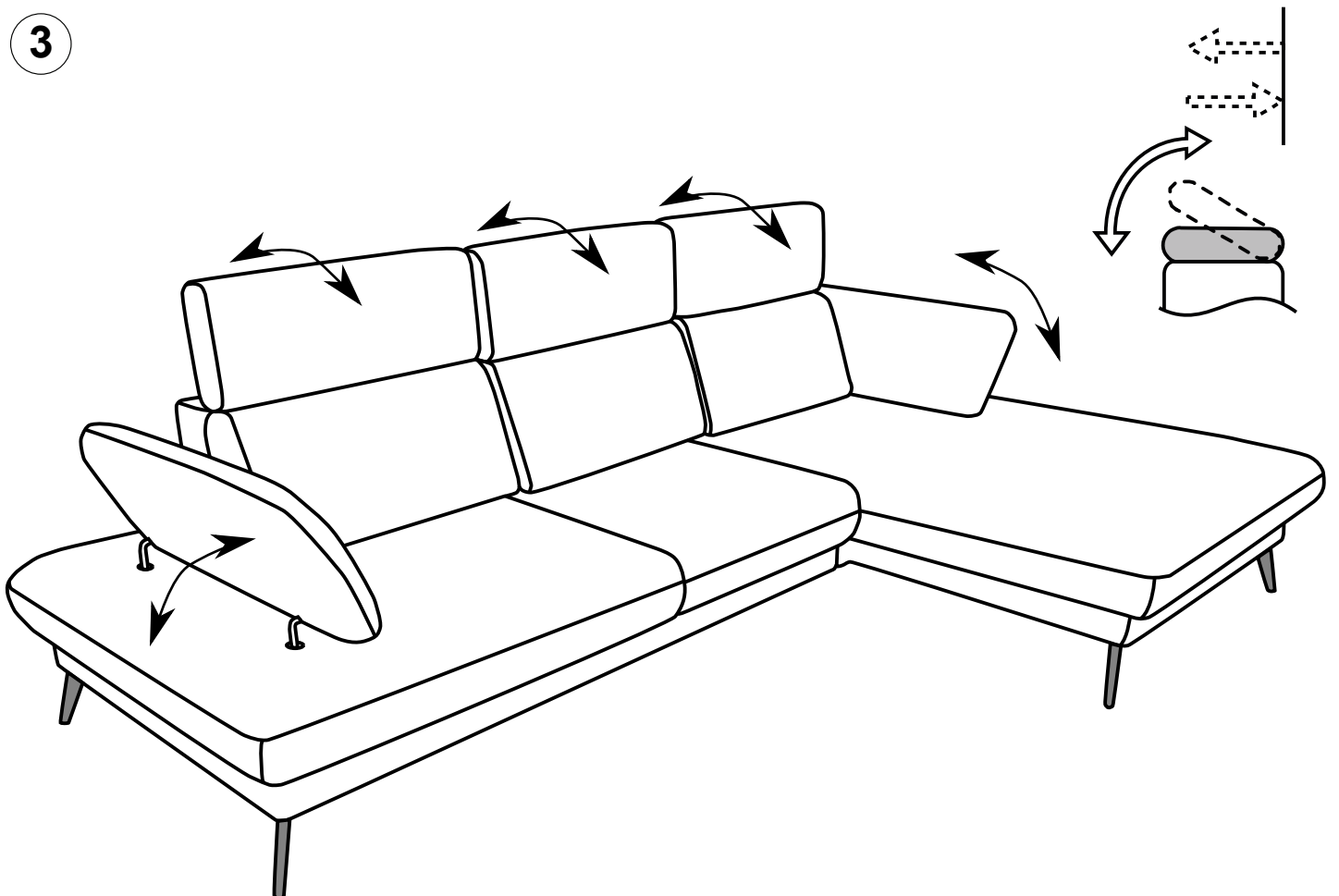

# SANTI/ SICILIA

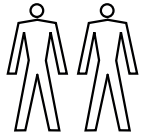
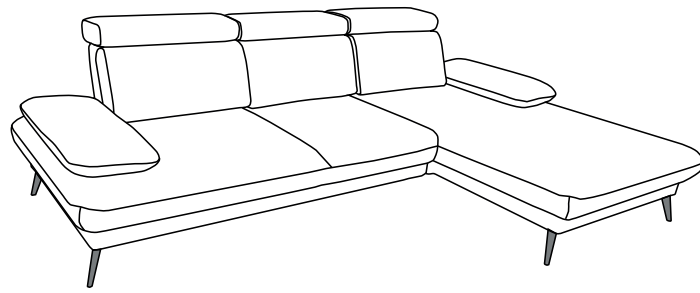

4

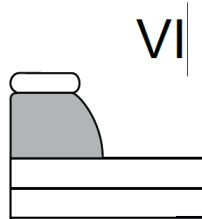
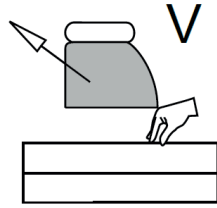
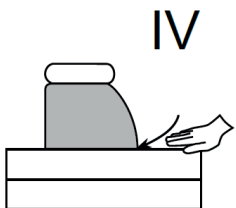
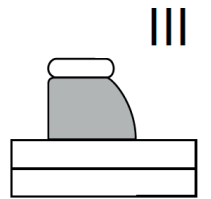
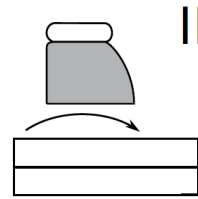
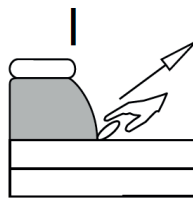
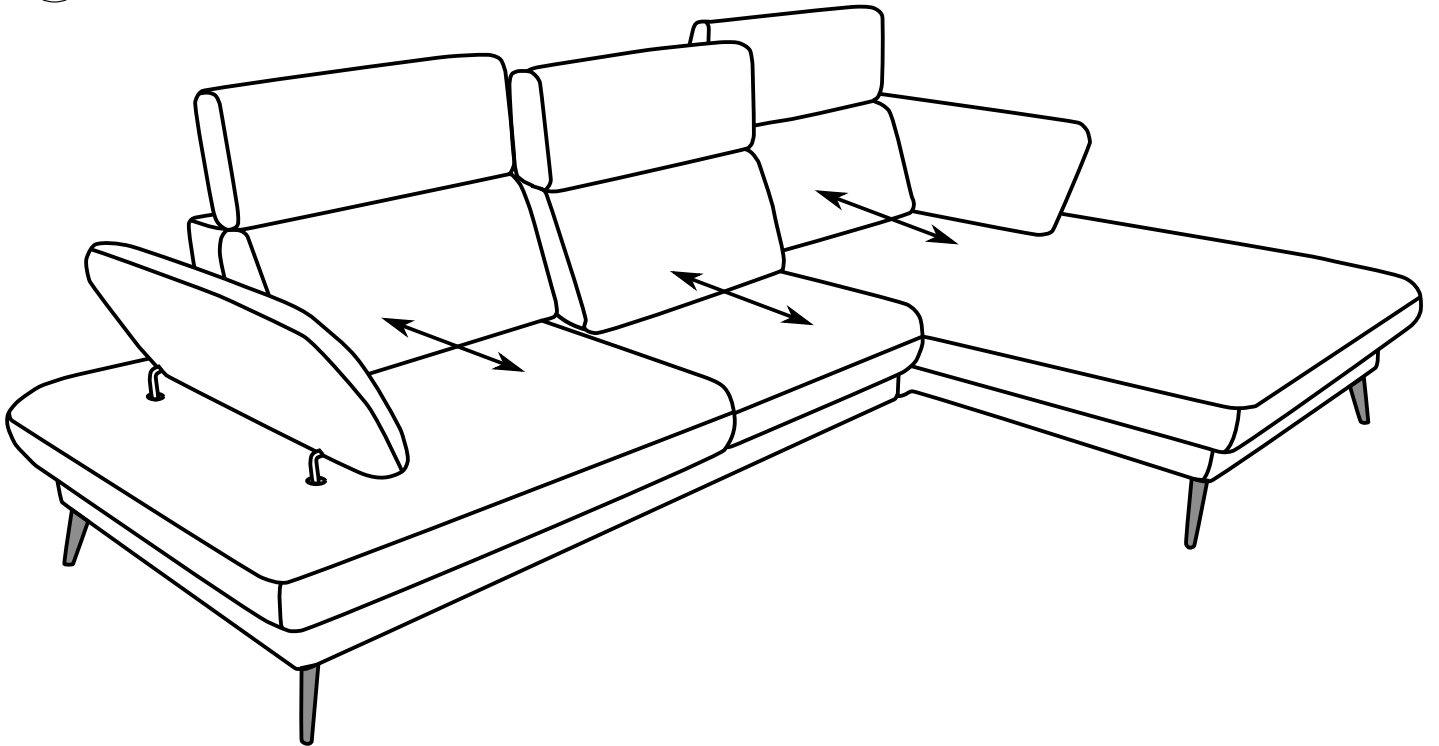

# SANTI/ SICILIA

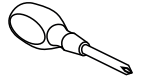
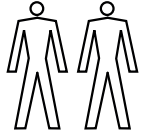
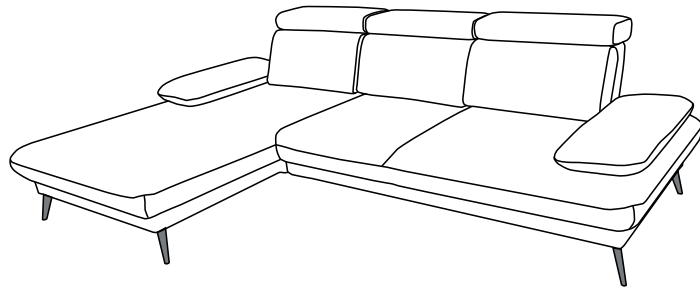

I

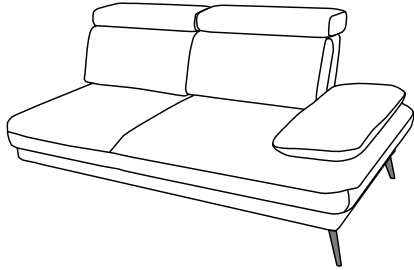

II

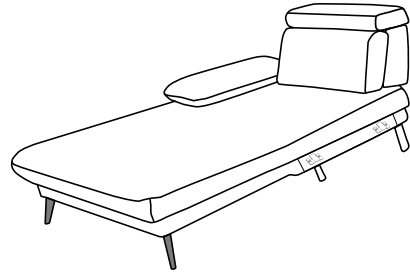

H=150 mm

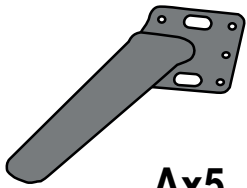

Ax5

H=160 mm



Bx1

M6x25

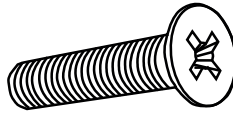

Cx10

Ø6 mm



Dx10

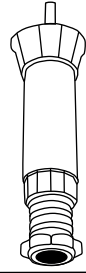

Ex1

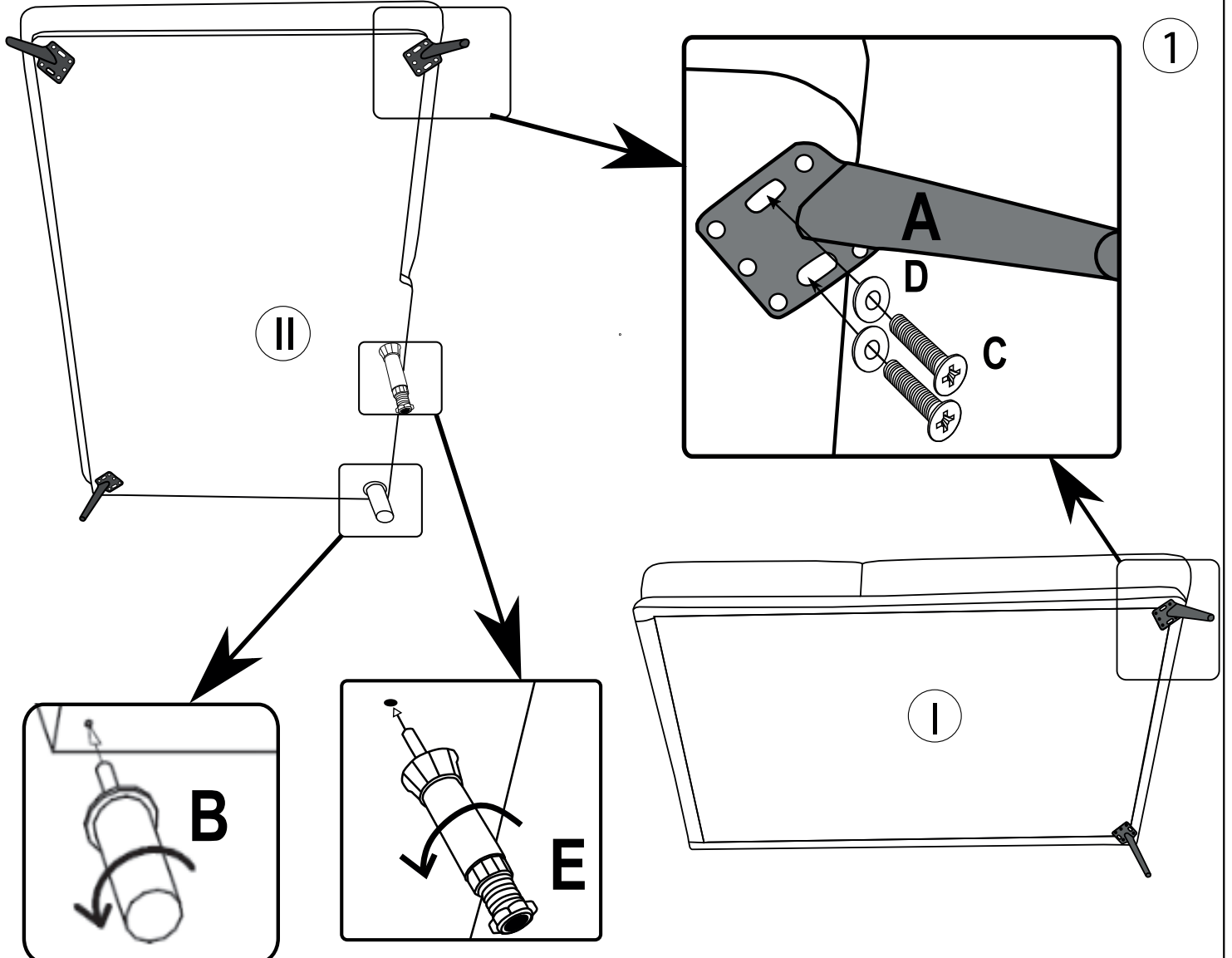

# SANTI/ SICILIA

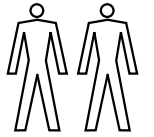
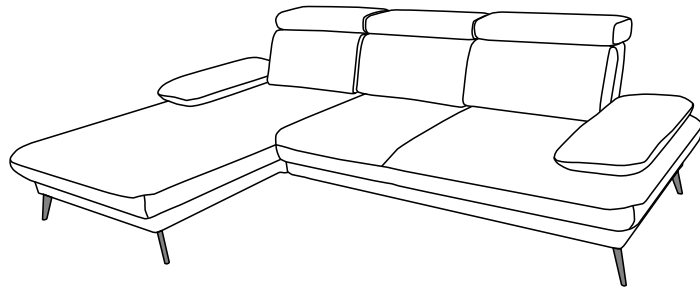

2

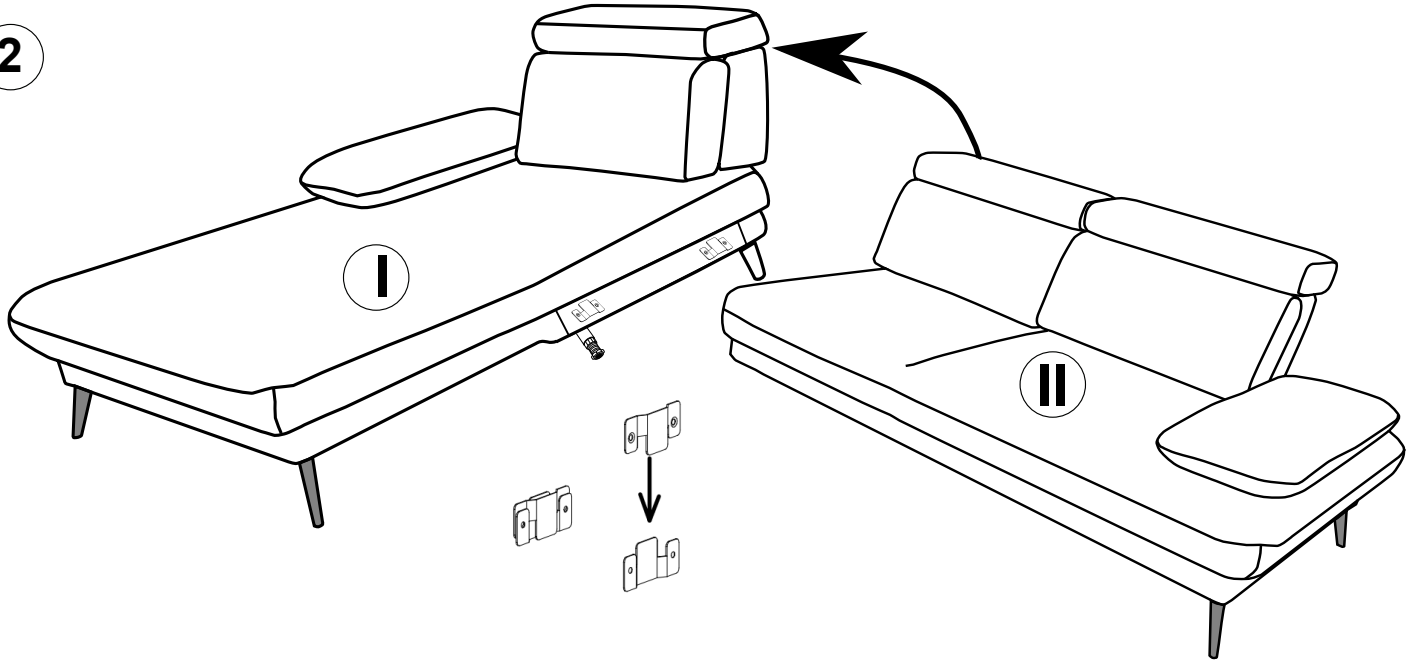

3

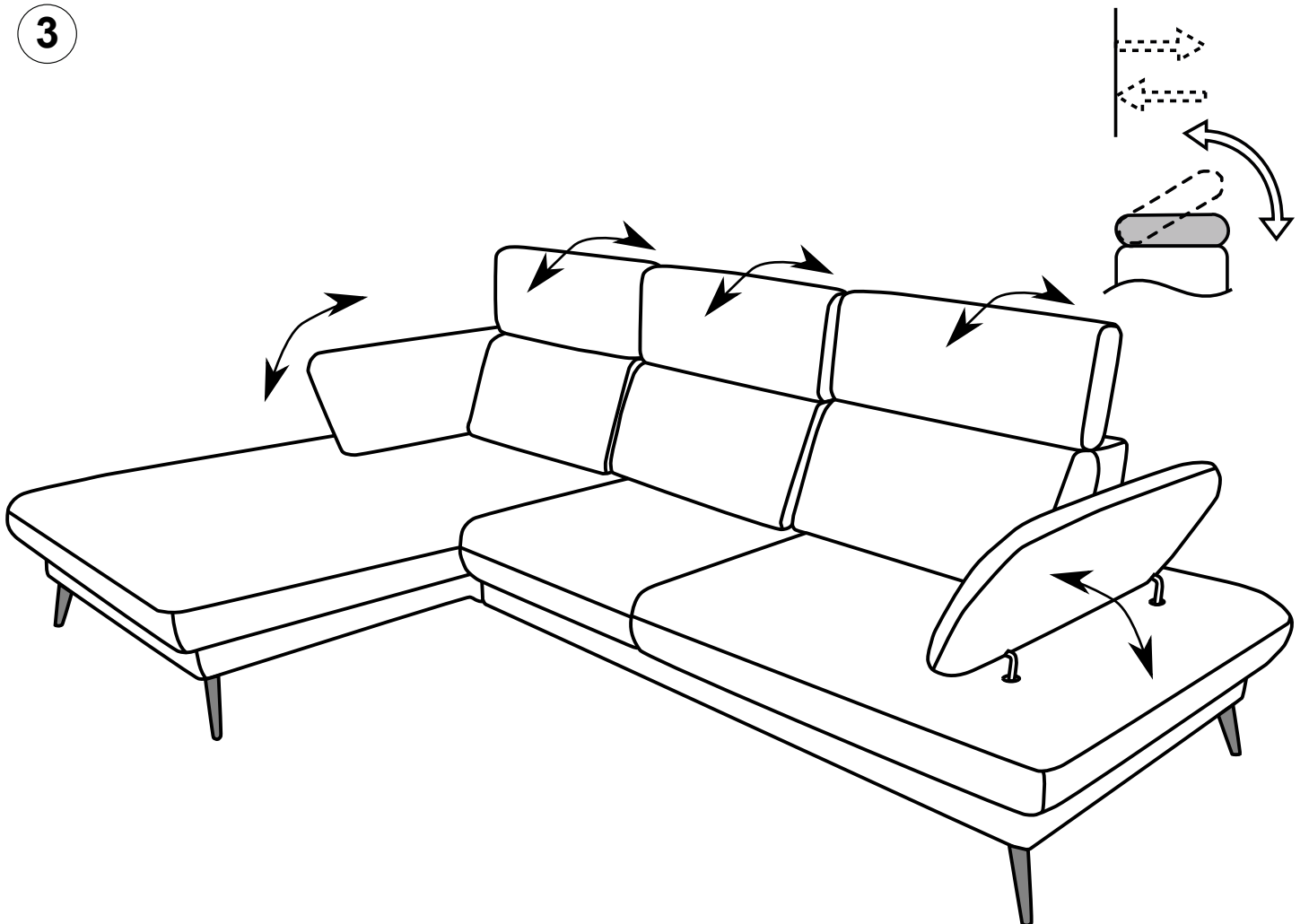

# SANTI/ SICILIA

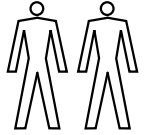
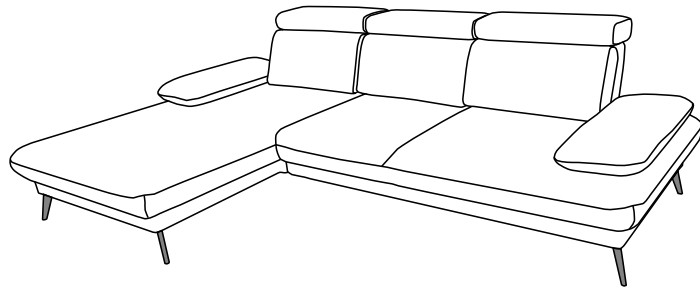

4

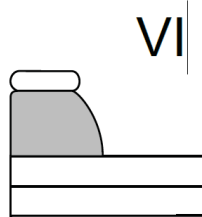
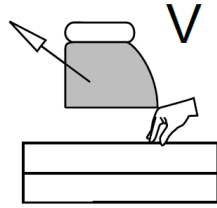
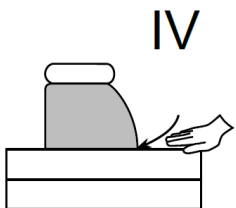
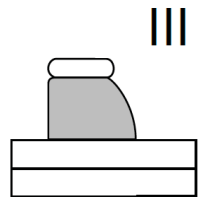
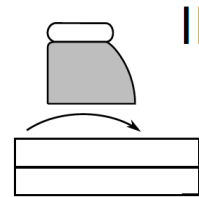
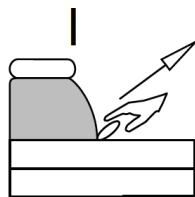
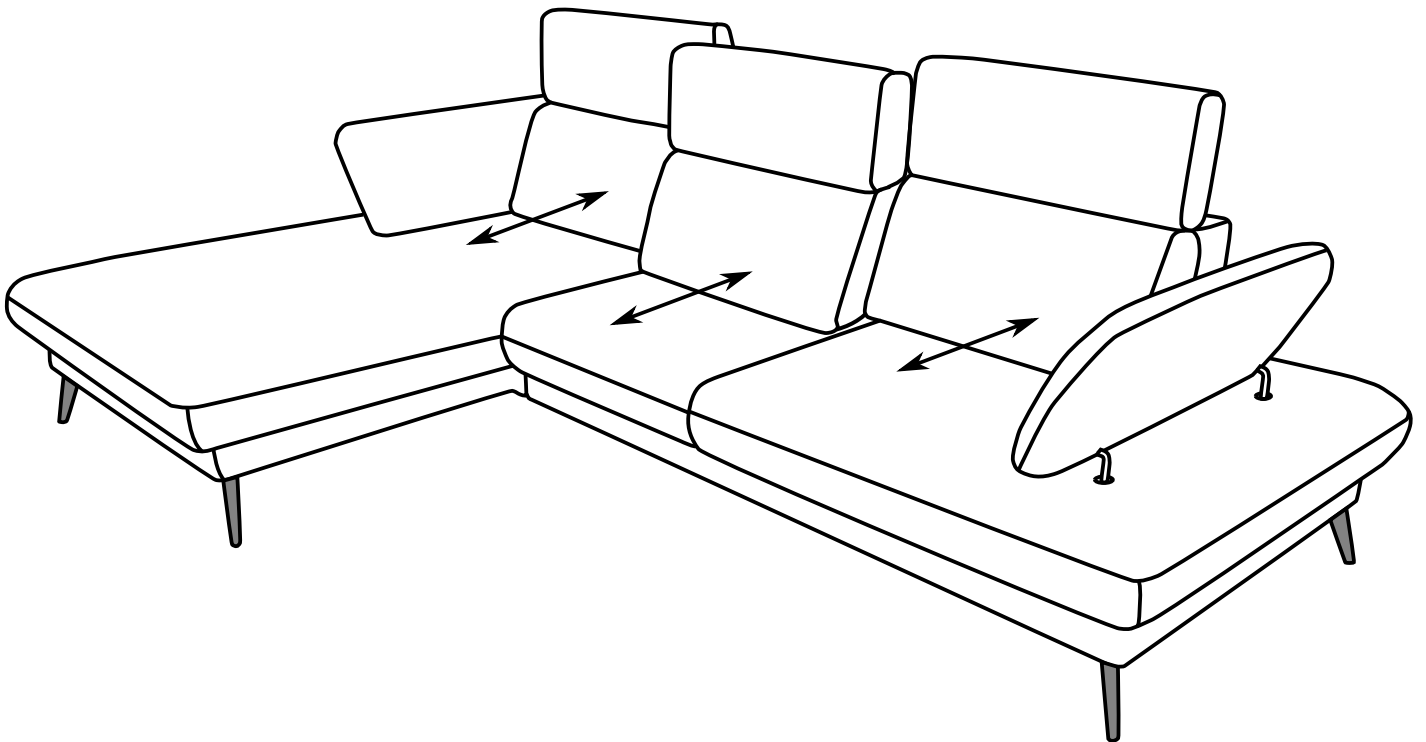

# SANTI/ SICILIA

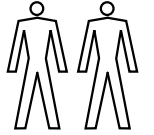
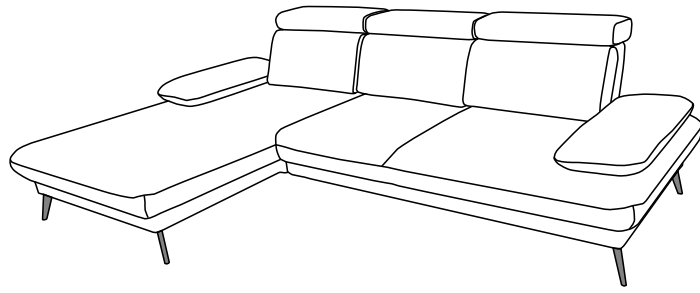

5

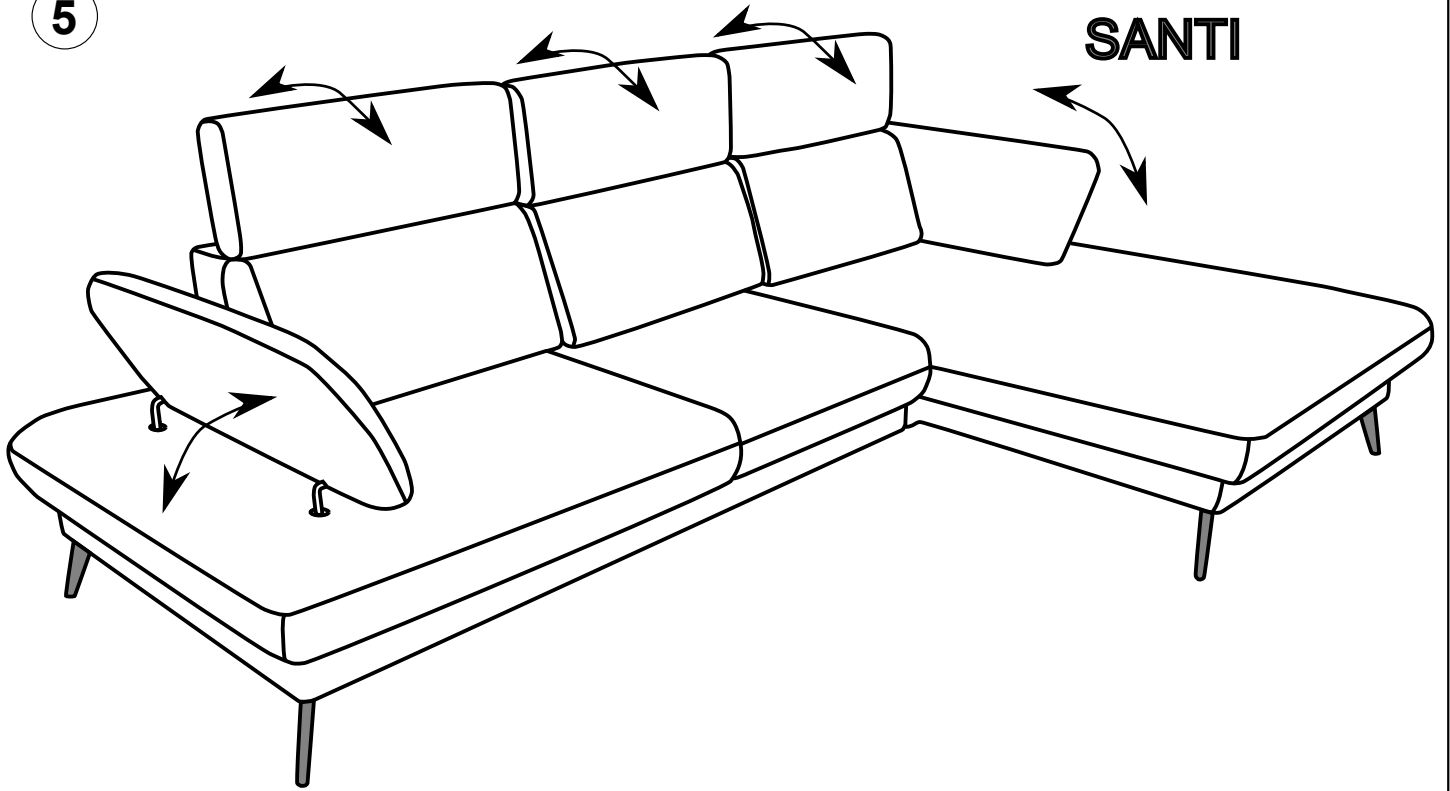

SICILIA

