

SANTI/ SICILIA

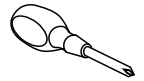

I

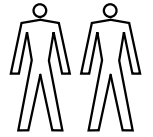
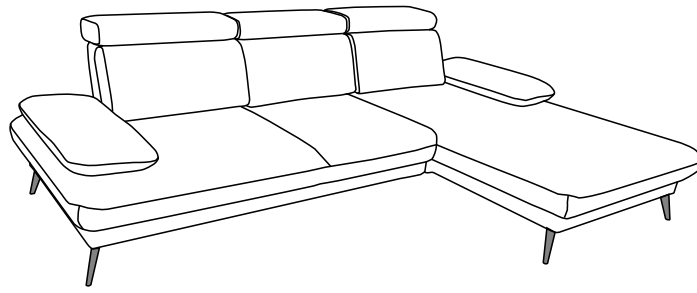
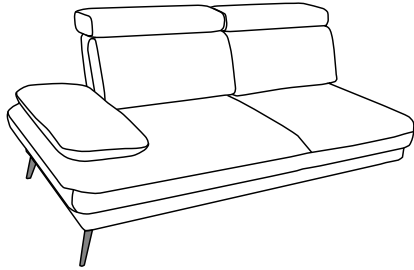

II

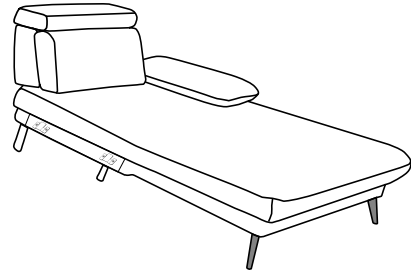

H=150mm

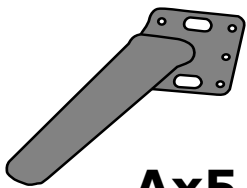

Ax5

H=150mm



Bx1

M6x25

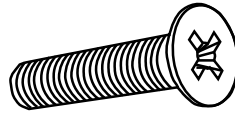

Cx10

Ø6mm



Dx10

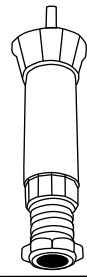

Ex1

1

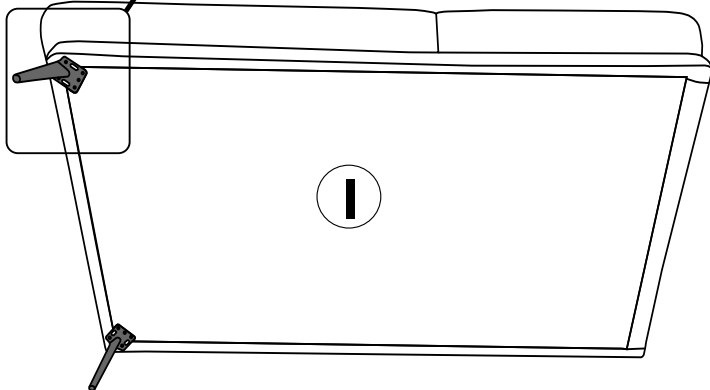
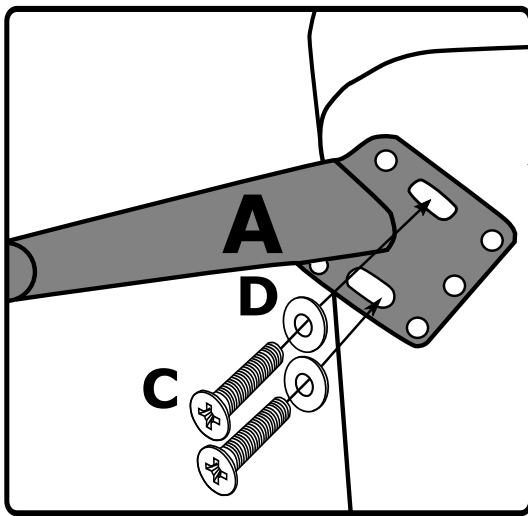

I

II

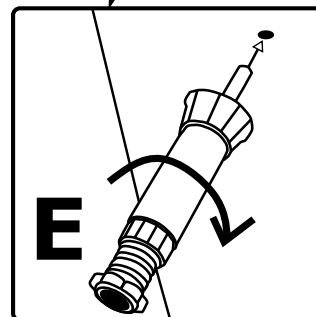

E

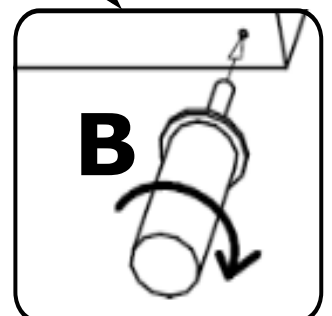

B

SANTI/ SICILIA

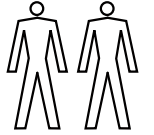
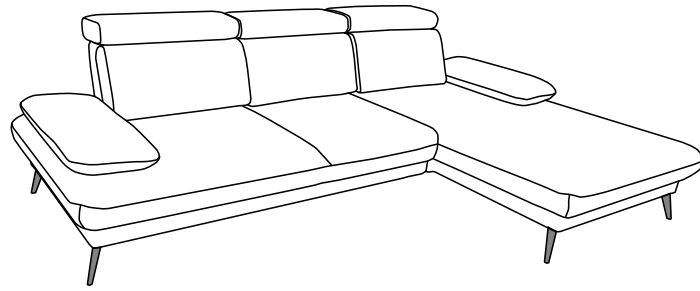

2

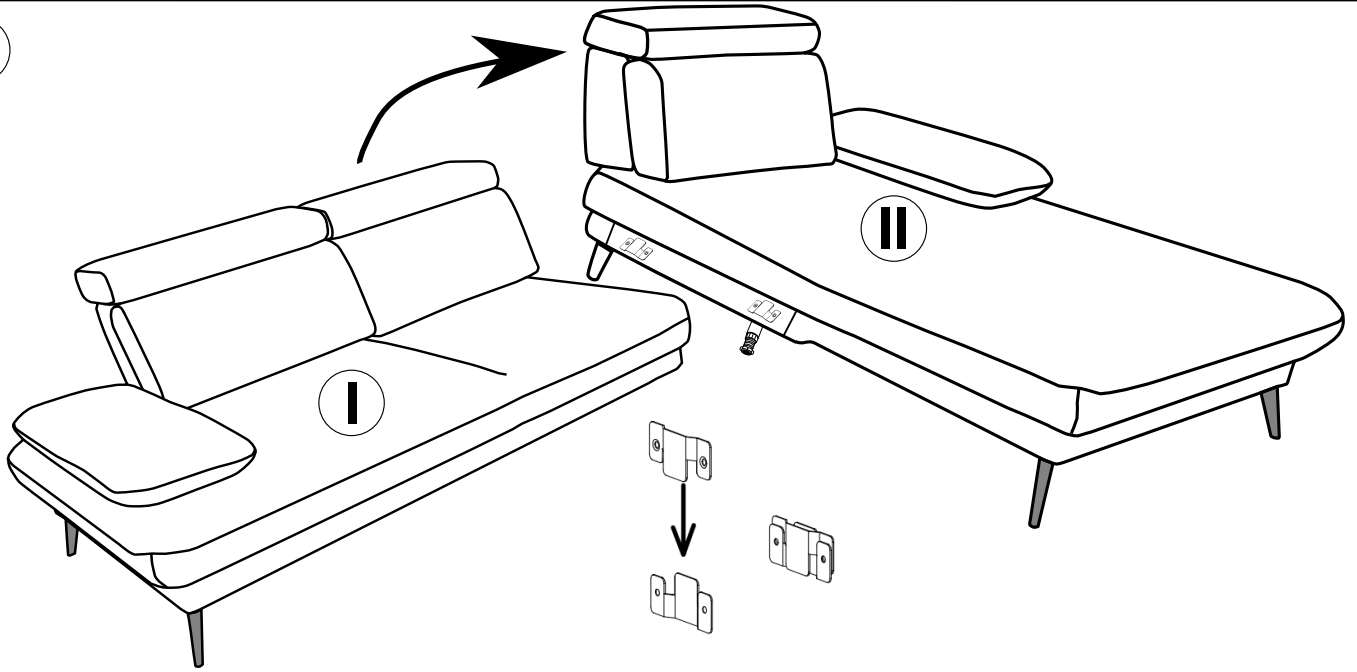

3

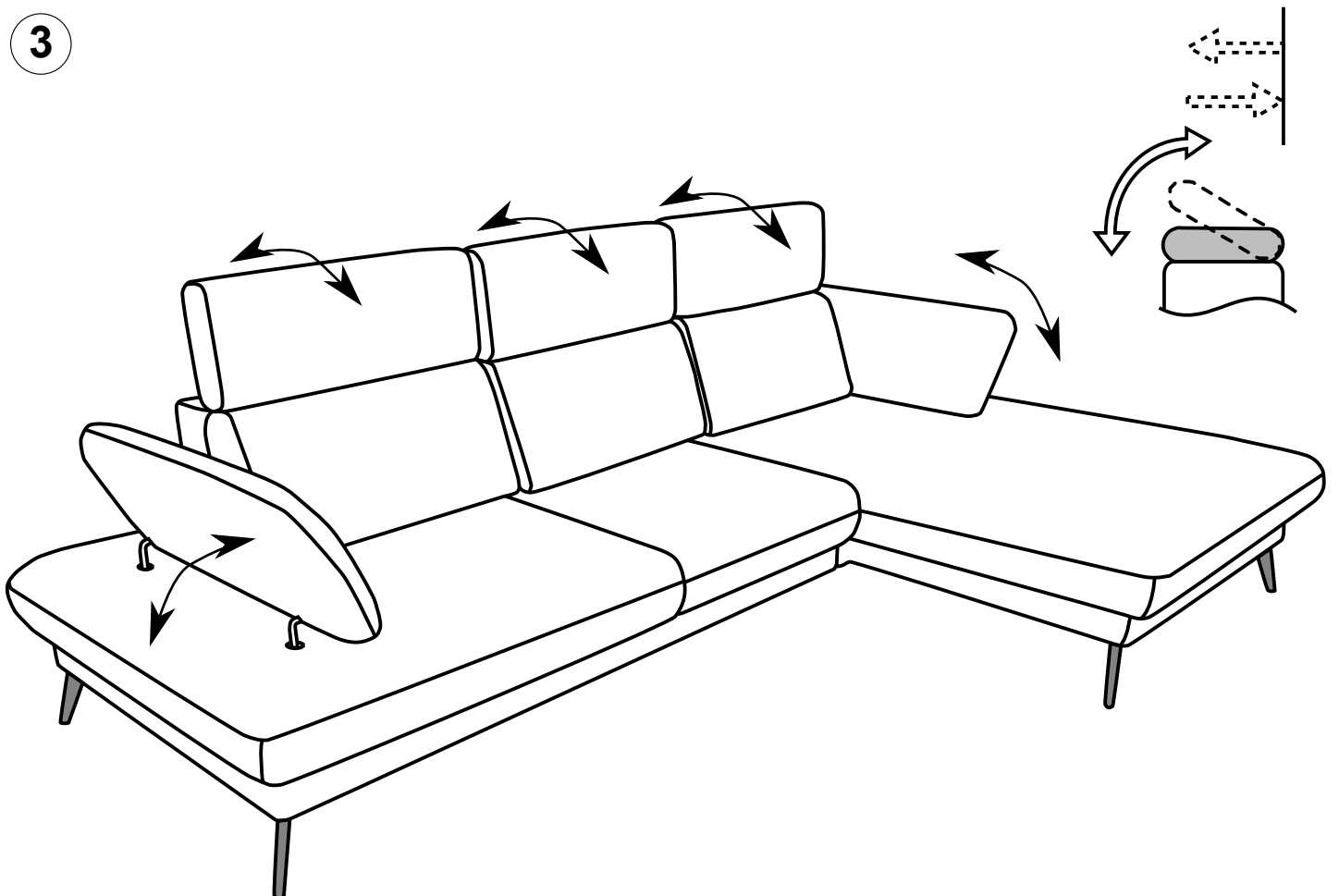

SANTI/ SICILIA

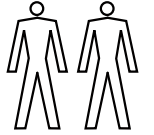
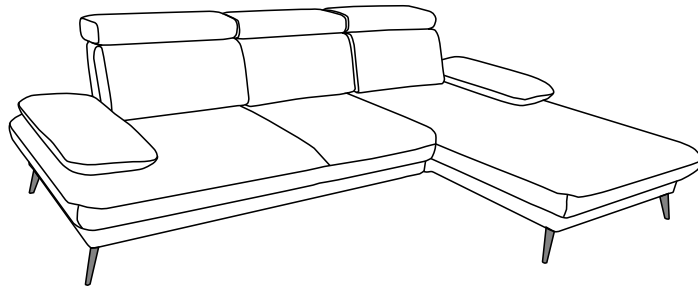

4

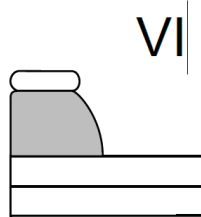
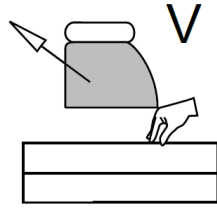
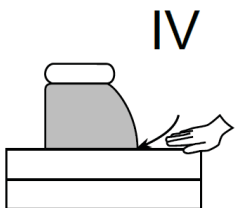
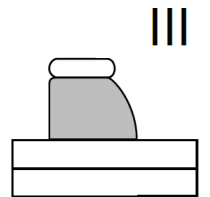
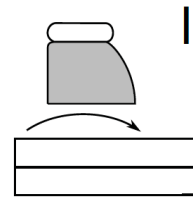
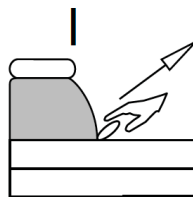
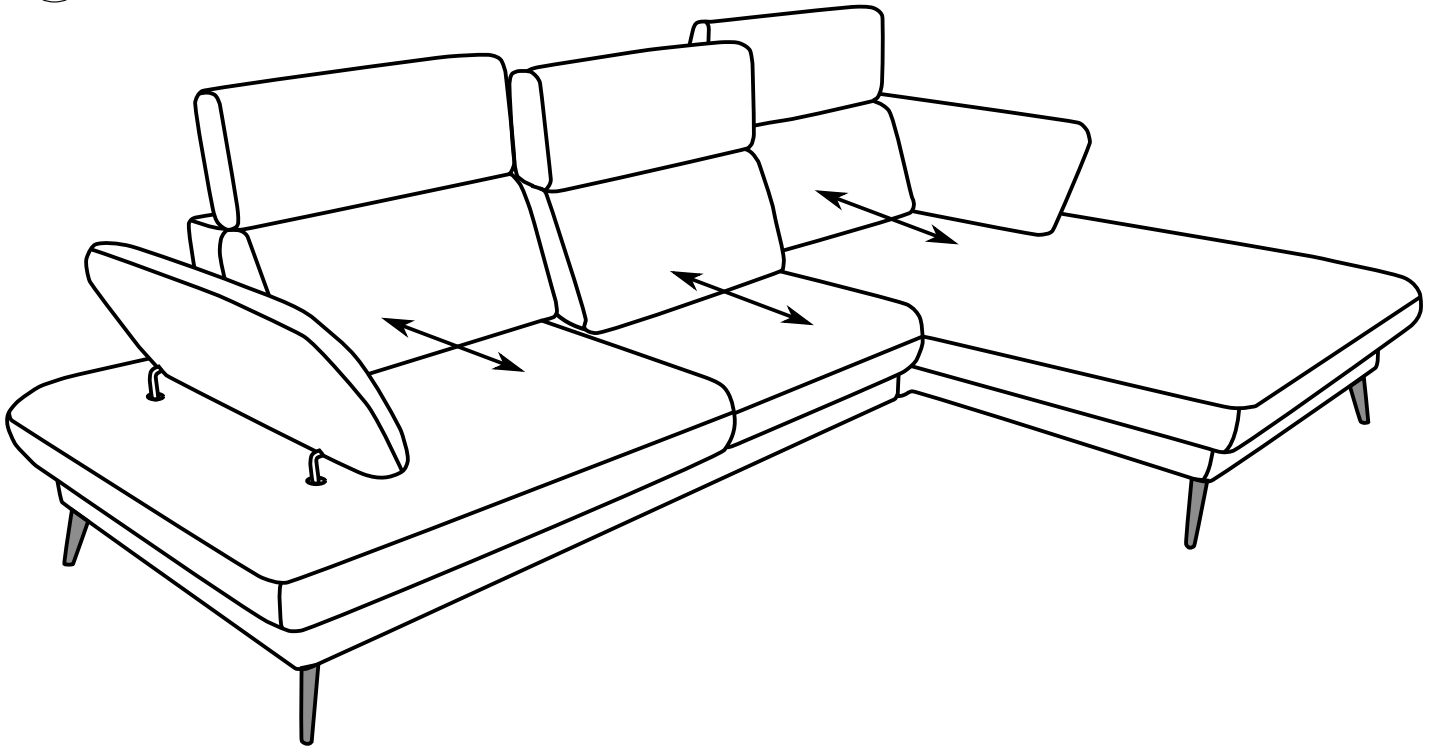

SANTI/ SICILIA

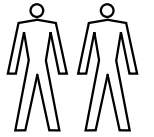
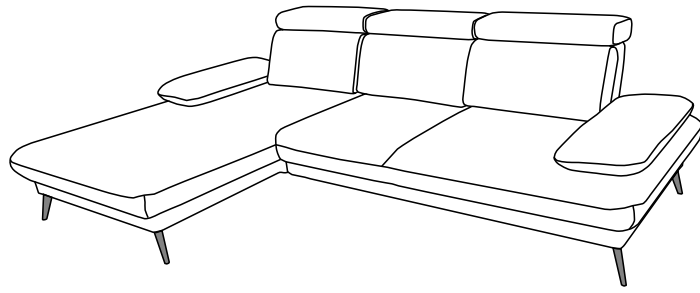

I

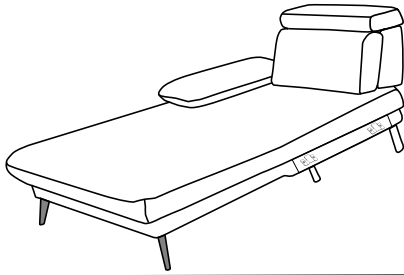

II

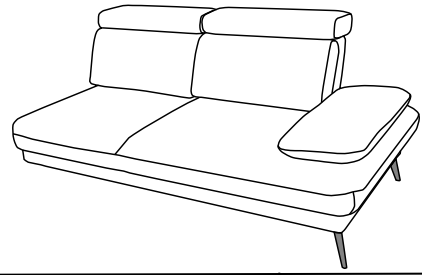

H=150mm

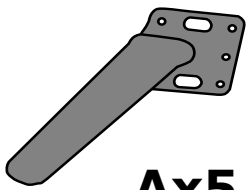

Ax5

H=150mm

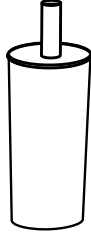

Bx1

M6x25

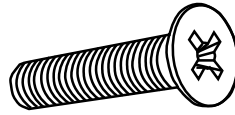

Cx10

Ø6mm



Dx10

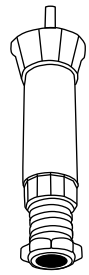

Ex1

1

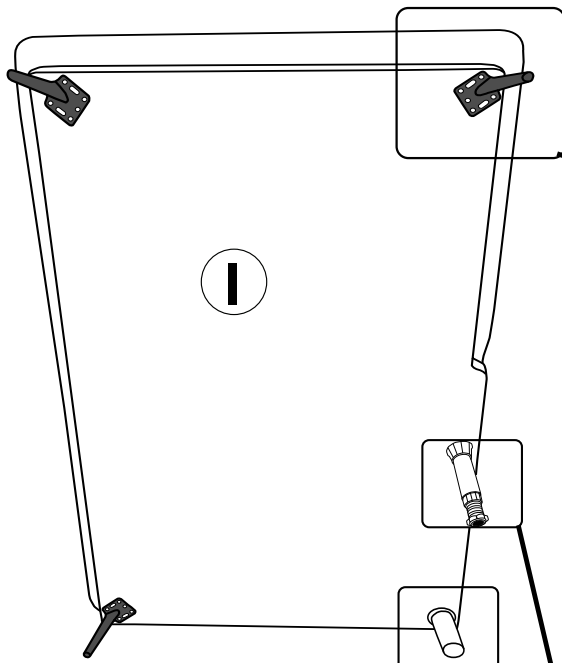

I

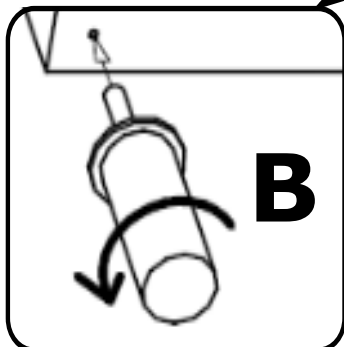
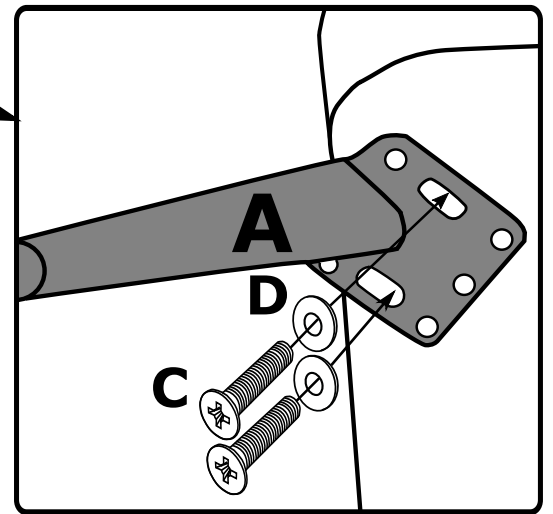

B

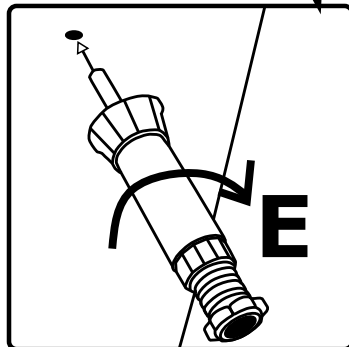

E

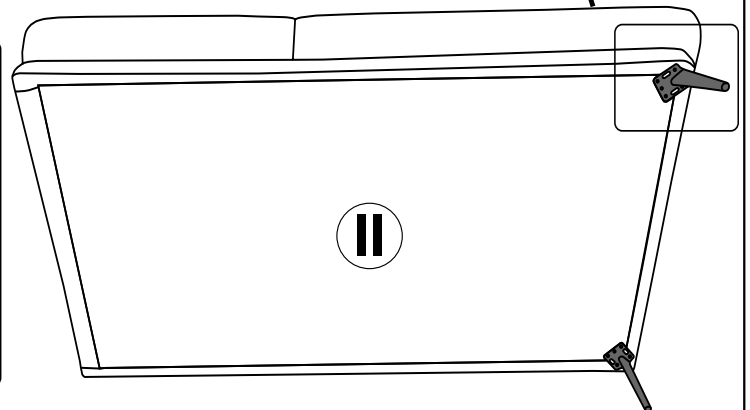

II

SANTI/ SICILIA

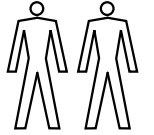
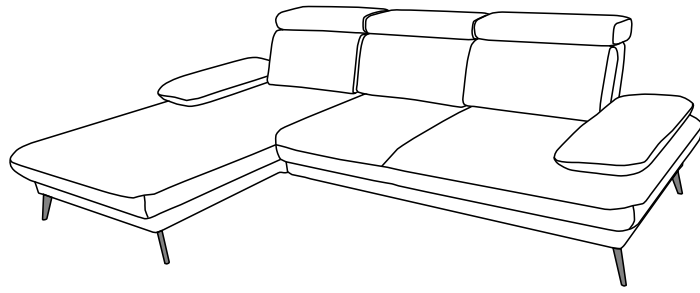

2

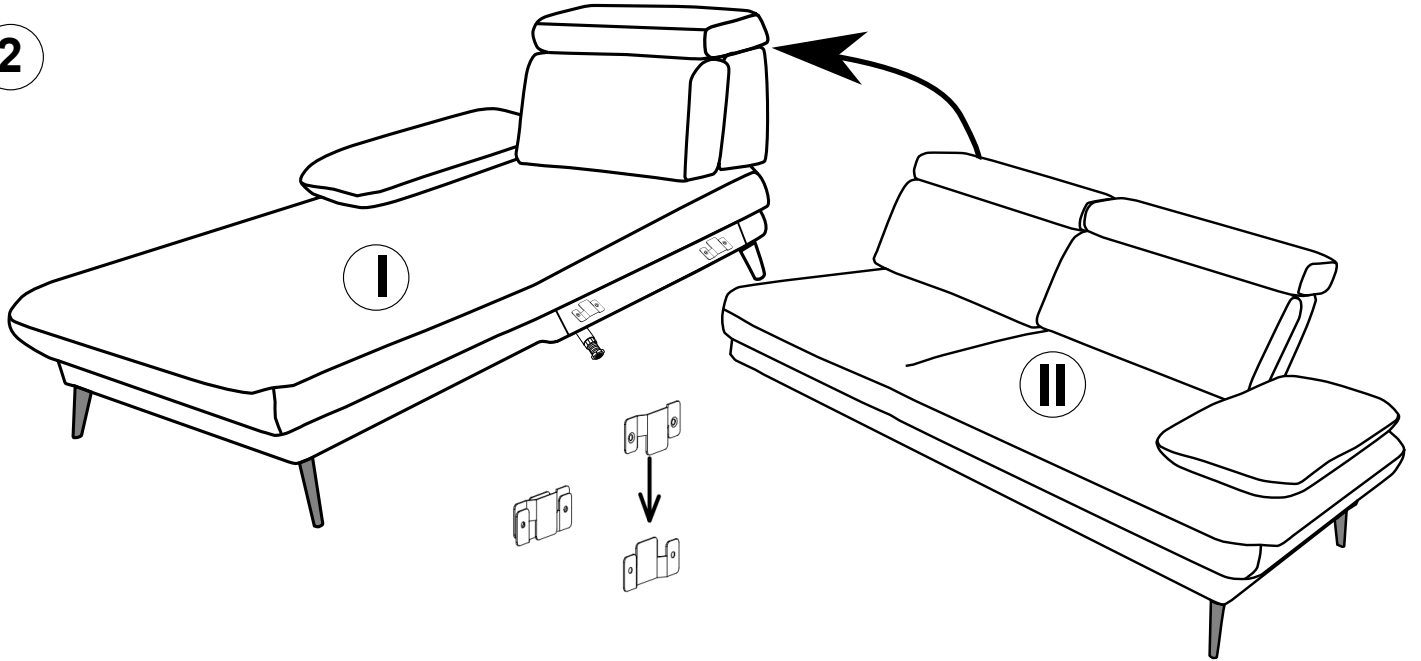

3

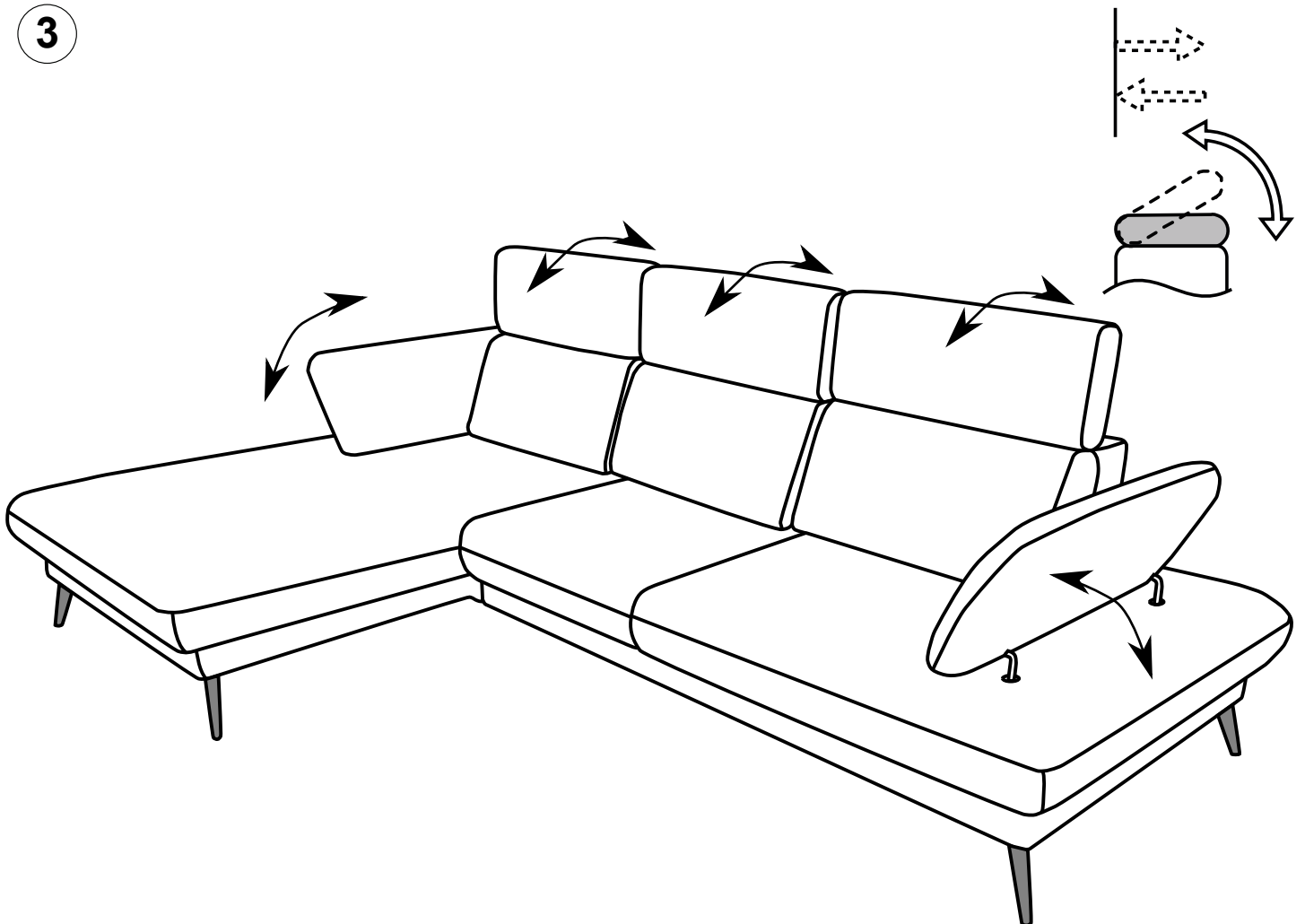

SANTI/ SICILIA

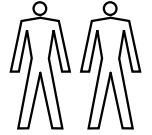
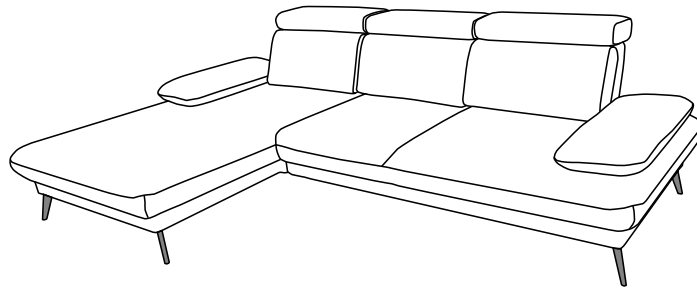

4

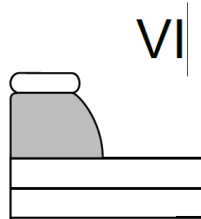
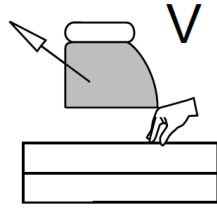
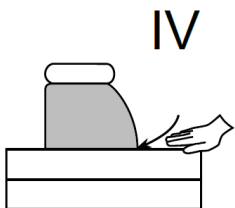
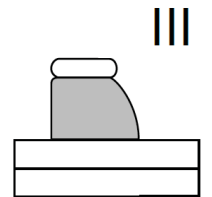
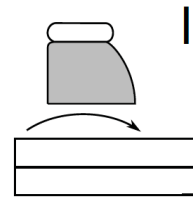
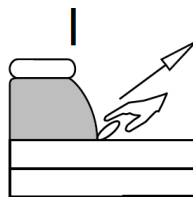
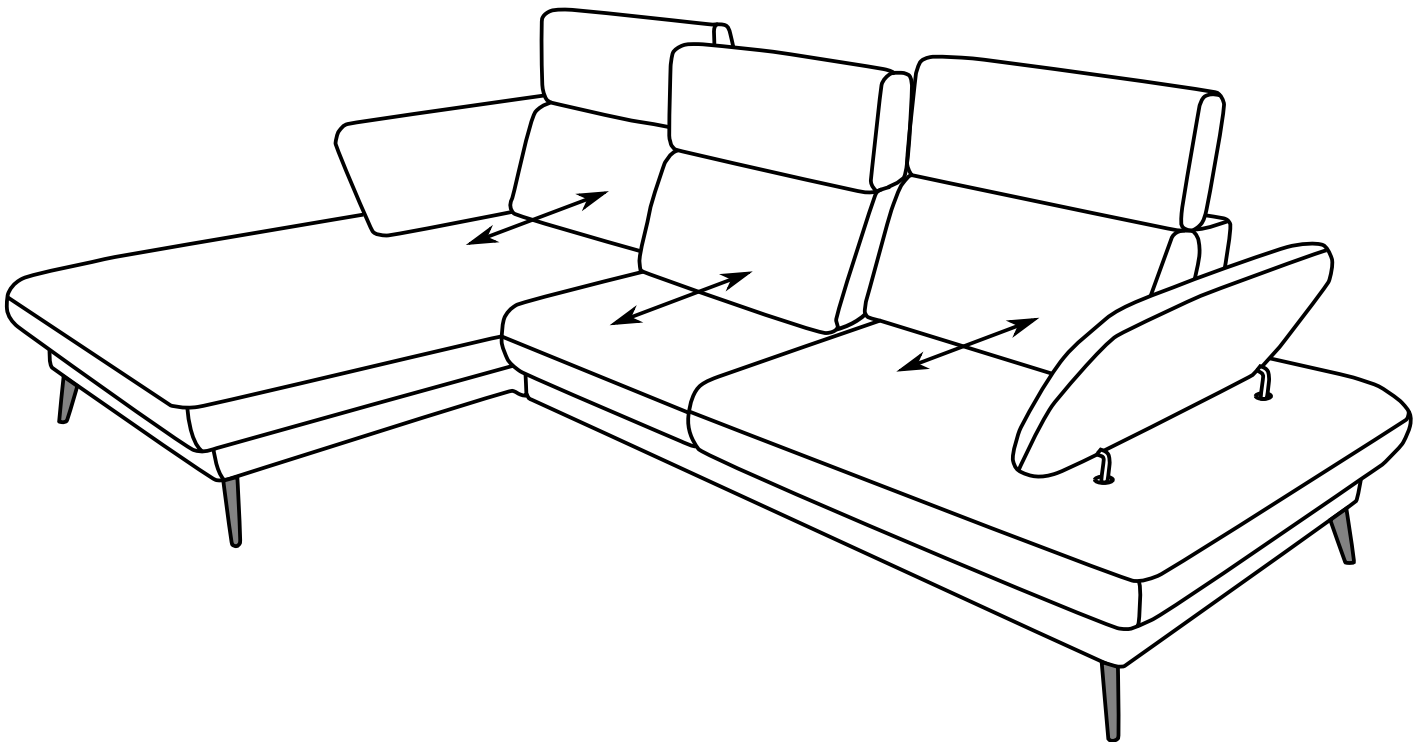

SANTI/ SICILIA

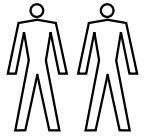
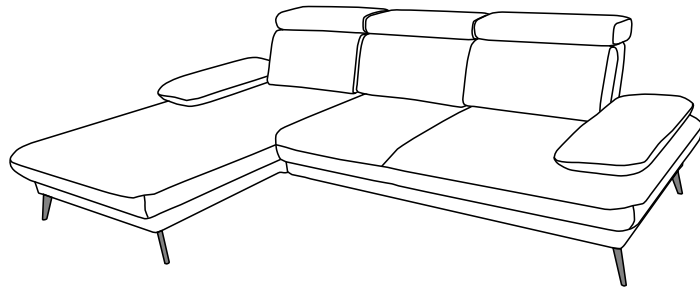

5

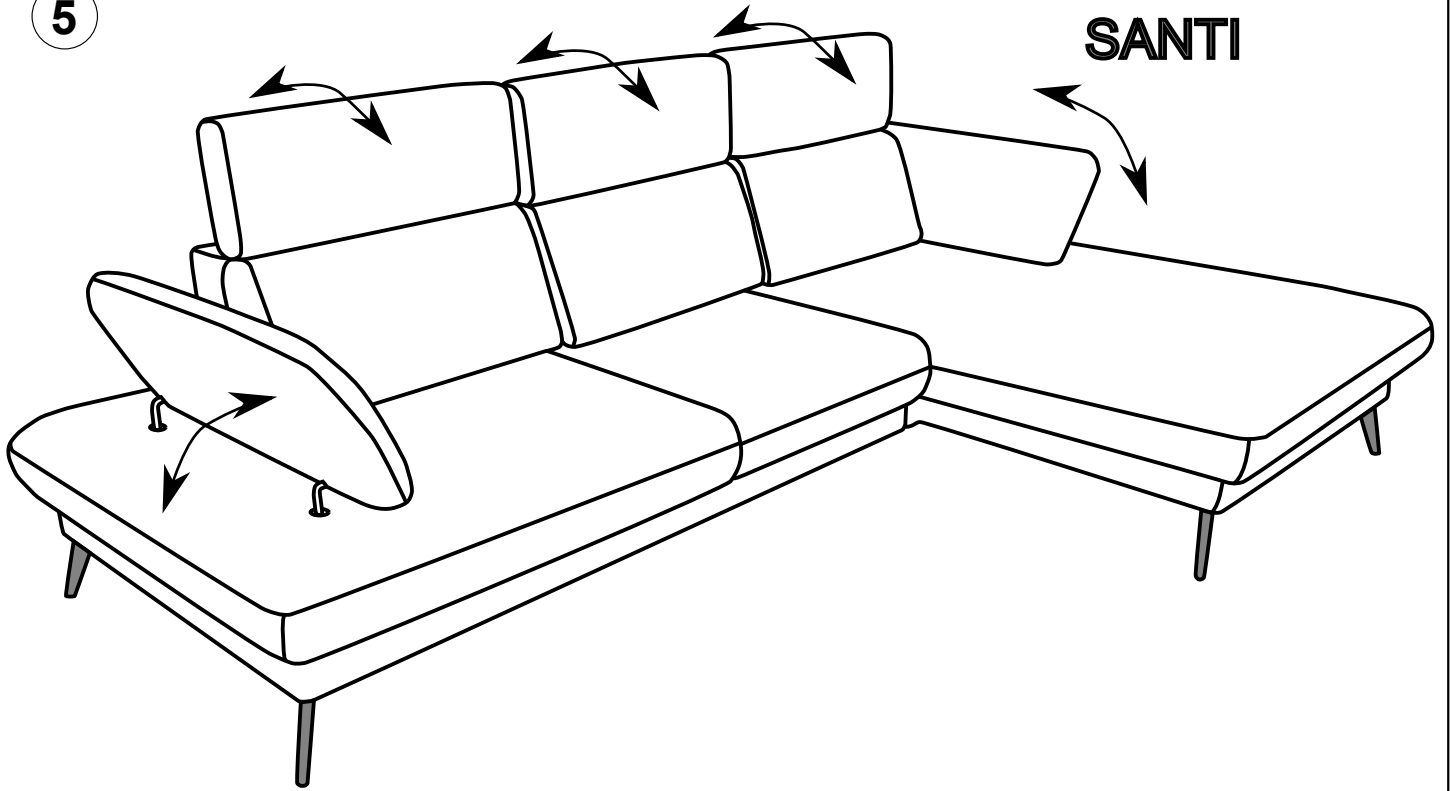

SANTI

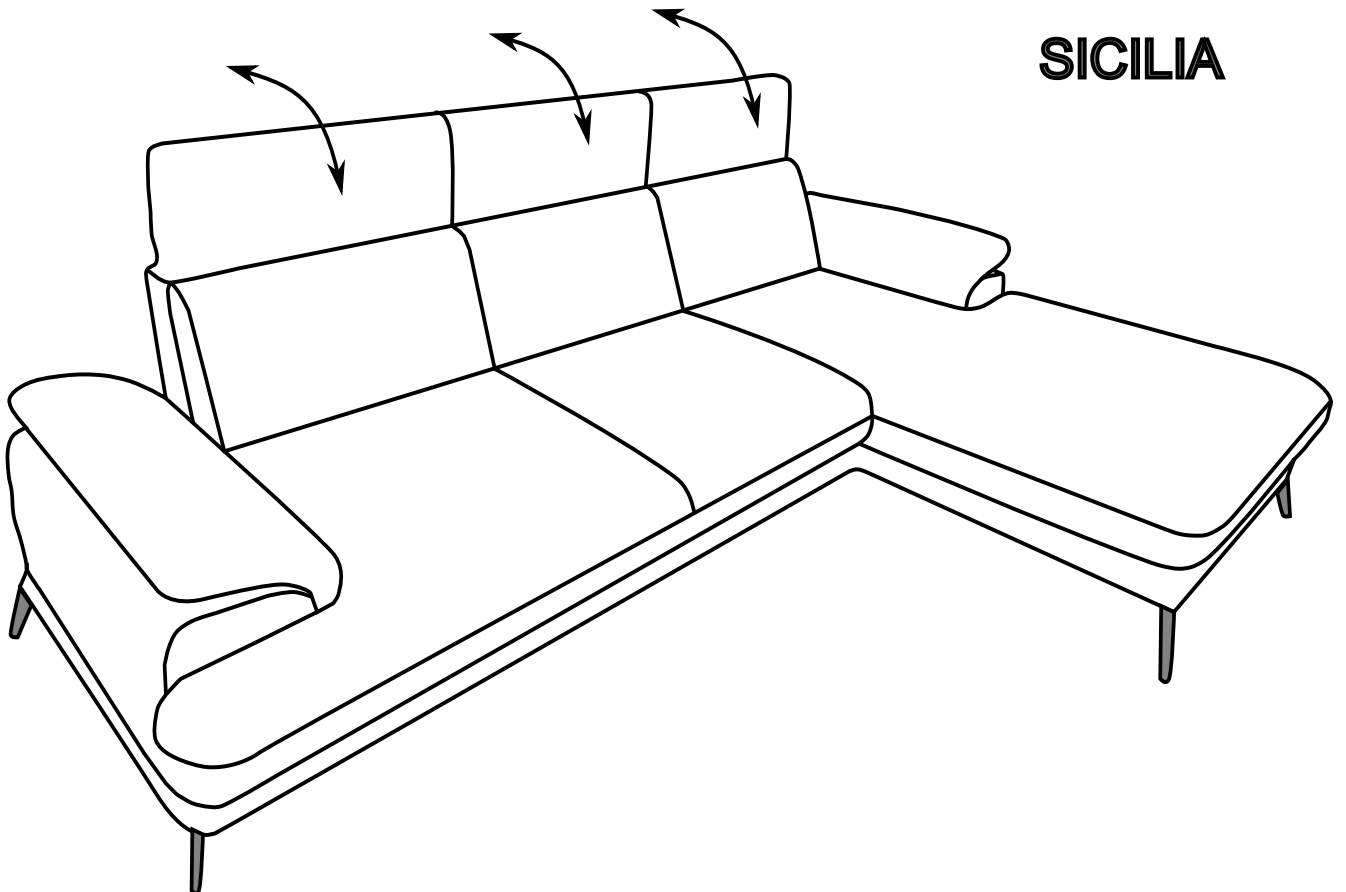

SICILIA