

Modellname: **Opti**  
 Nazwa modelu:

Modellreihe: **9X -- OP 31**  
 Numer modelu:

Type:  
 Typ:

Blatt Nr **1** von: **4**  
 Strona **1** z:

**Pflegehinweis!**

Bitte nur mit einem Staubtuch oder einem feuchten Lappen reinigen.

**KEINE** scheuernde Putzmittel verwenden!

**Wskazówka dotycząca pielęgnacji!**

Proszę czyścić tylko suchą lub lekko wilgotną szmatką do kurzu. Nie używać żadnych środków szorstkich!

**MONTAGEANLEITUNG**  
**INSTRUKCJA MONTAŻOWA**

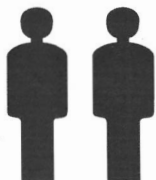

**2 Personen**  
**2 Osoby**

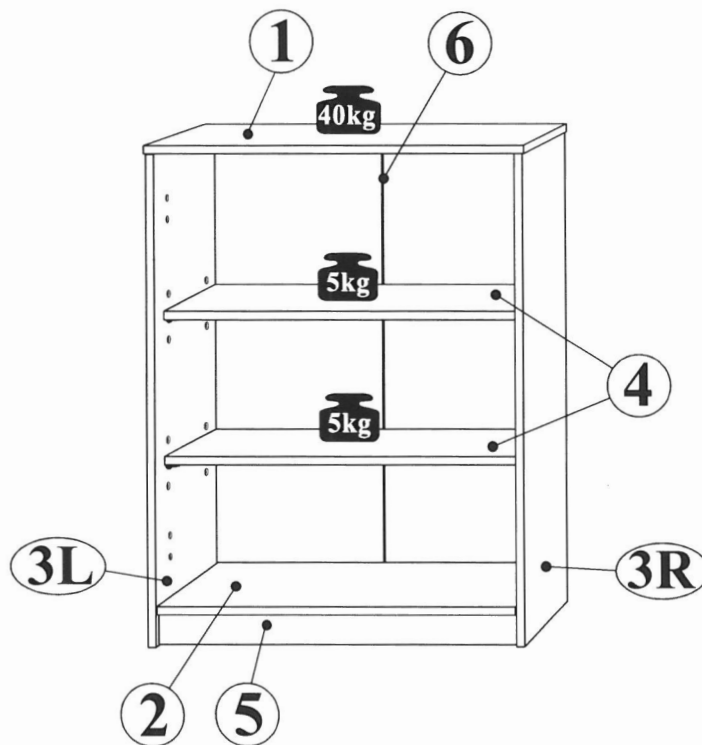
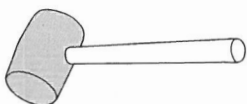
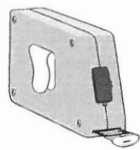

Max. zulässige Belastungen  
 von Einlegeböden in kg:

Maksymalne obciążenie półek w kg:

Stärke/Gr. Länge/Dł. mm	Spanplatte/Płyta		
	15	18	22
0<400			
401<600	40	40	40
601<800	24		
801<1000	15	30	

NR 1

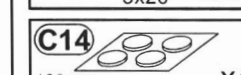
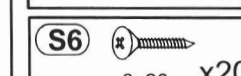
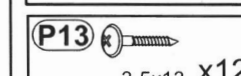
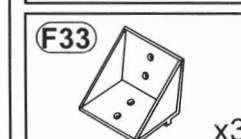
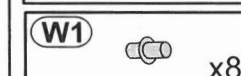
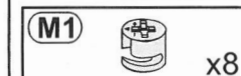
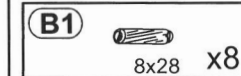

NR 2

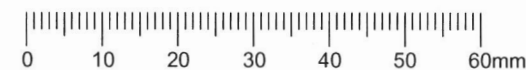
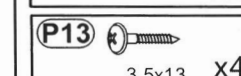
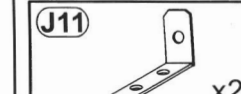

Modellname: **Opti**  
Nazwa modelu:

Modellreihe: **9X -- OP 31**  
Numer modelu:

Type:  
Typ:

Blatt Nr 2 von: 4  
Strona z:

**1**

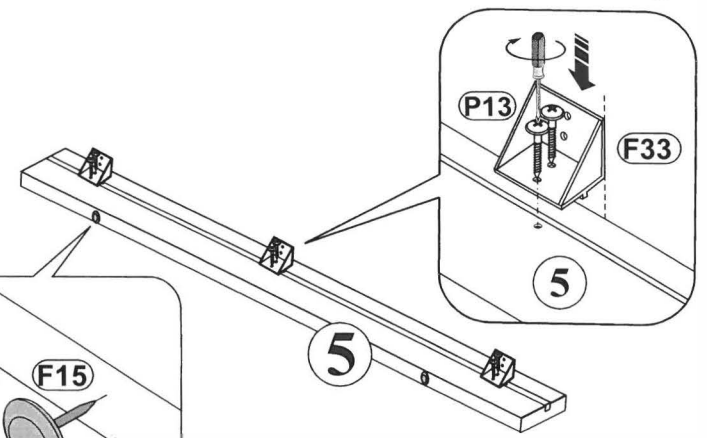
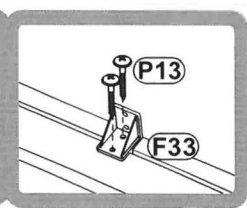
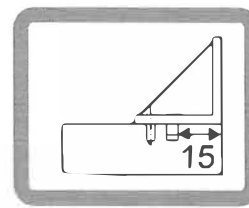
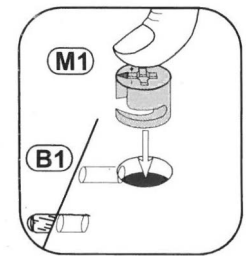
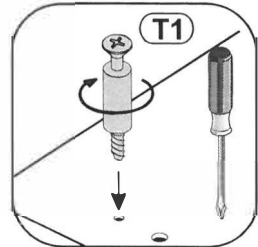
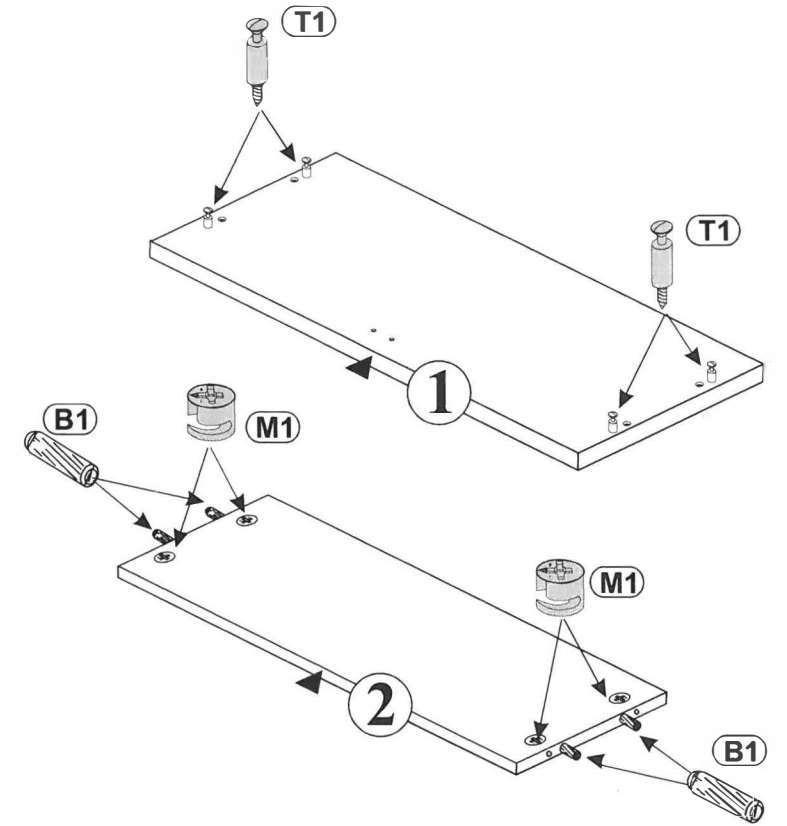
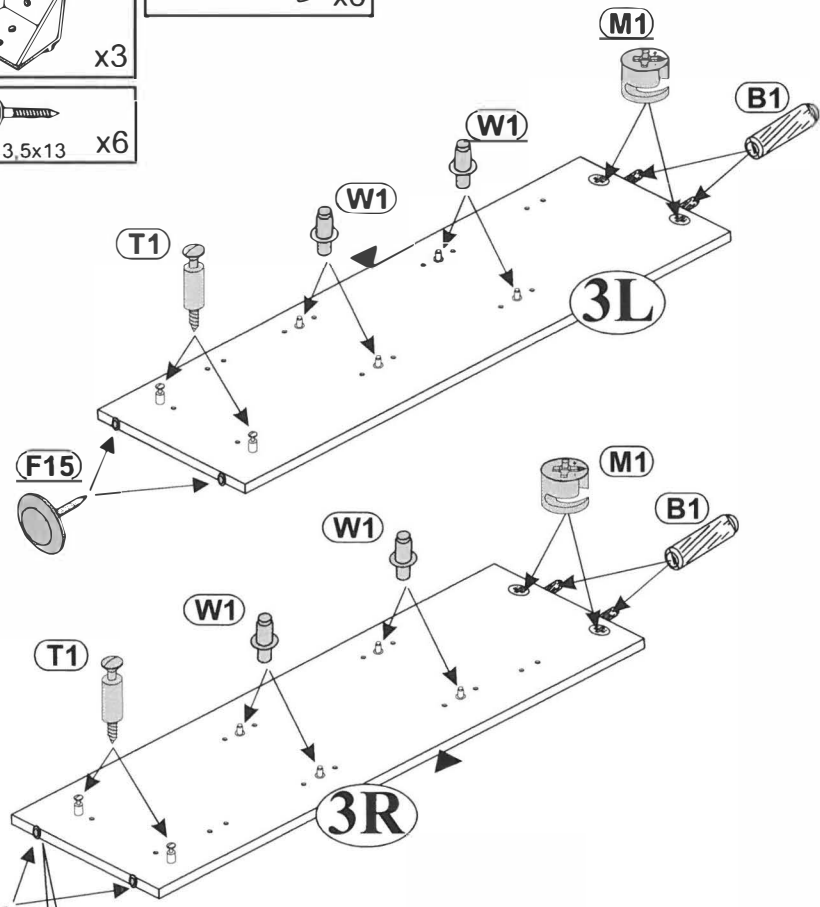
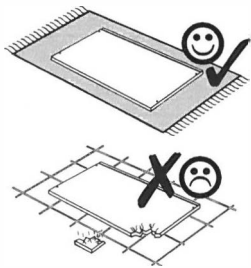
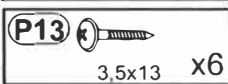
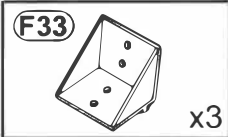
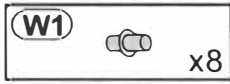
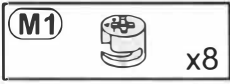
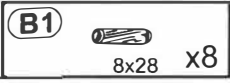

2

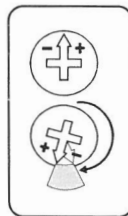
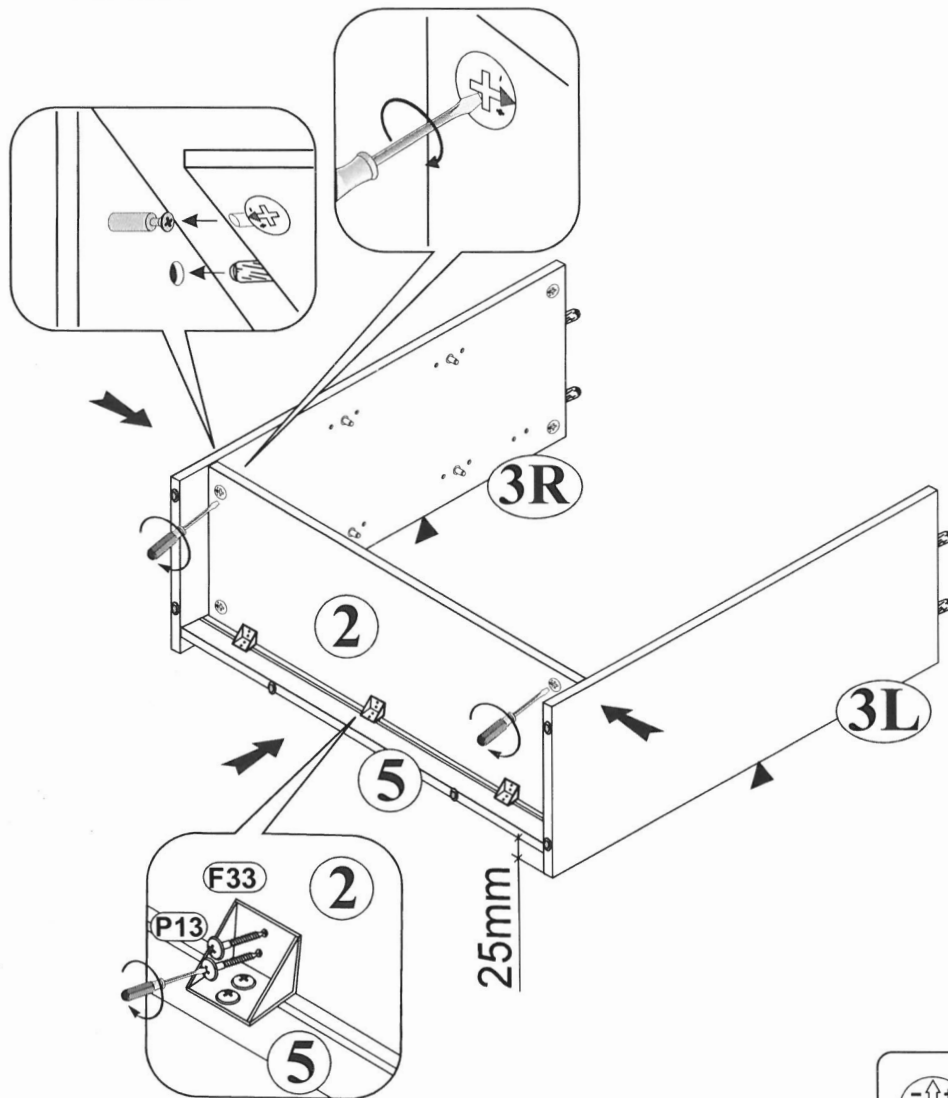
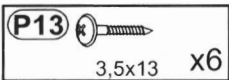

3

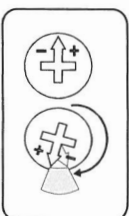
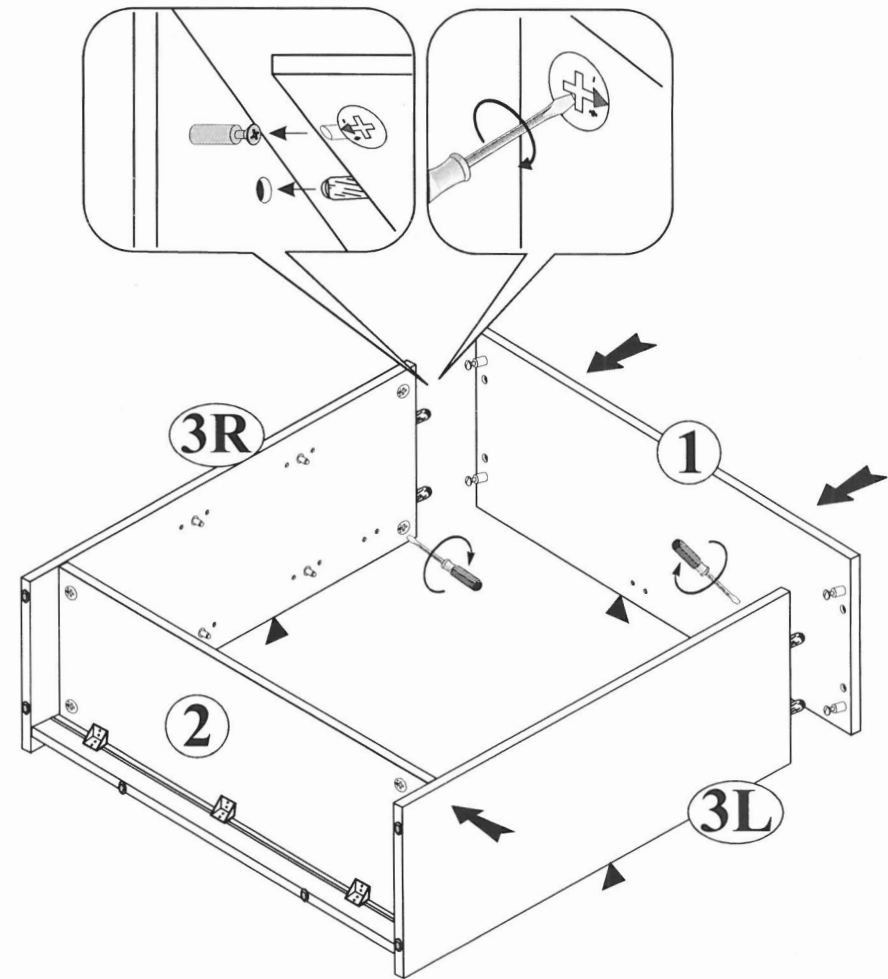

Modellname: **Opti**  
Nazwa modelu:

Modellreihe: **9X -- OP 31**  
Numer modelu:

Type:  
Typ:

Blatt Nr 4 von: 4  
Strona z:

4

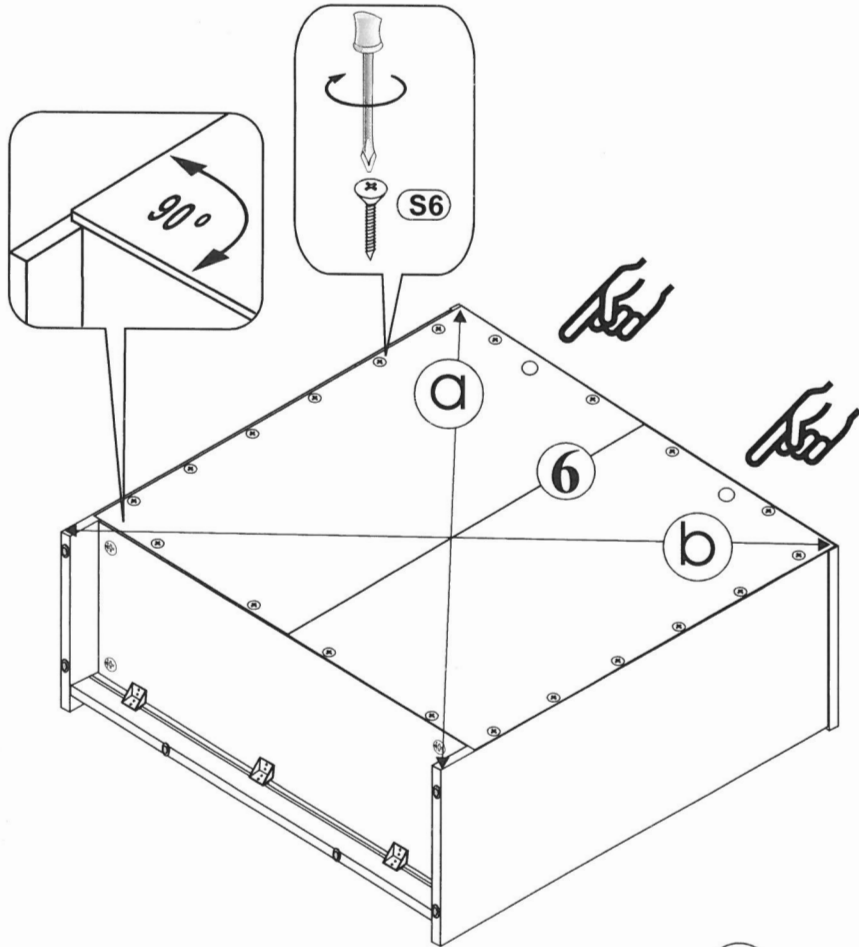
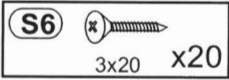

a=b

5

