

# TIRION T

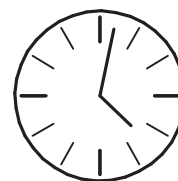

60 min

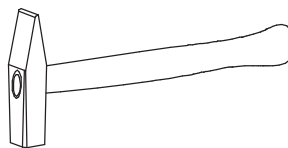
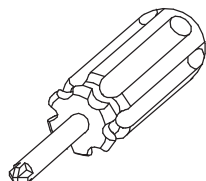
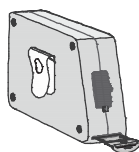
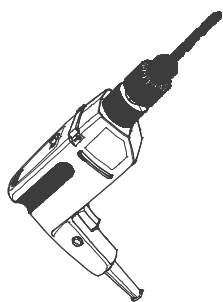
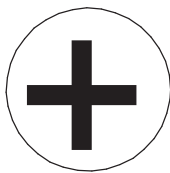
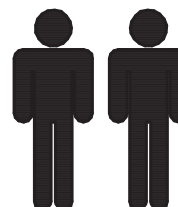

420 mm

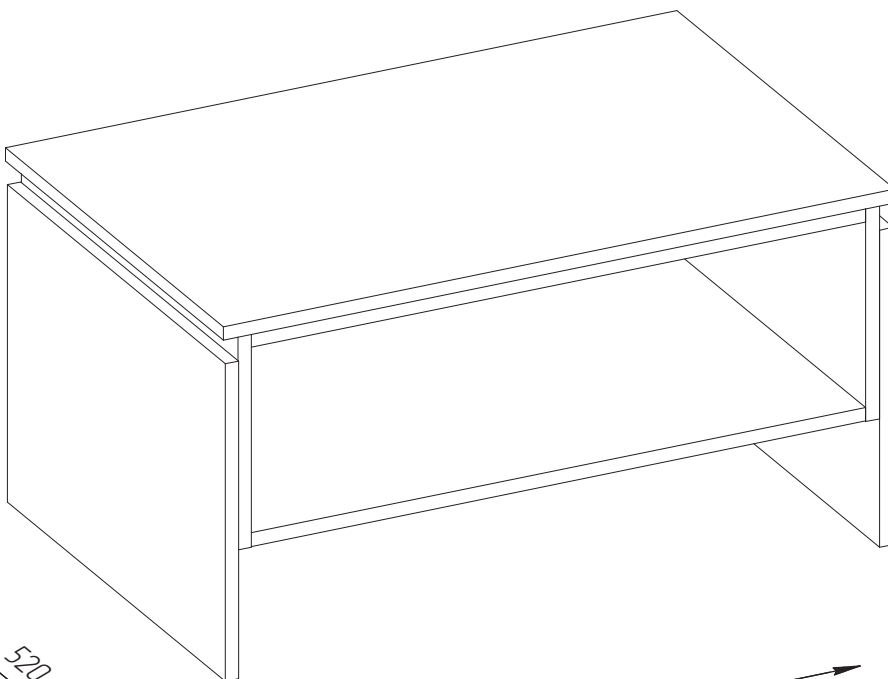

520 mm

800 mm

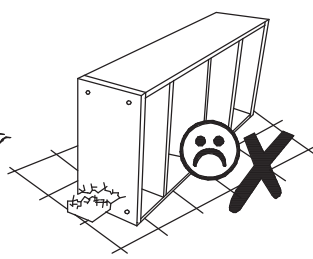
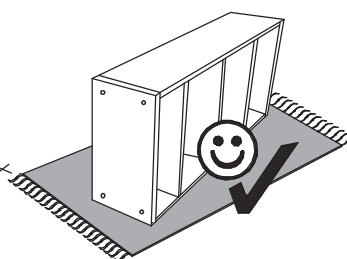
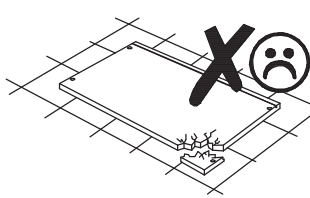
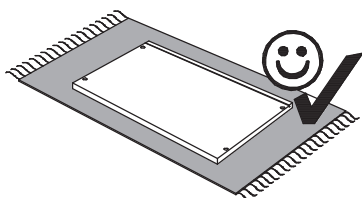

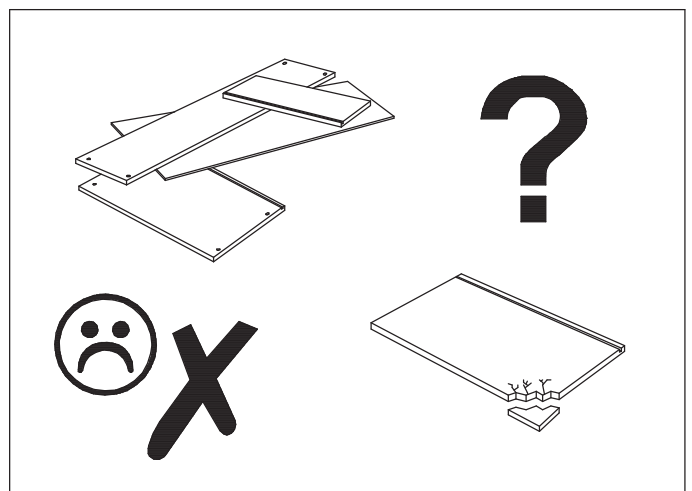
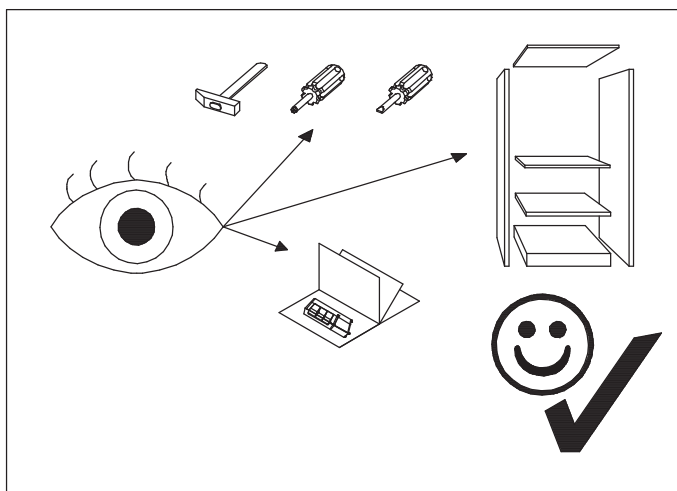
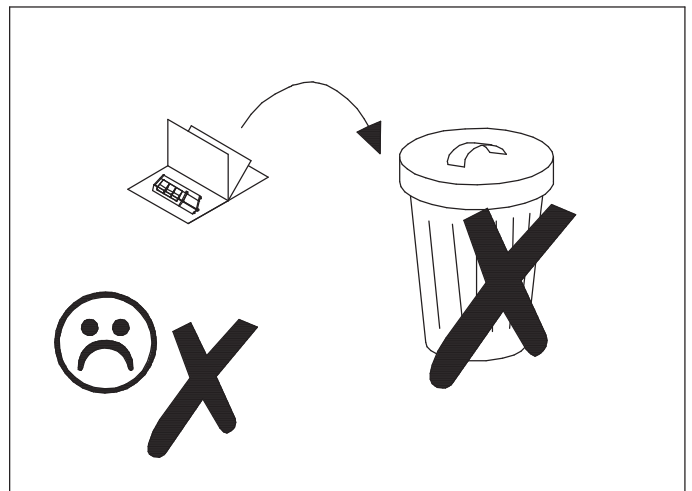
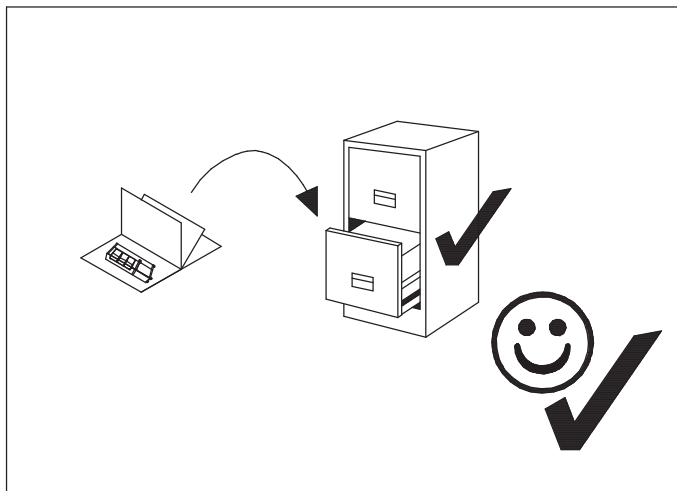
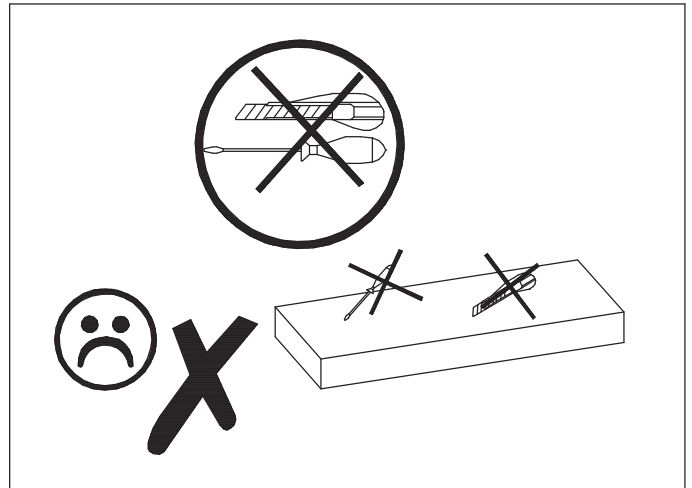
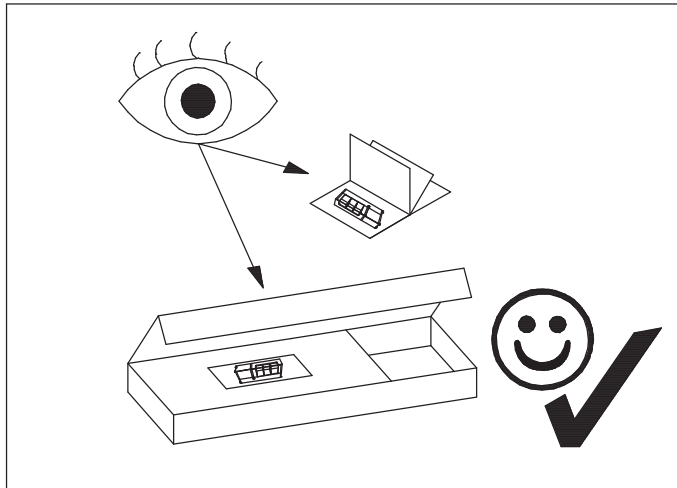

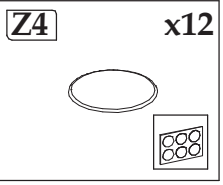
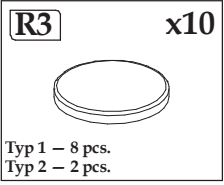
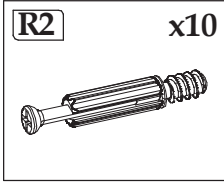
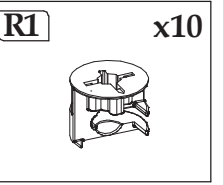
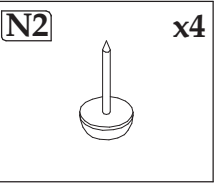
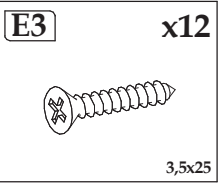
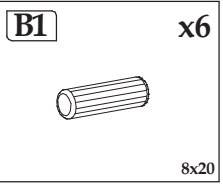
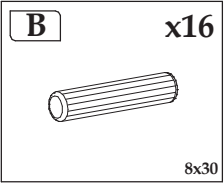
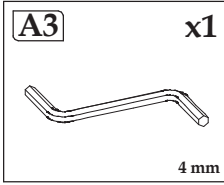

Element symbol	Measurements				Code	Pack
1	800	520	16	1	1001	1/ 1
2	520	371	16	2	1002/ 1007	1/ 1
3	764	70	16	1	1008	1/ 1
4	732	516	16	1	1006	1/ 1
5	249	518	16	2	1003/ 1004	1/ 1
6	732	516	16	1	1005	1/ 1

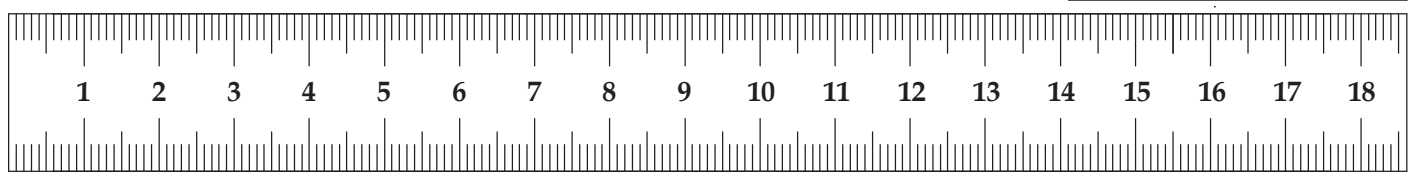
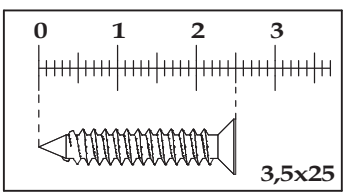
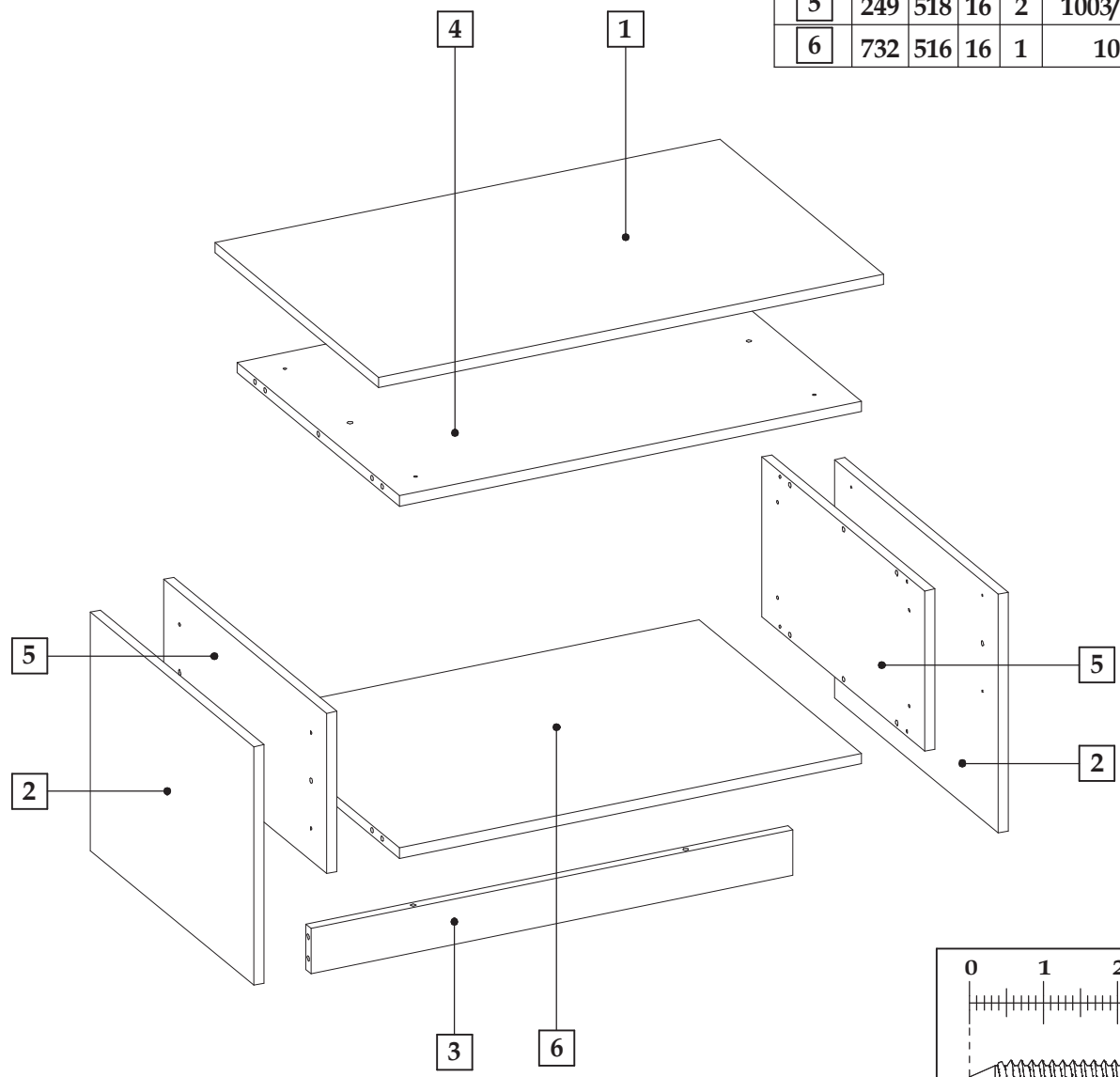

▶ 1

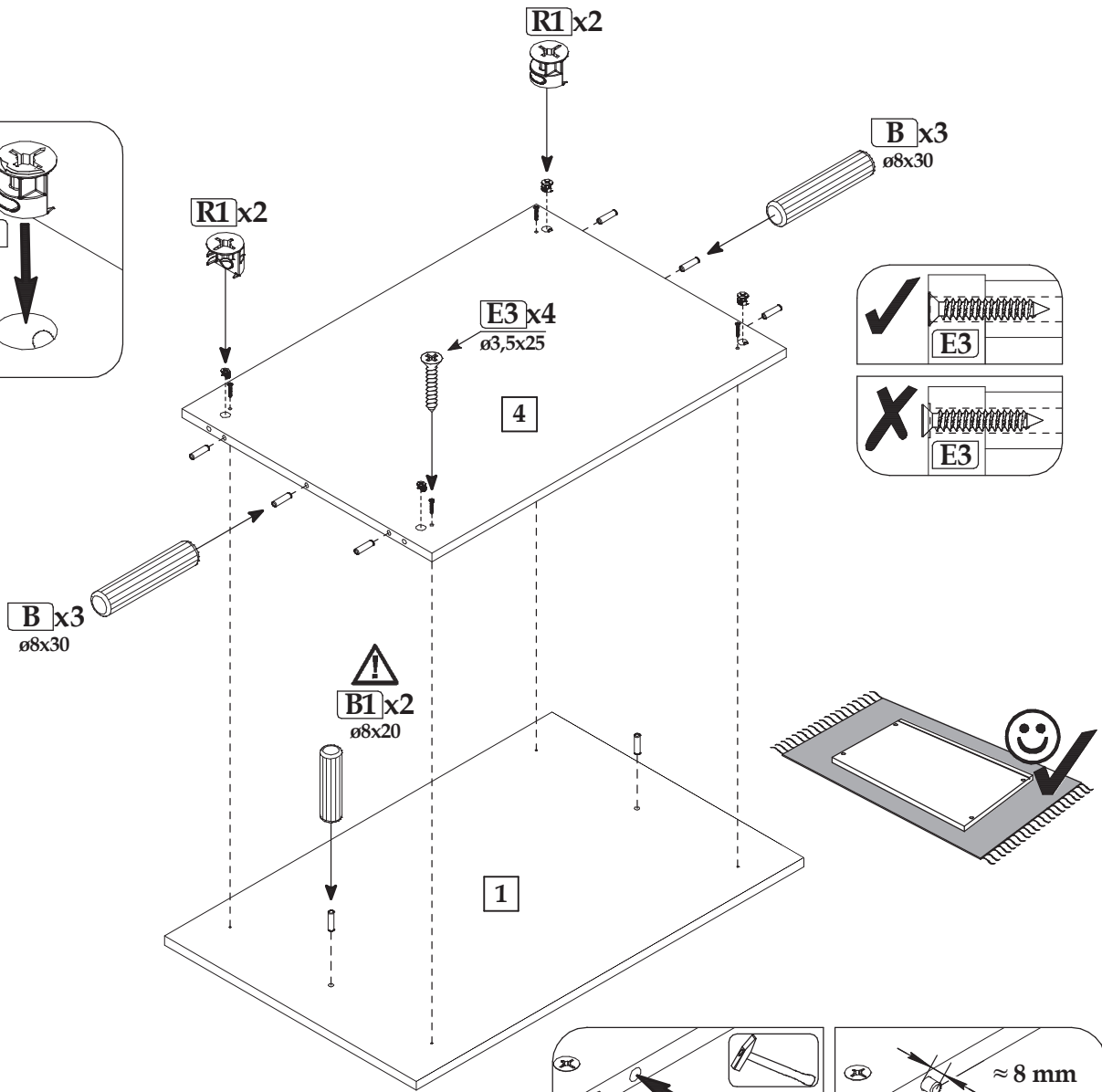
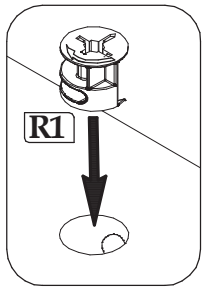

▶ 2

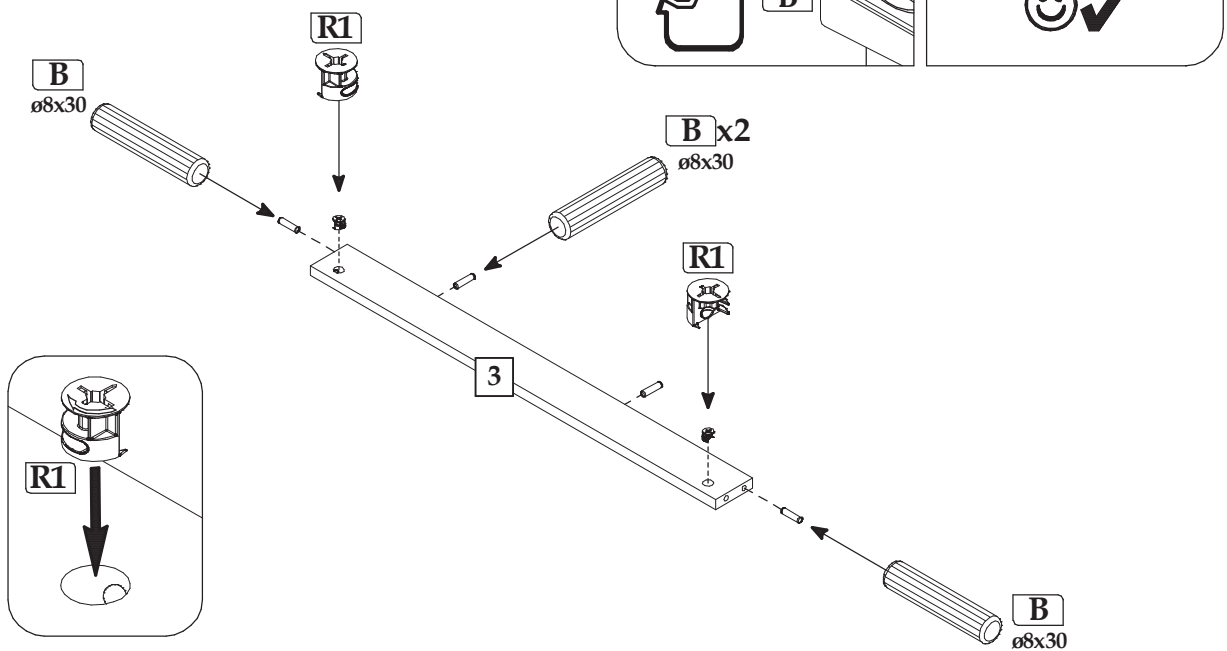

▶ 3

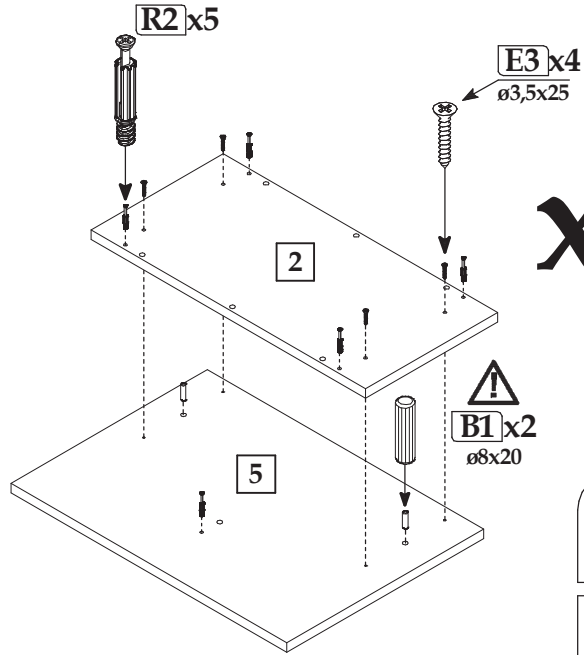
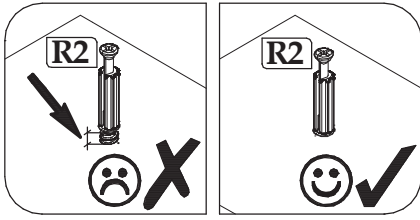

x2

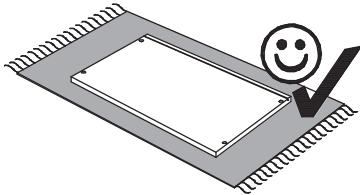
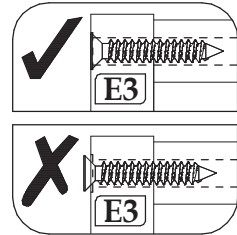

▶ 4

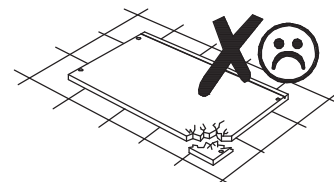
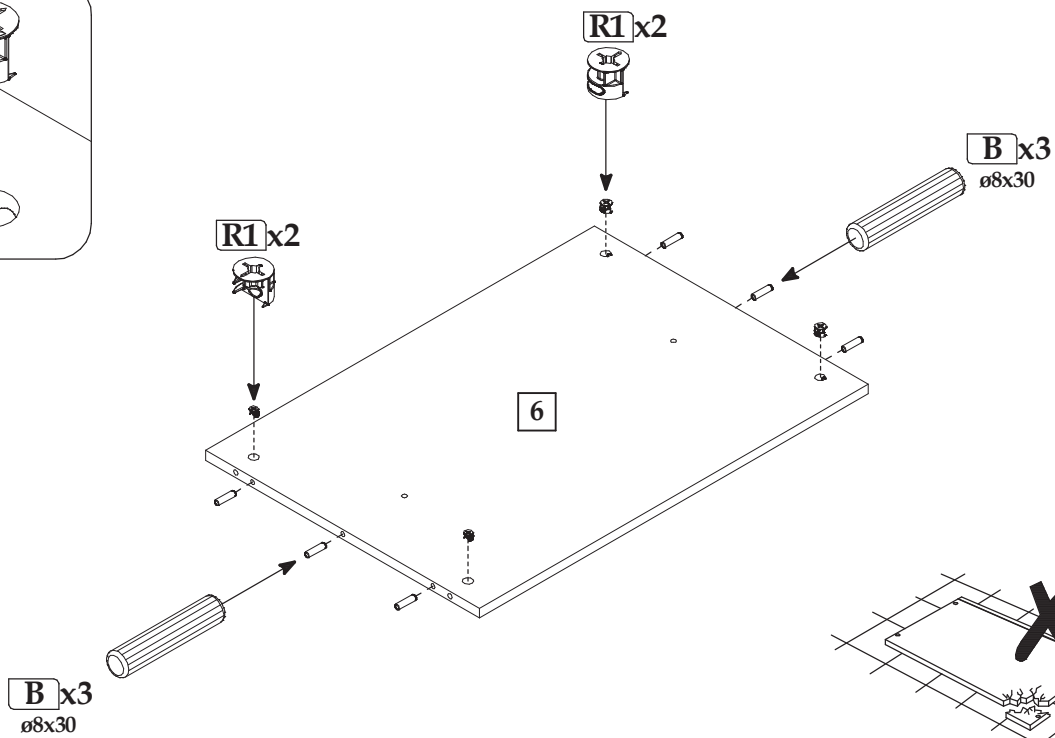
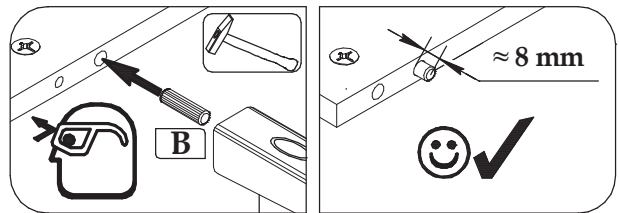
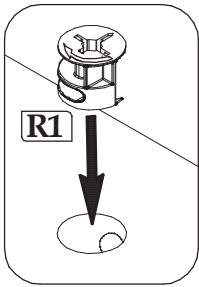

▶ 5

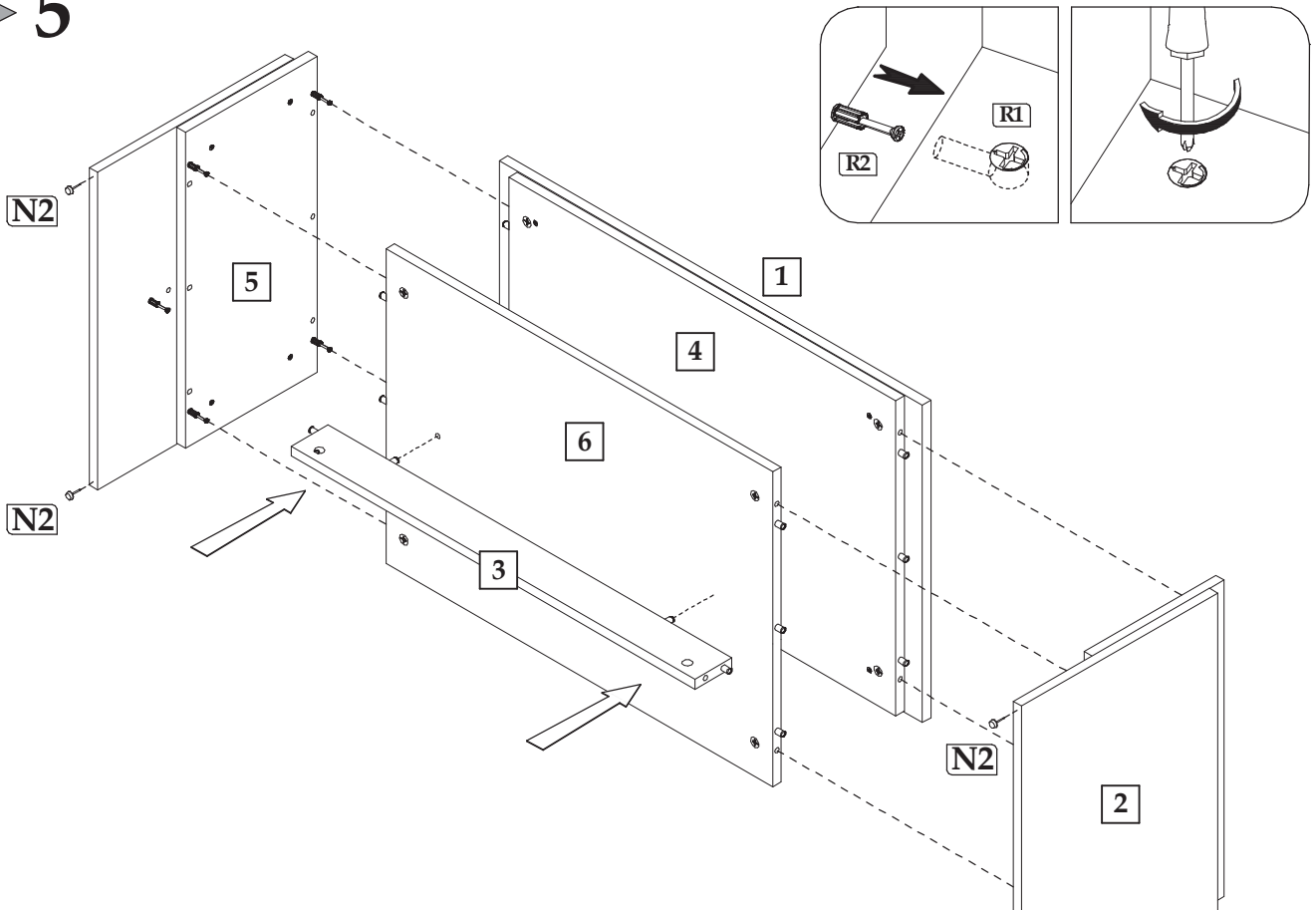

▶ 6

