

# SINTRA

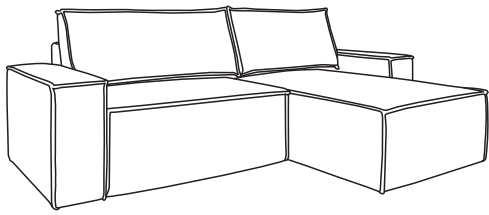

P

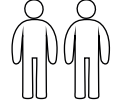
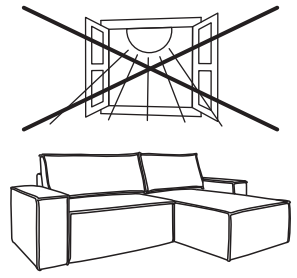
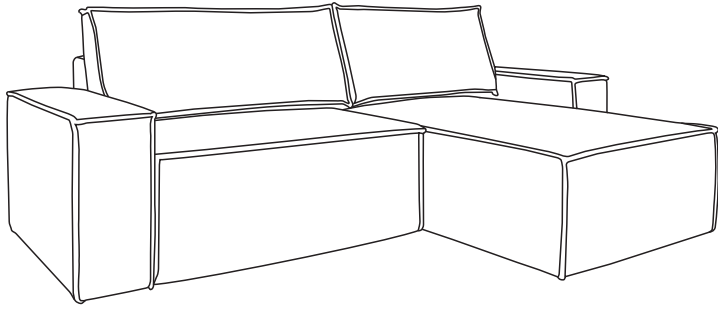
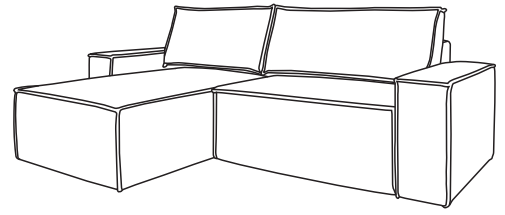

L

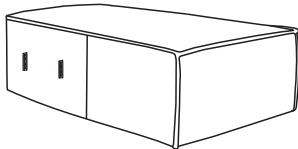
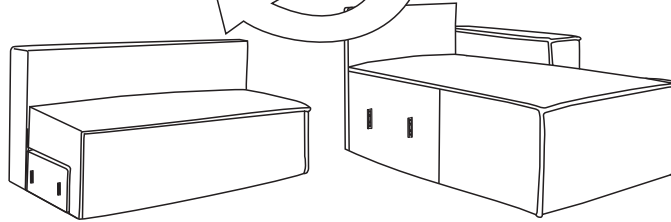

A x1

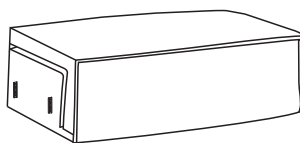

B x1



C x1

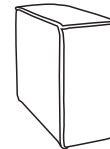

D x1

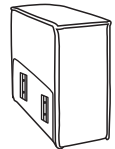

E x1

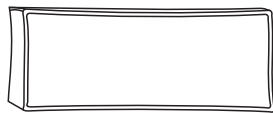

F x1

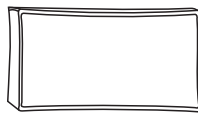

G x1



H x1

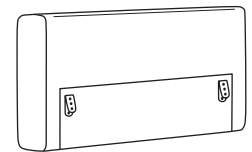

I x1

1

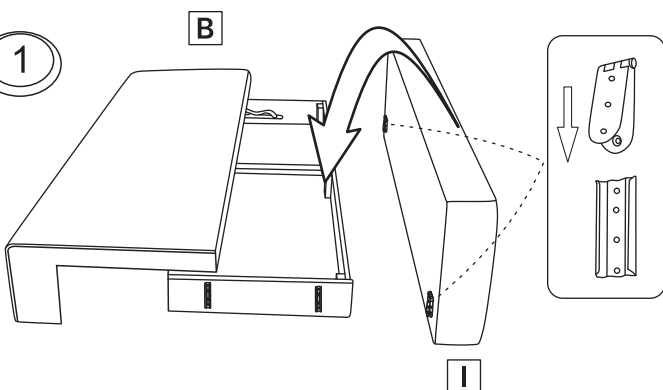

2

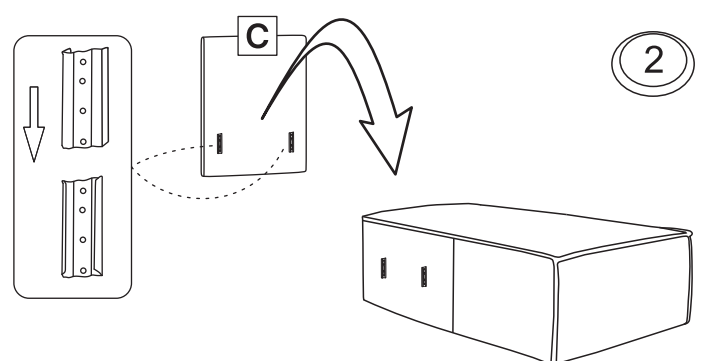

3

P

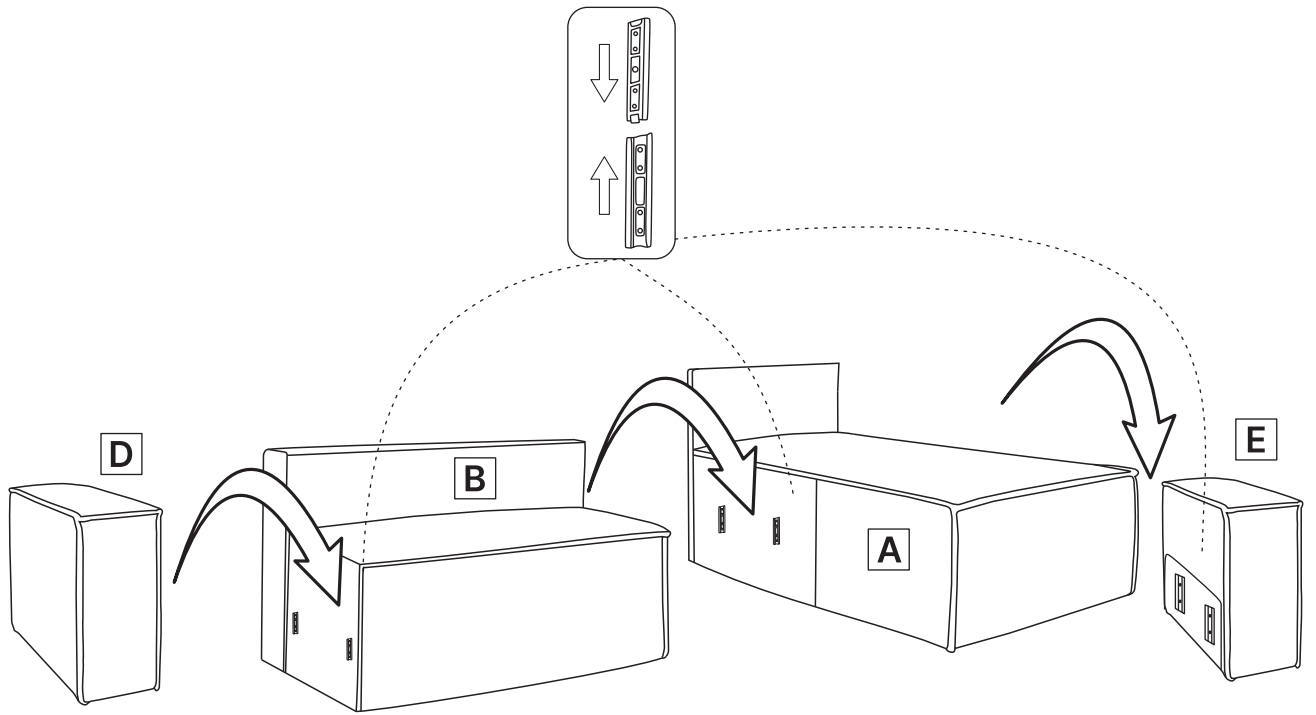

4

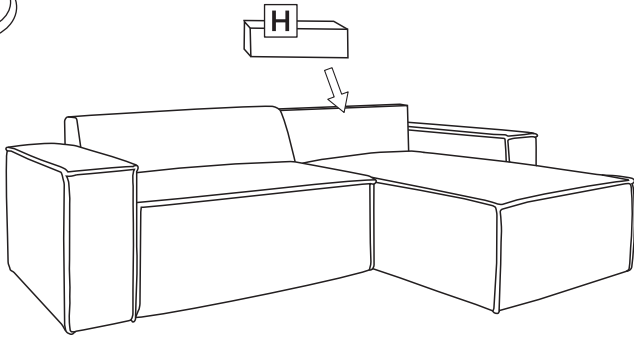

5

