

WITRYNA MALMO

(1920x800x428mm)

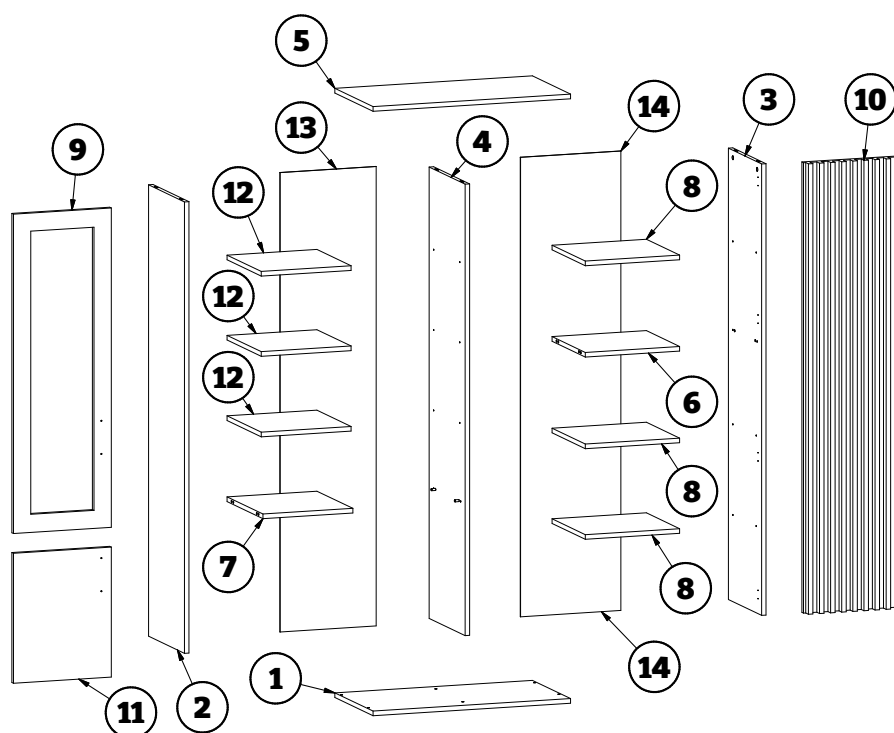
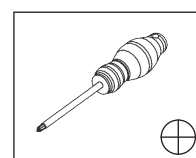
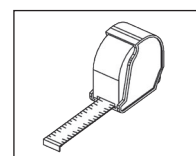
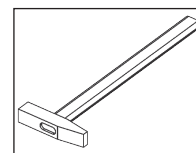
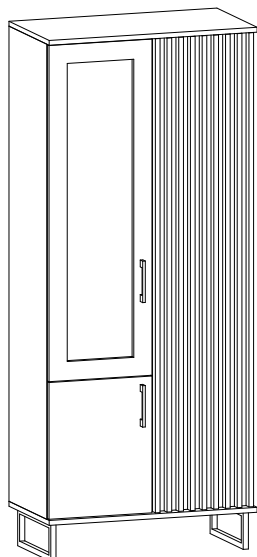

① **x1** 800x425x18mm

② **x1** 1744x400x18mm

③ **x1** 1744x370x18mm

④ **x1** 1744x400x18mm

⑤ **x1** 800x425x18mm

⑥ **x1** 381x370x18mm

⑦ **x1** 363x400x18mm

⑧ **x3** 381x365x18mm

⑨ **x1** 1234x395x18mm











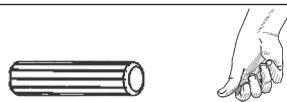

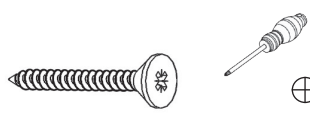





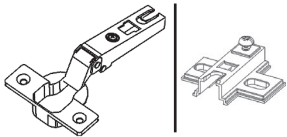



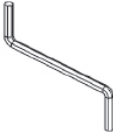

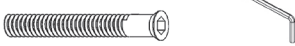





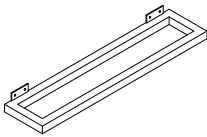

⑩ **x1** 1740x395x48mm

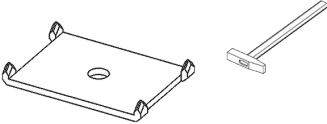
⑪ **x1** 503x395x18mm

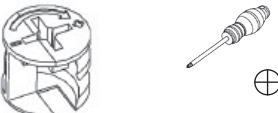
⑫ **x3** 363x380x18mm

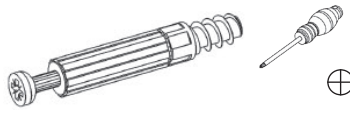
⑬ **x1** 1775x389x3mm

⑭ **x1** 1775x406x3mm

| | | |
|--|---|--|
|   <p>x 14 $\Phi 8 \times 35 \text{mm}$</p> |   <p>x 8 $\Phi 4 \times 20 \text{mm}$</p> |   <p>x 2</p> |
|   <p>x 4</p> |   <p>x 8</p> |   <p>x 16 $\Phi 4 \times 16 \text{mm}$</p> |
|   <p>x 1</p> |   <p>x 6 7×50</p> |   <p>x 16 $\Phi 3,5 \times 16 \text{mm}$</p> |
|   <p>x 24</p> |   <p>x 66</p> |   <p>x 2</p> |
|   <p>x 12</p> |   <p>x 14</p> |   <p>x 14</p> |
|   <p>x 14</p> |   <p>x 14 $\Phi 8 \times 35 \text{mm}$</p> | |

1

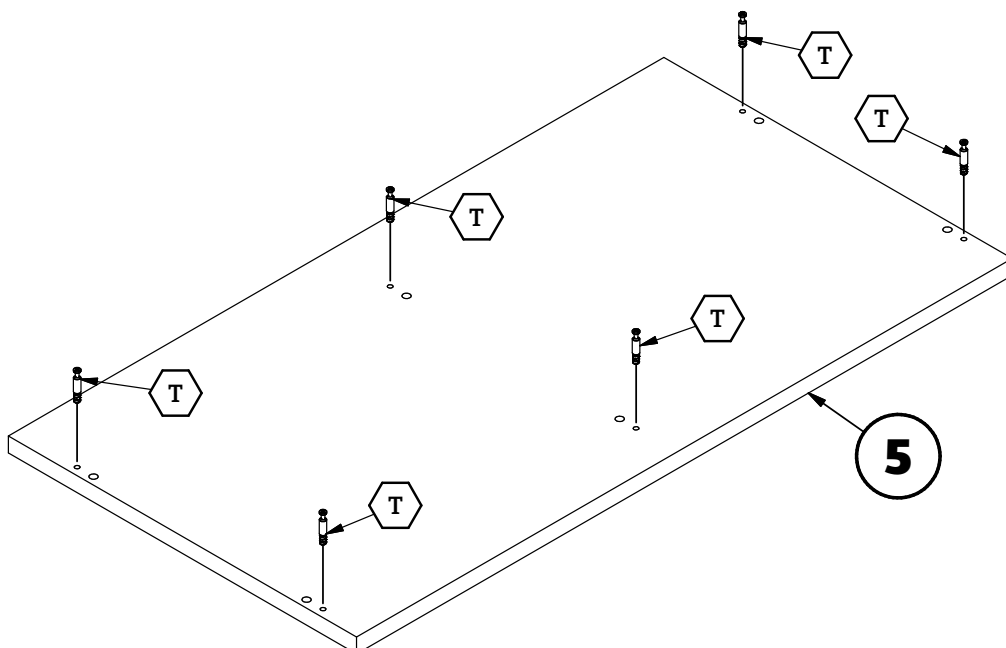
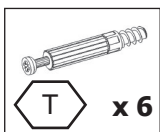

2

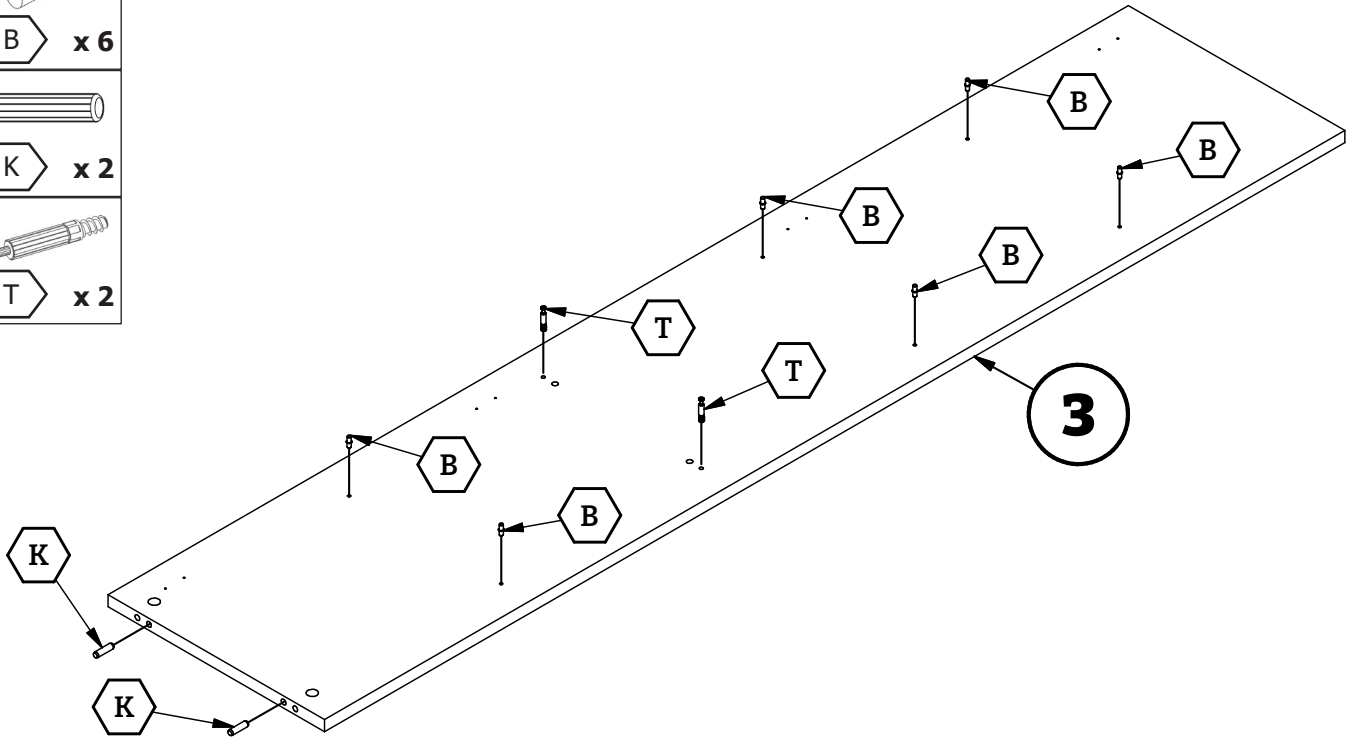
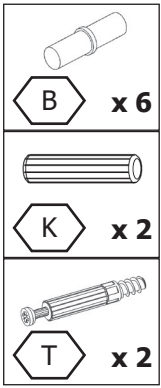

3

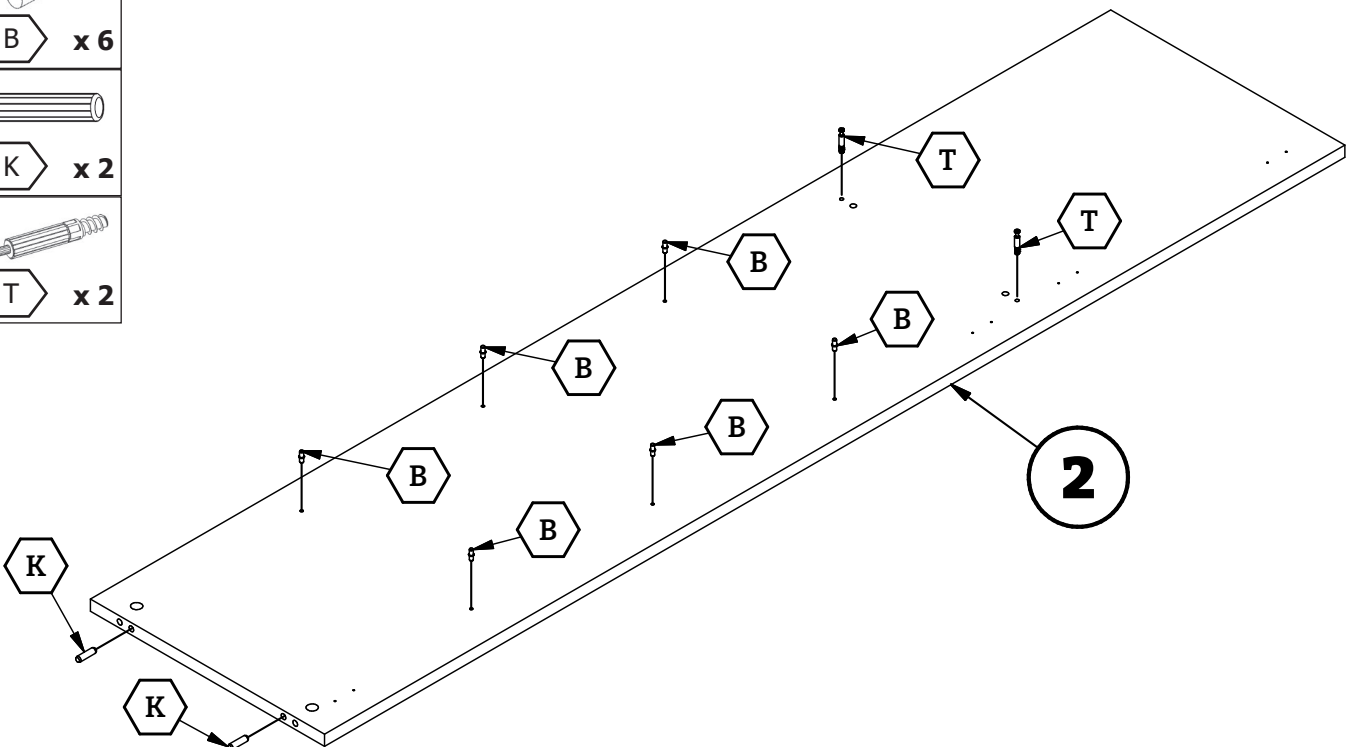
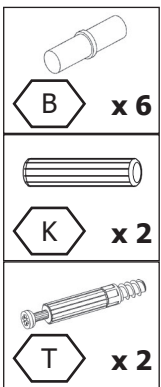

4

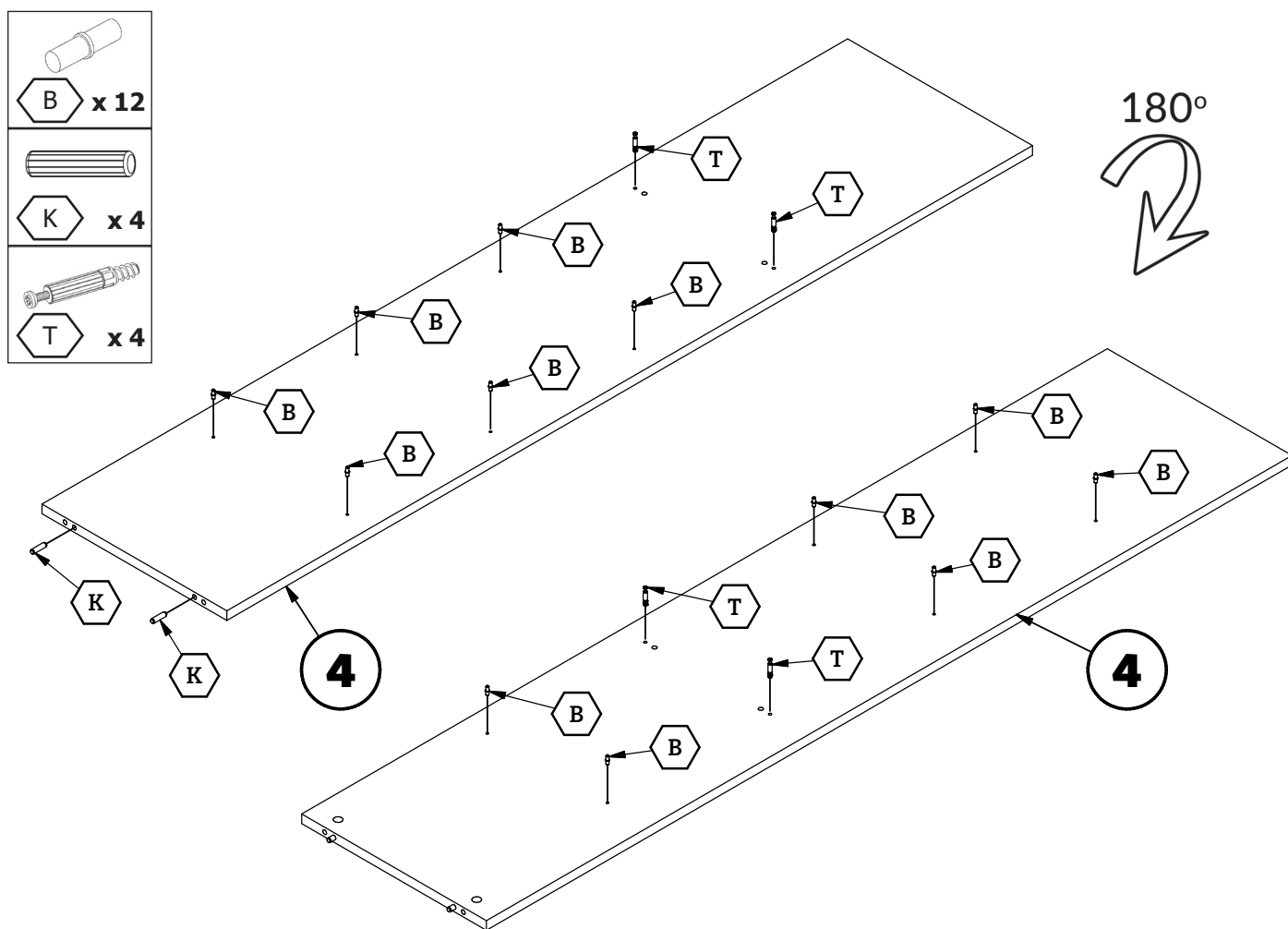

5

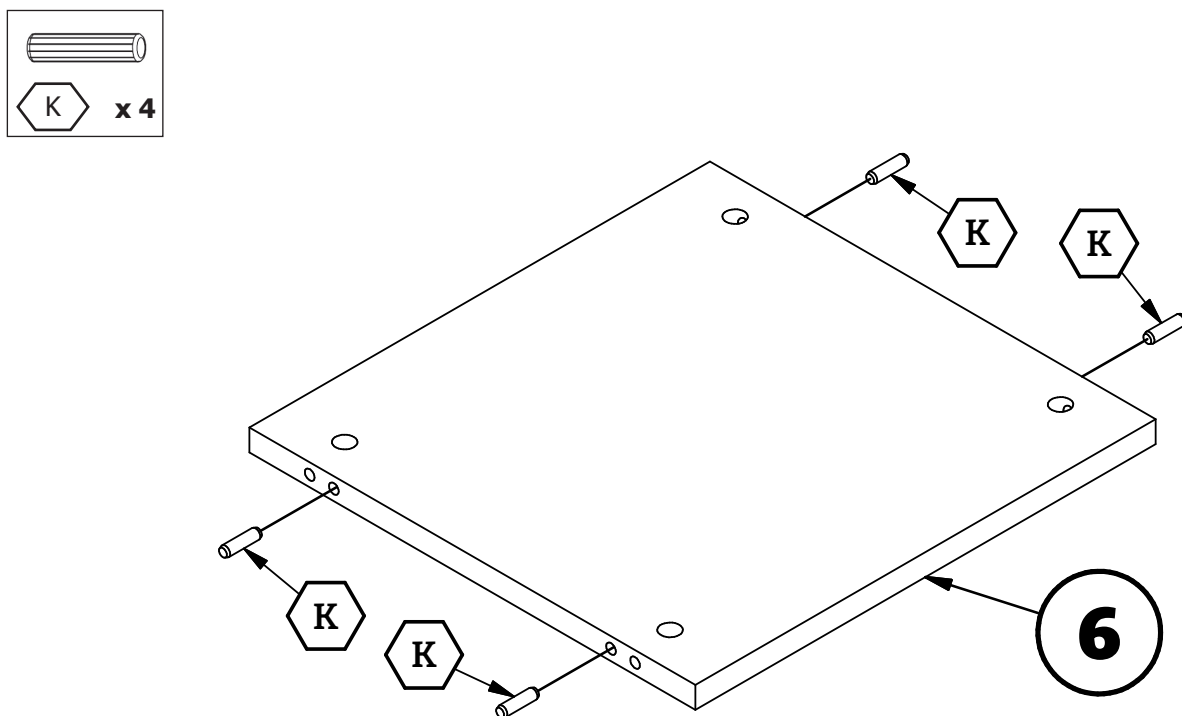

6

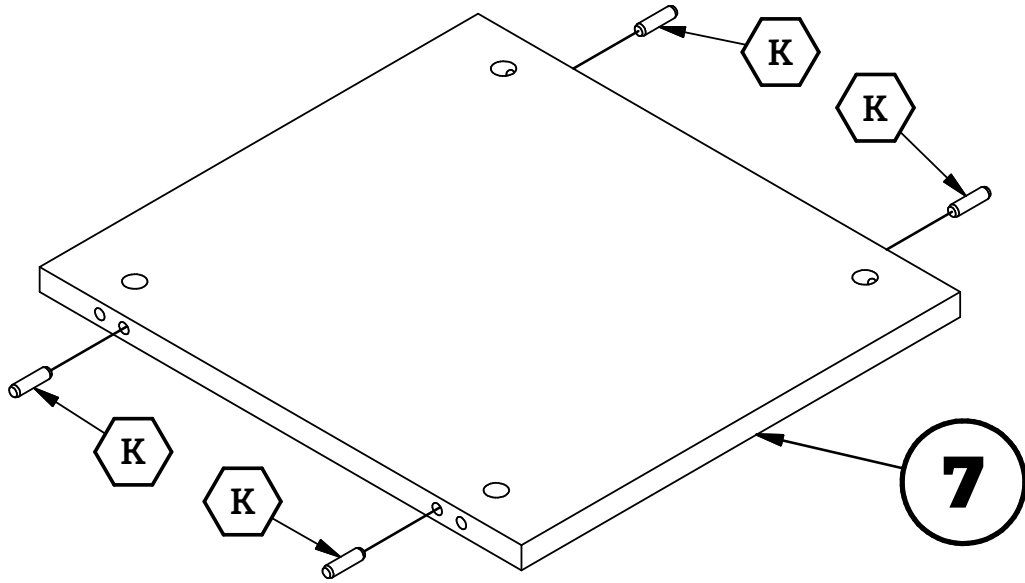
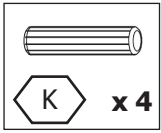

7

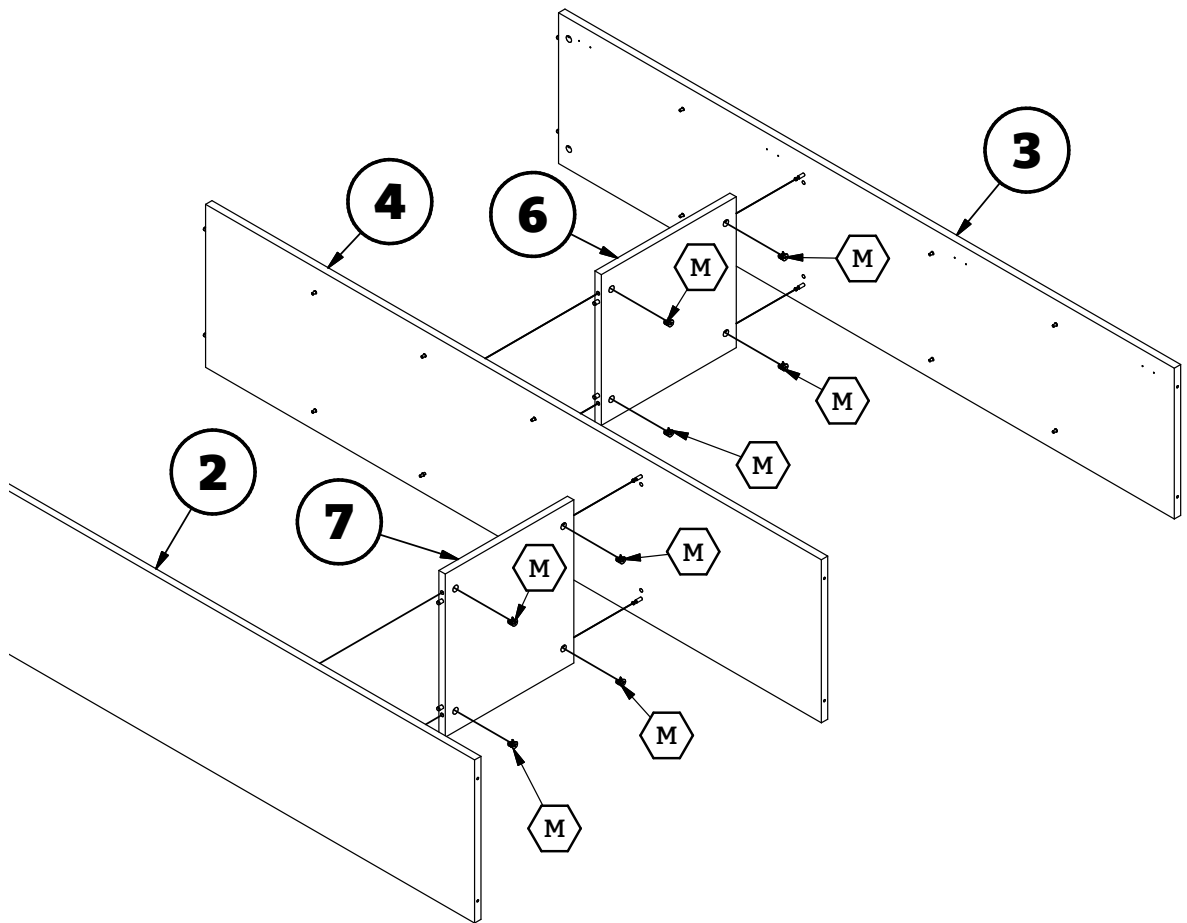
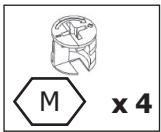

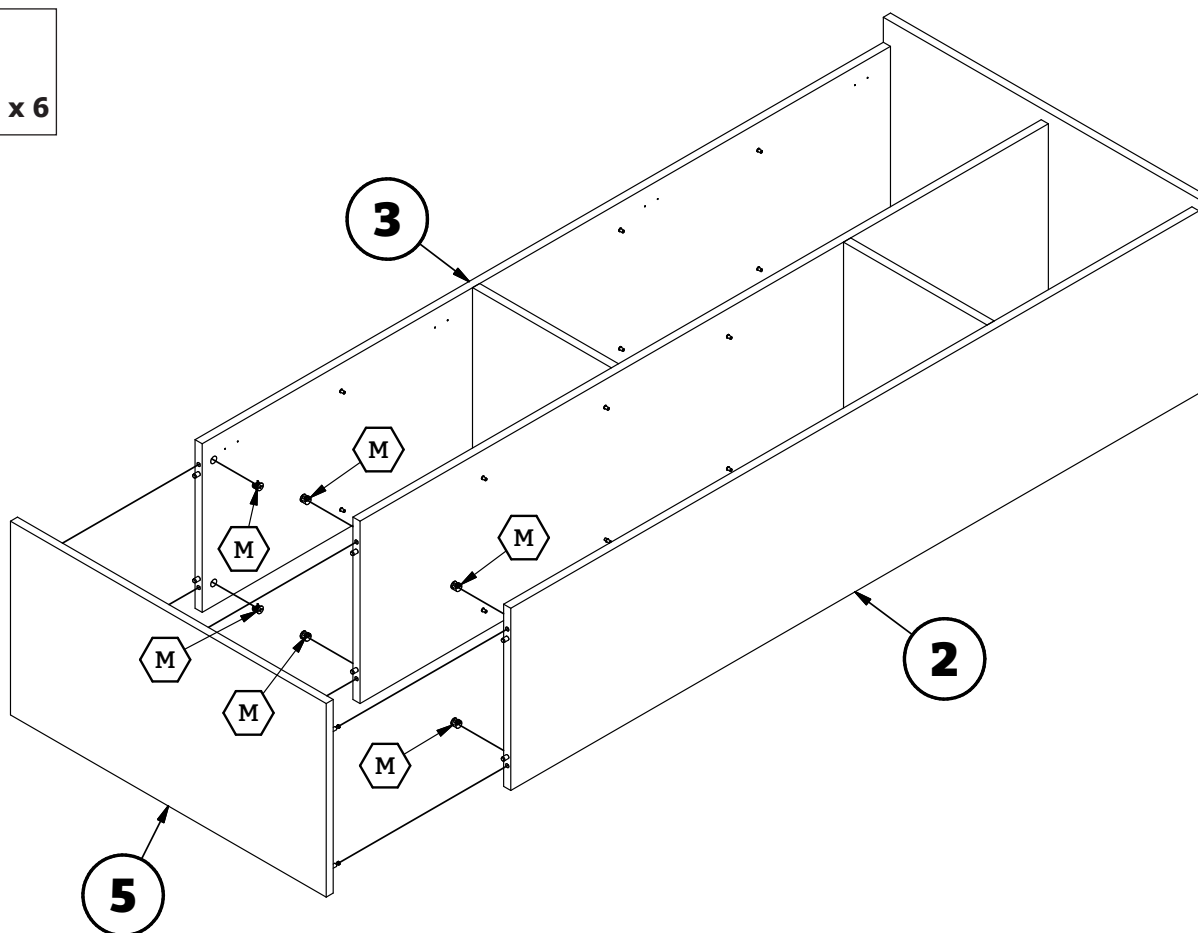
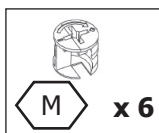
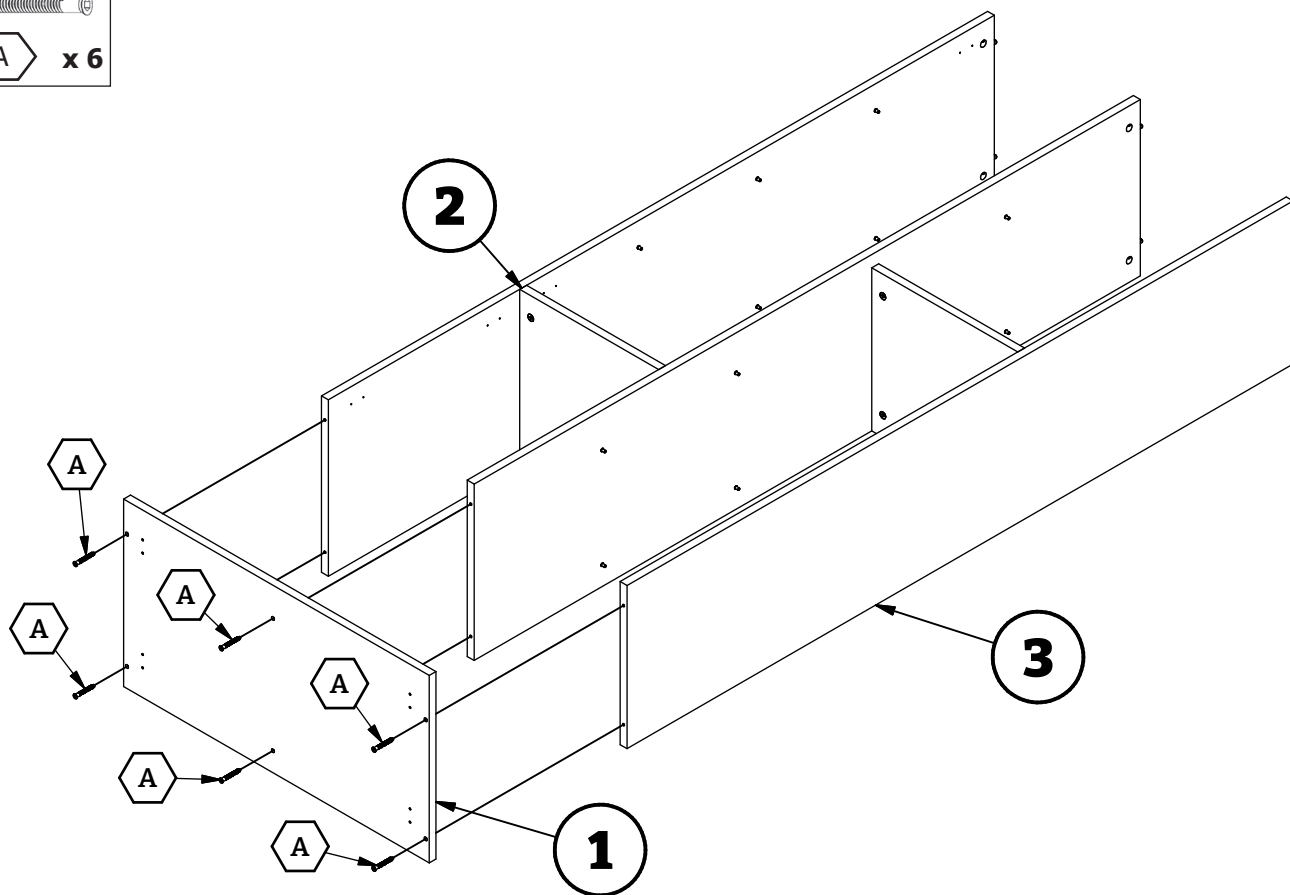
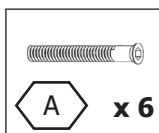

10

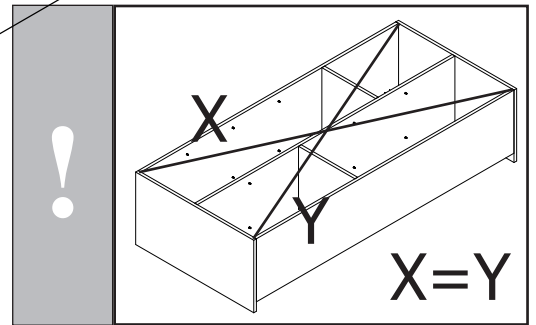
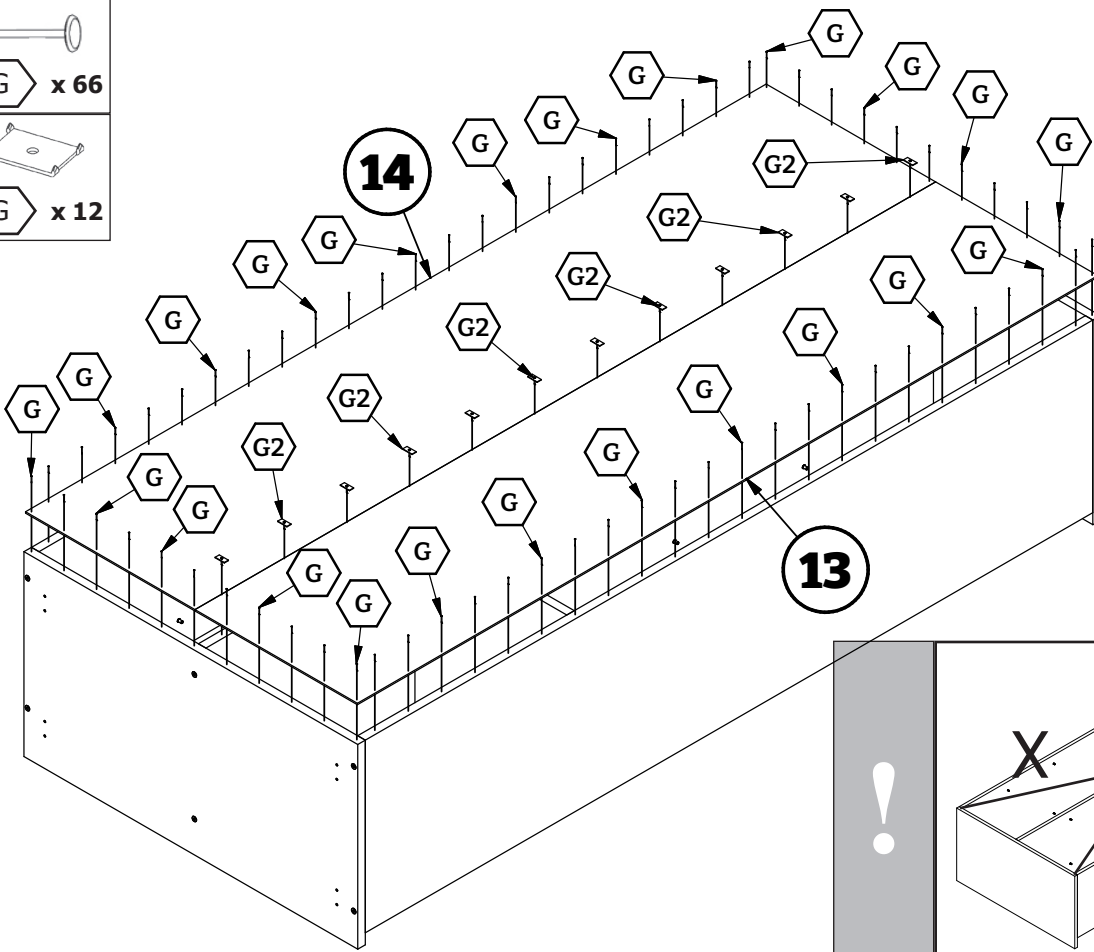
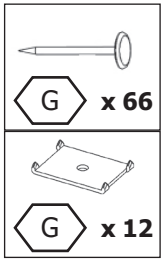

11

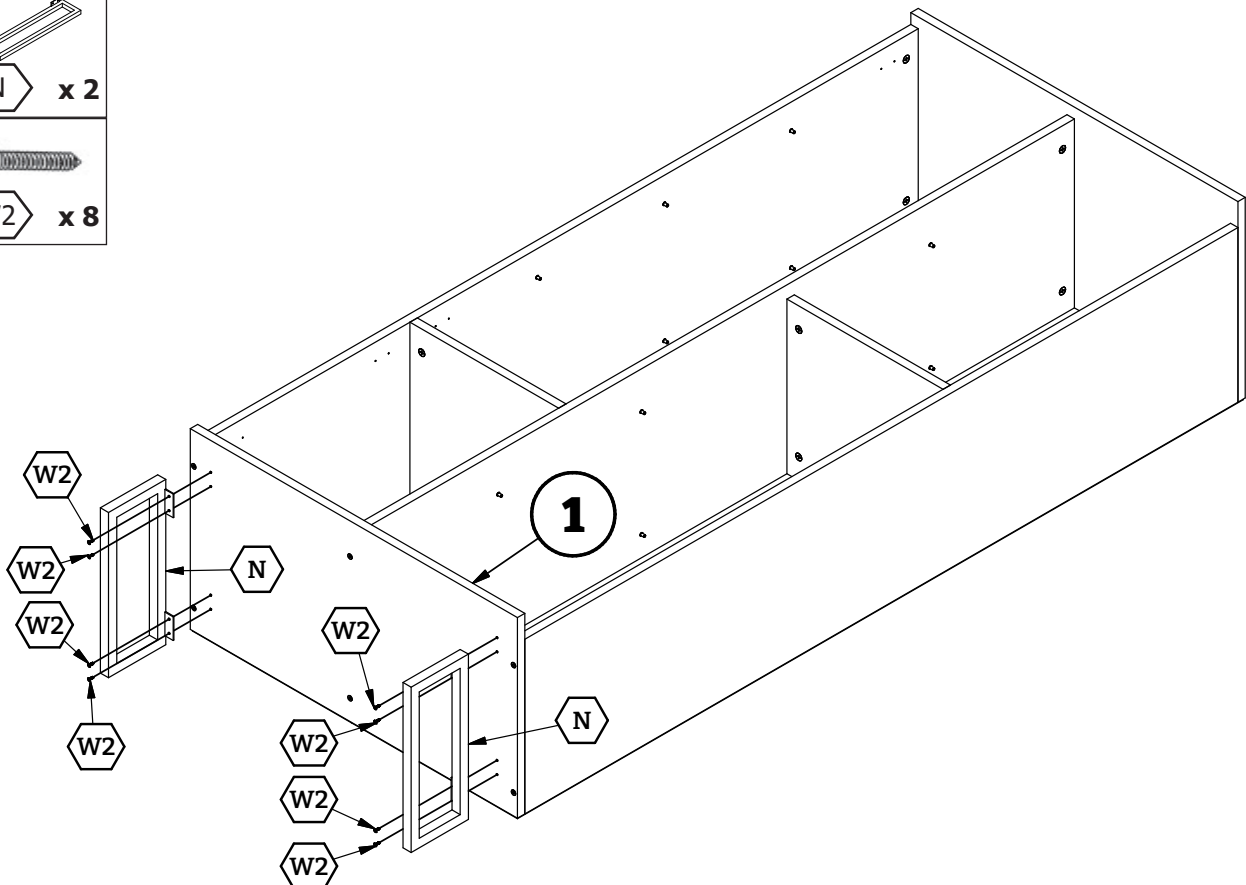
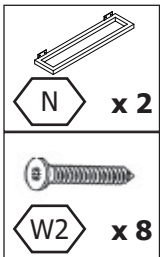

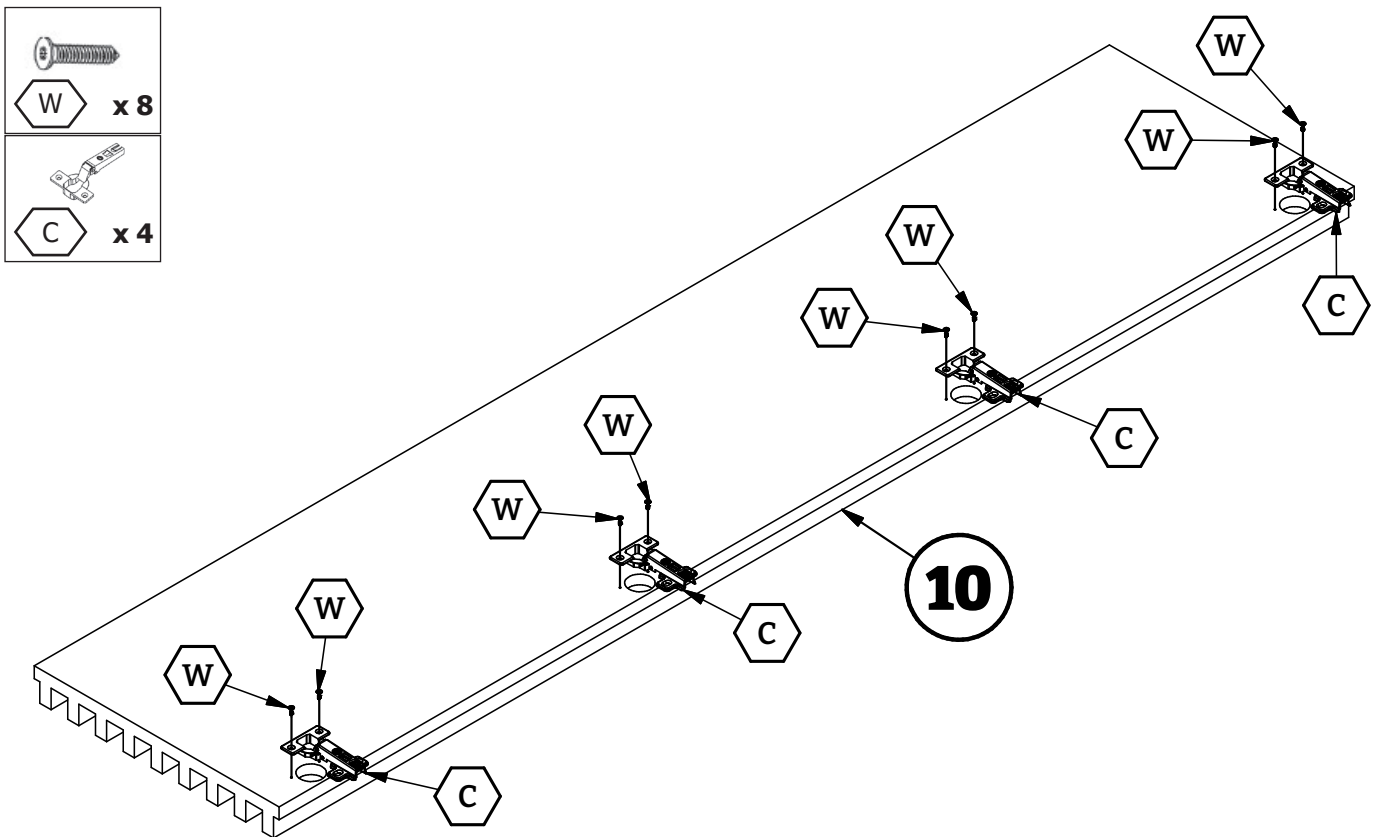
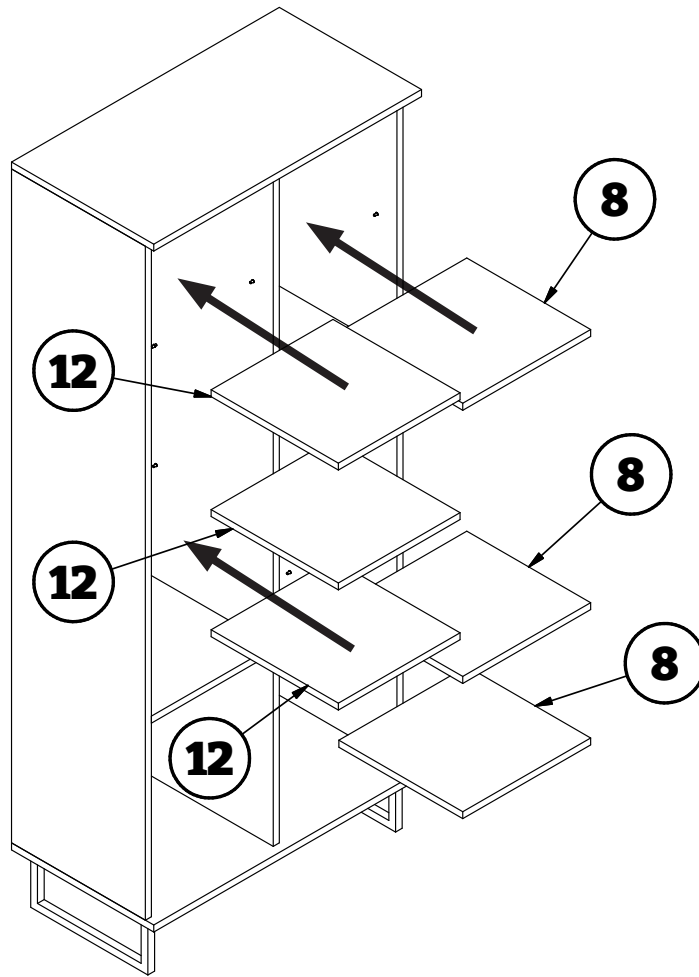

15

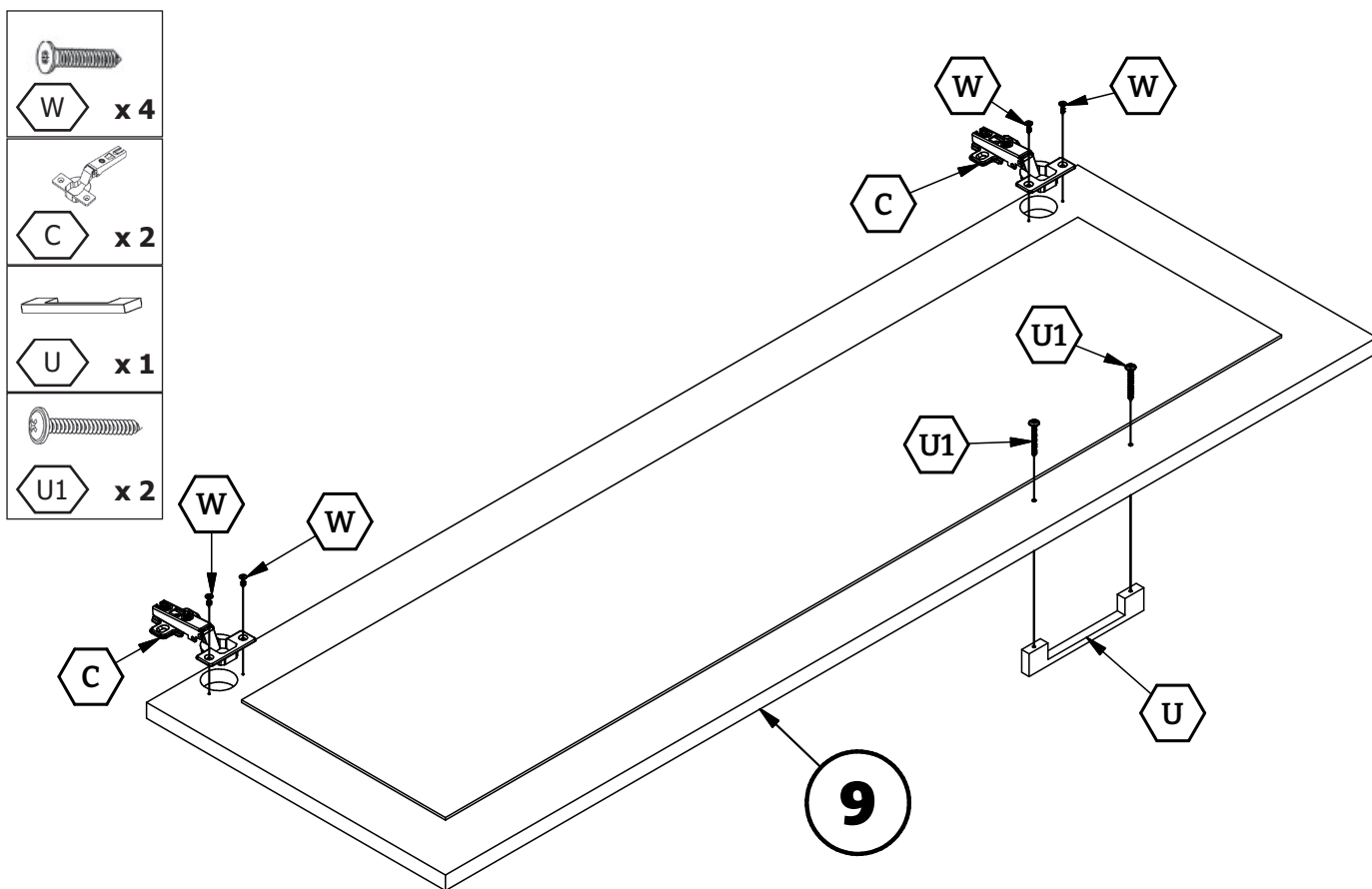

16

