

MALMO SZAFA

(800x1920x553mm)

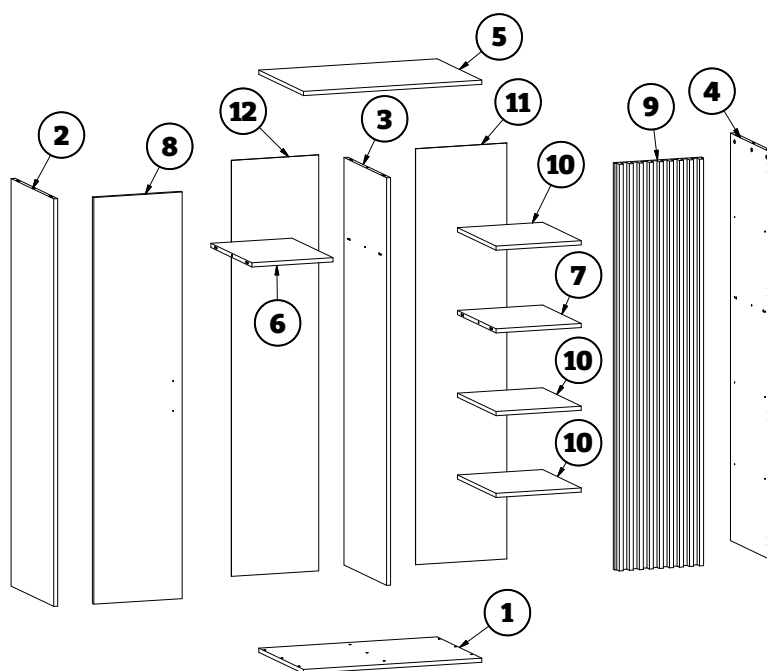
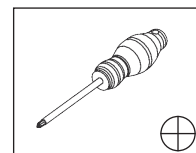
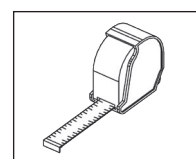
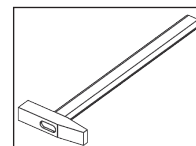
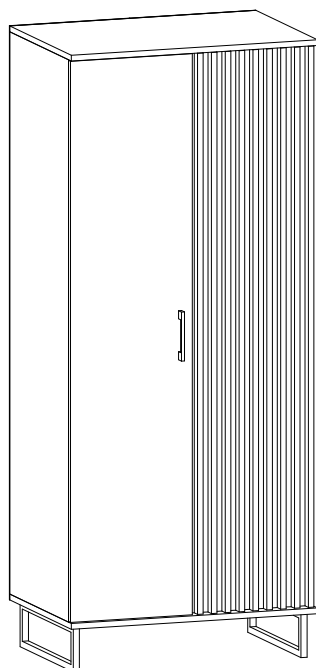

① **x1** 800x550x18mm

② **x1** 1744x525x18mm

③ **x1** 1744x525x18mm

④ **x1** 1744x495x18mm

⑤ **x1** 800x550x18mm

⑥ **x1** 363x505x18mm

⑦ **x1** 381x475x18mm





















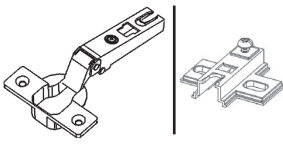



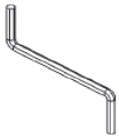

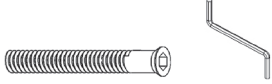



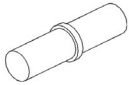



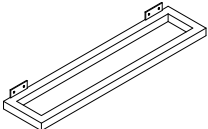

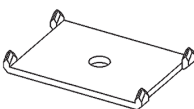
⑧ **x1** 1740x395x18mm

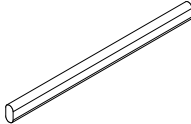
⑨ **x1** 1740x395x48mm

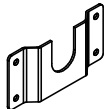
⑩ **x3** 381x475x18mm

⑪ **x1** 1780x409x3mm

⑫ **x1** 1780x391x3mm

   <p>x 14 $\Phi 8 \times 35 \text{mm}$</p>	  <p>x 8 $\Phi 4 \times 20 \text{mm}$</p>	  <p>x 1</p>
  <p>x 2</p>	  <p>x 8</p>	  <p>x 16 $\Phi 4 \times 16 \text{mm}$</p>
  <p>x 1</p>	  <p>x 9 7×50</p>	  <p>x 24 $\Phi 3,5 \times 16 \text{mm}$</p>
   <p>x 12</p>	  <p>x 66</p>	  <p>x 2</p>
  <p>x 12</p>	  <p>x 1</p>	  <p>x 2</p>
  <p>x 21</p>	  <p>x 21</p>	  <p>x 21</p>

1

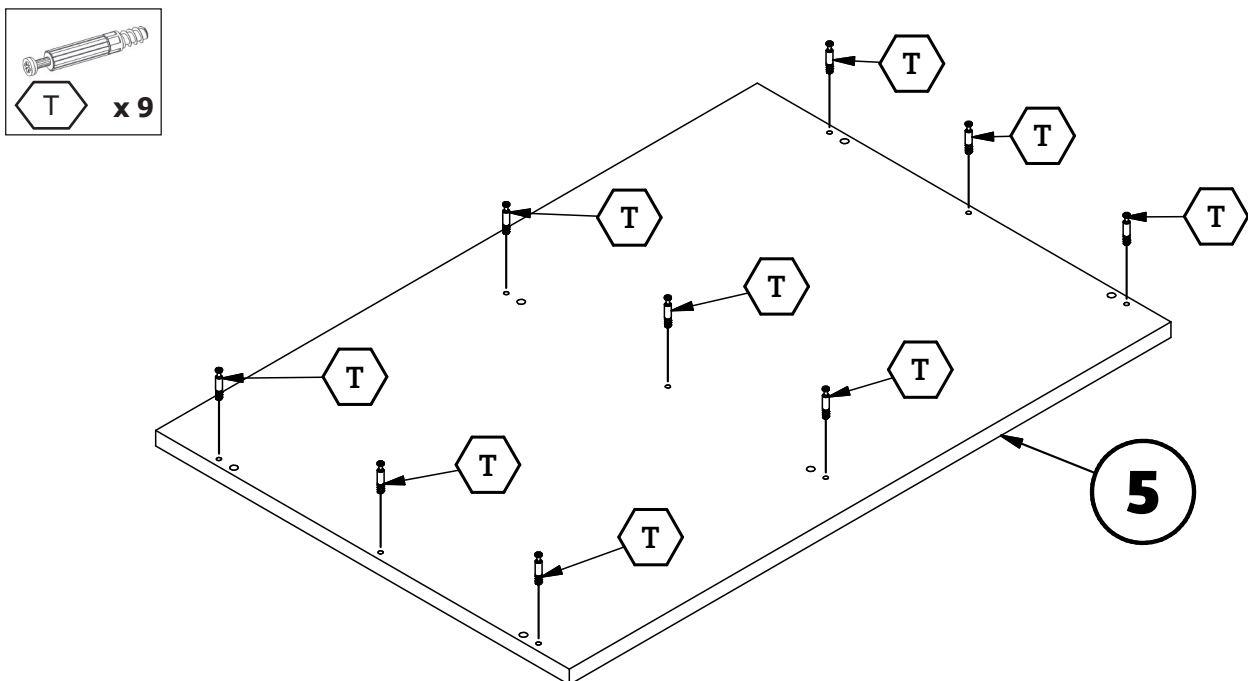

2

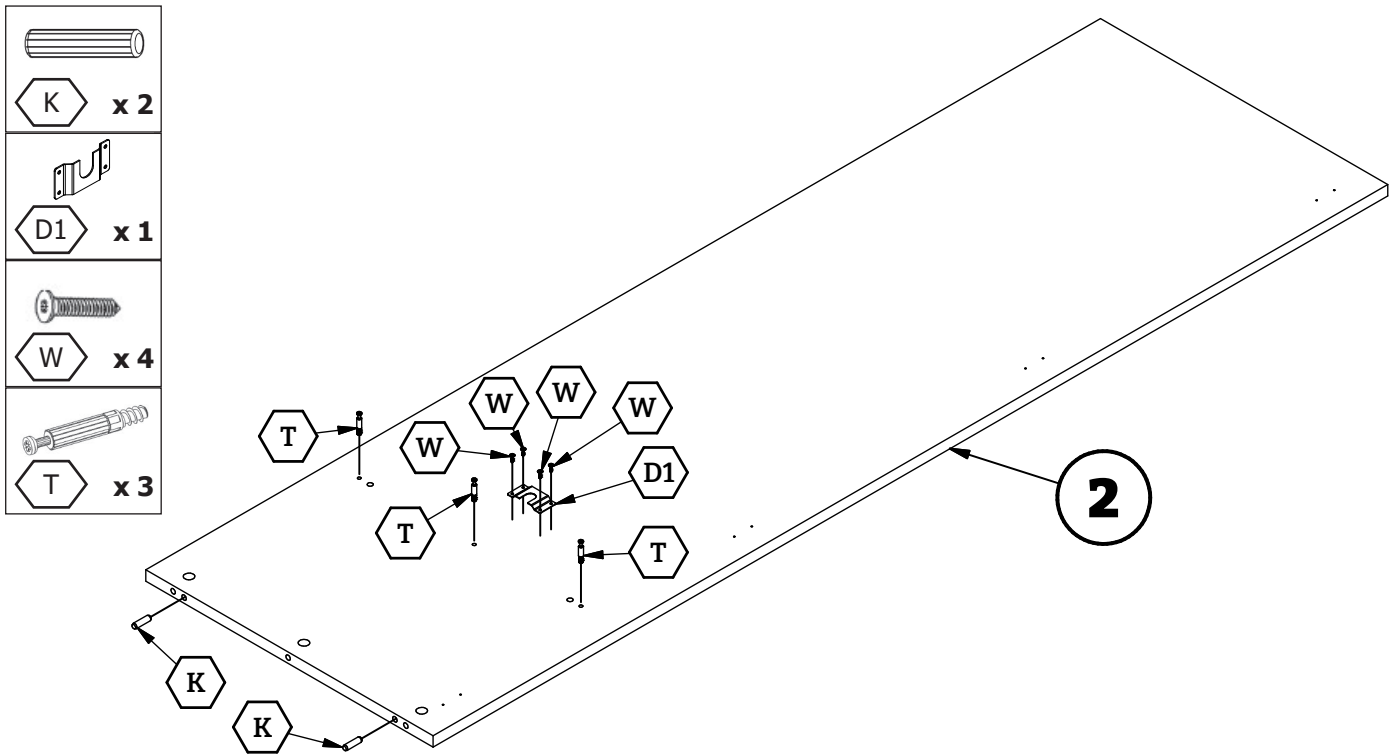

3

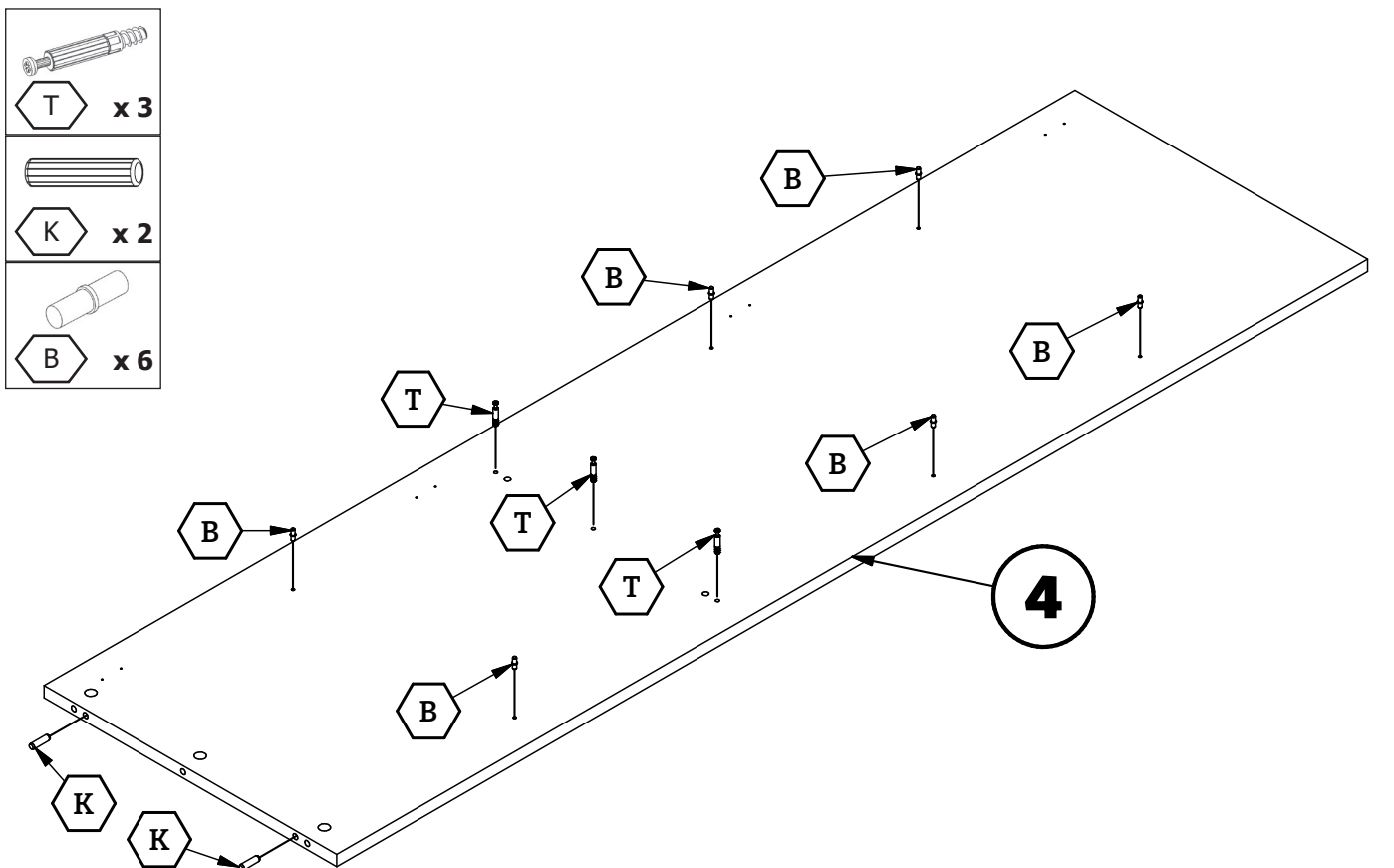

4

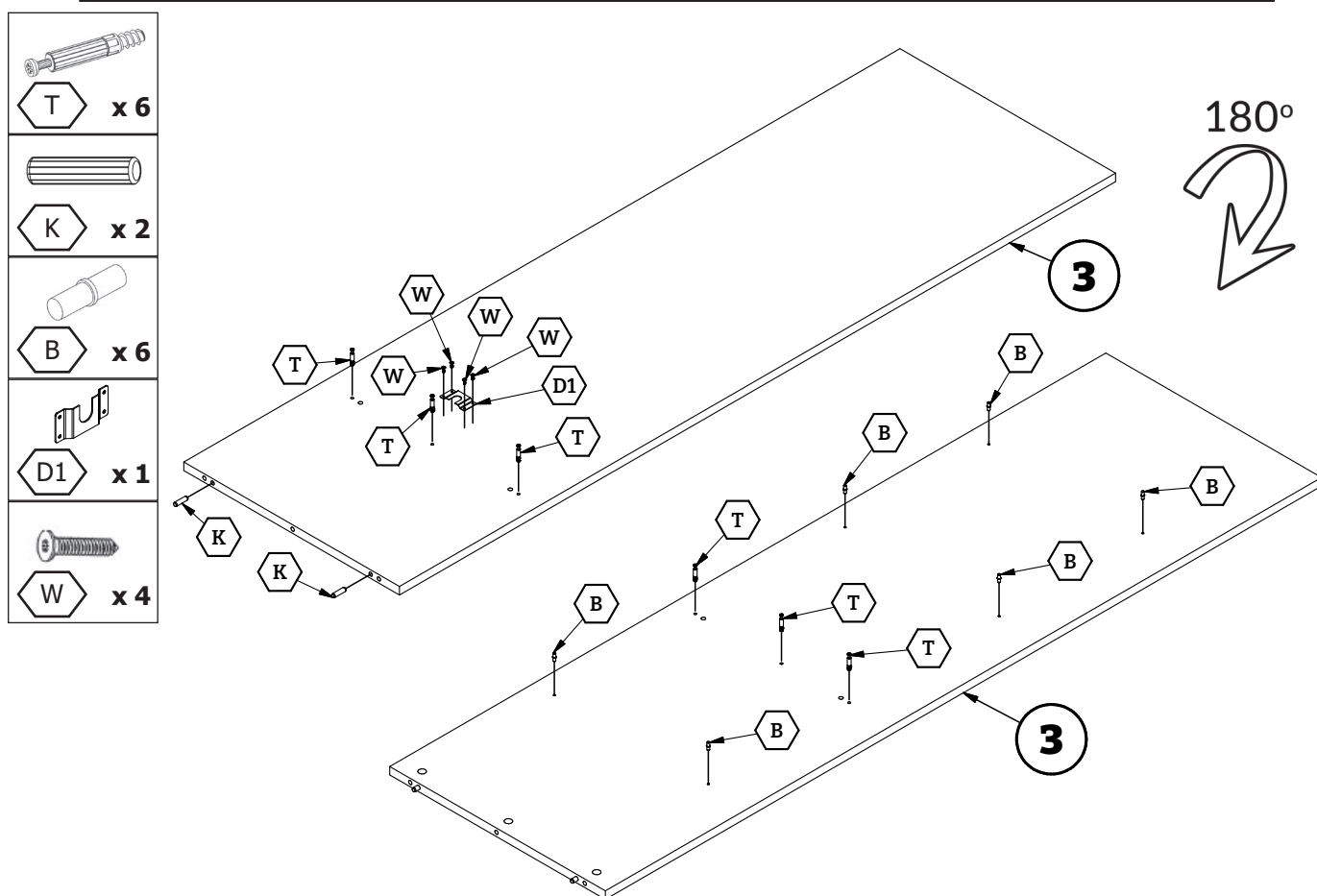

5

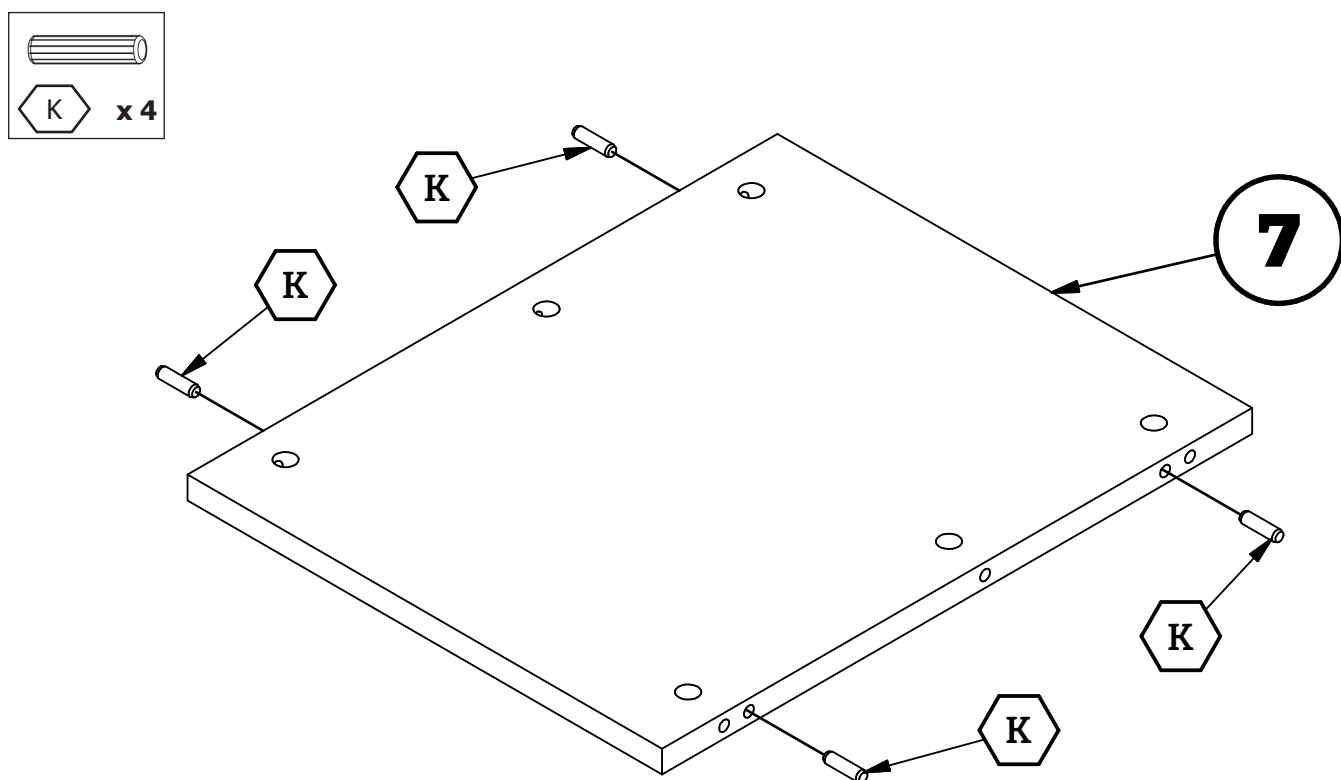

6

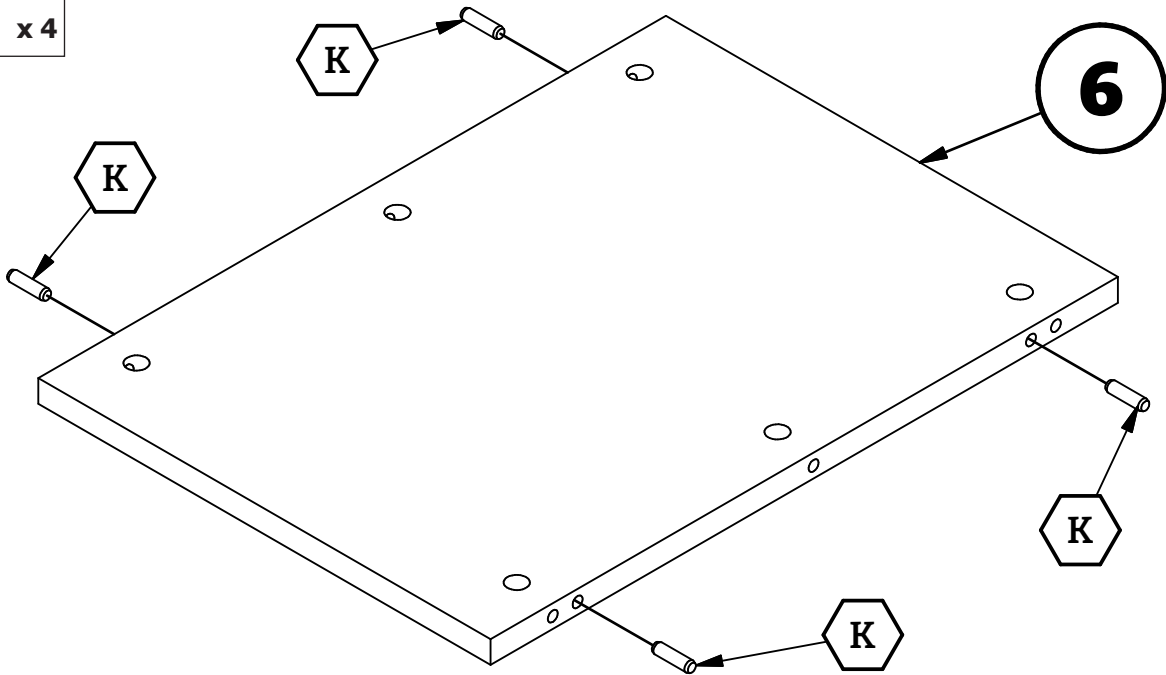
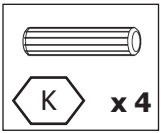

7

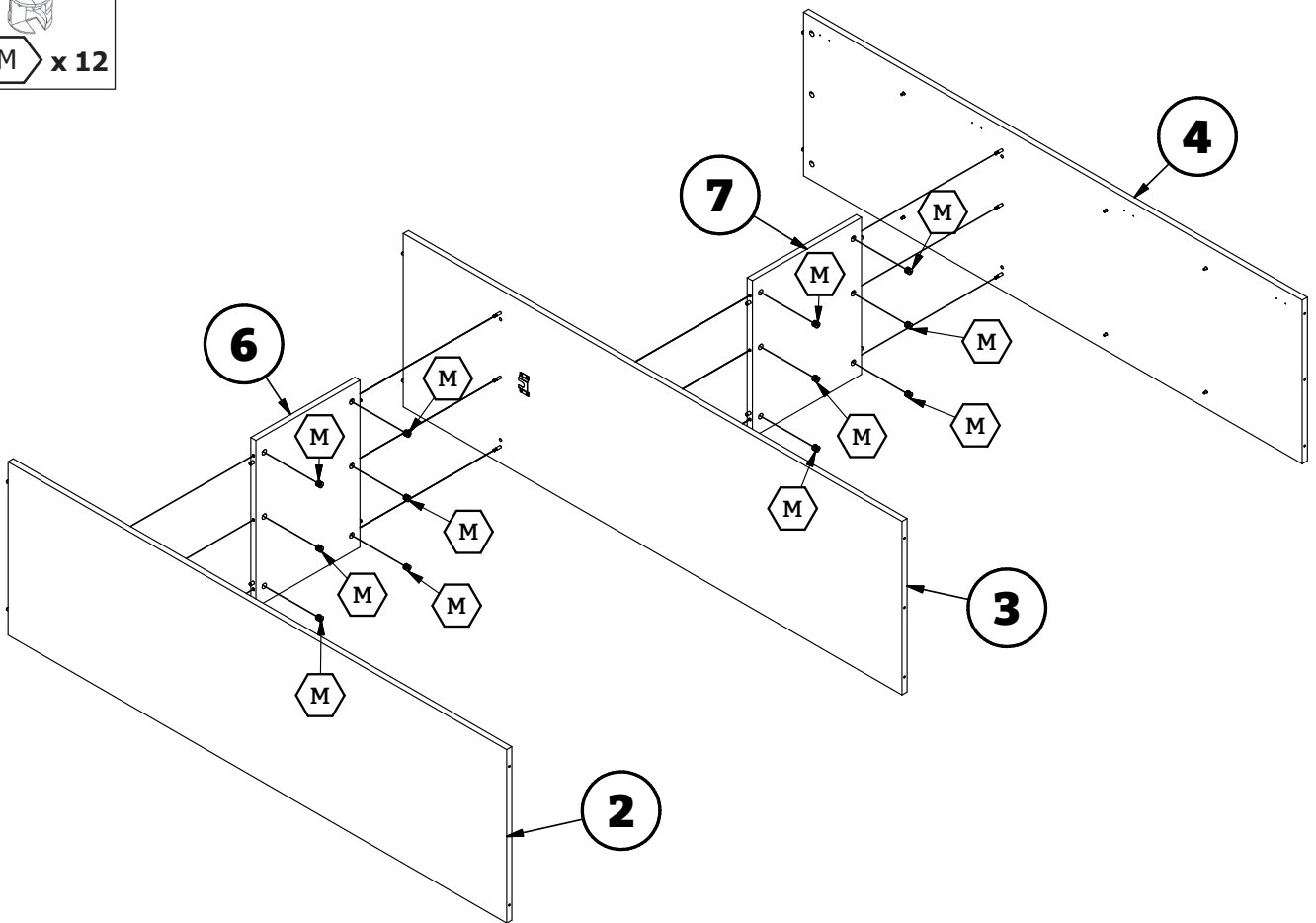
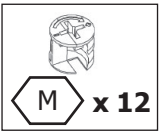

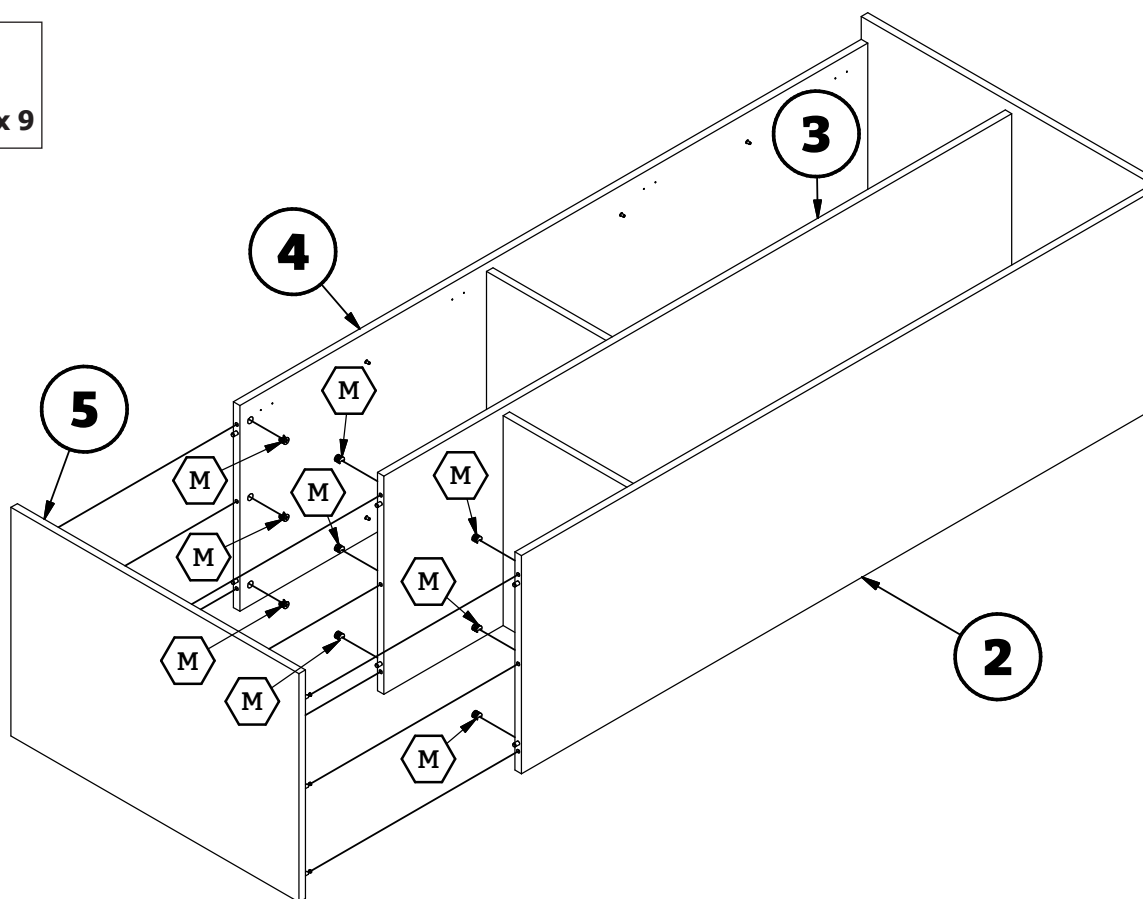
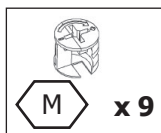
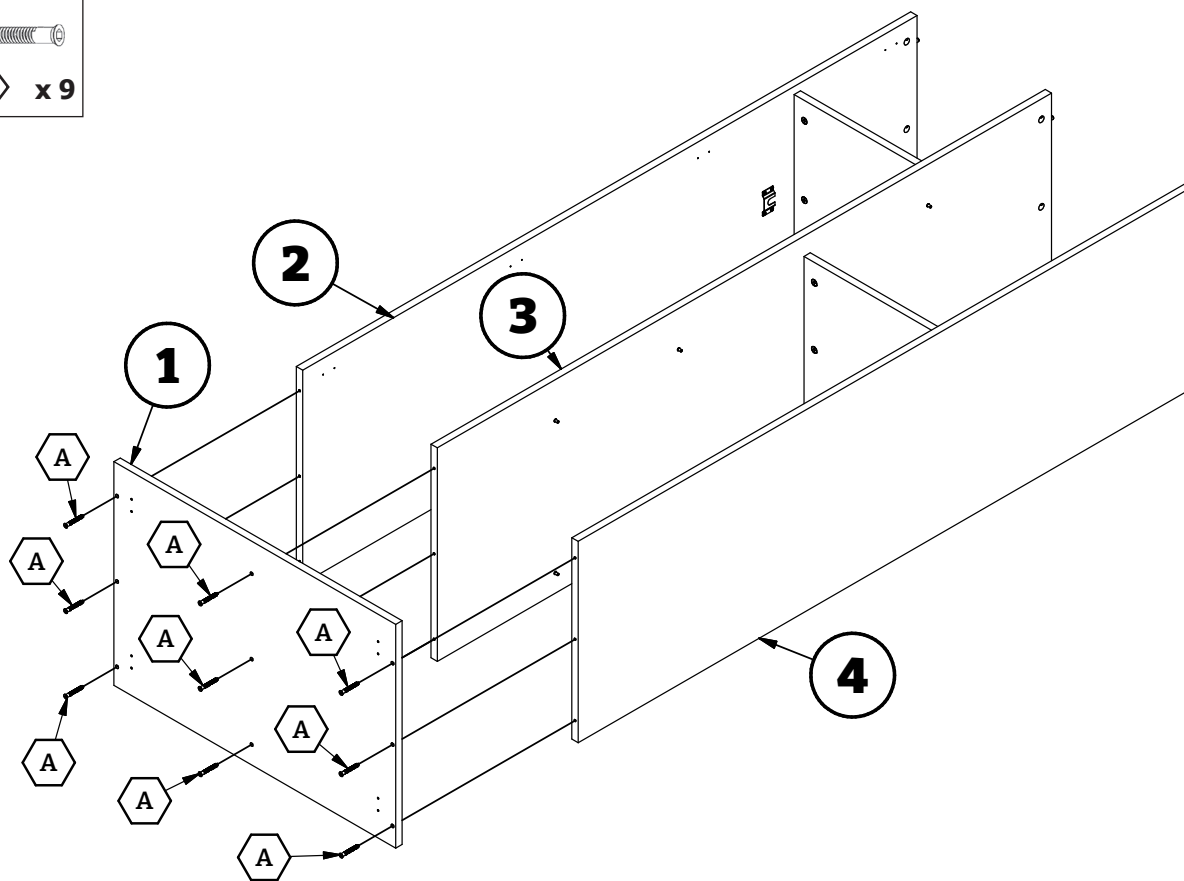
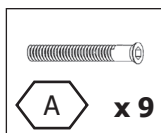

10

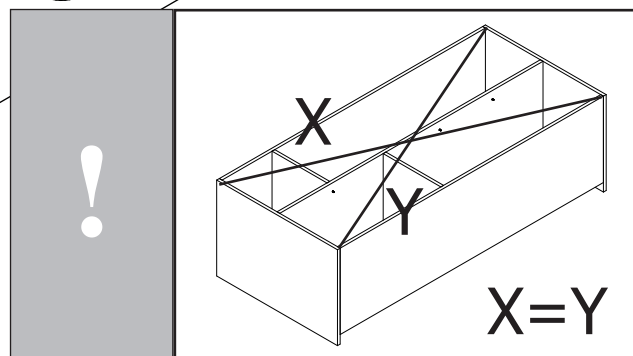
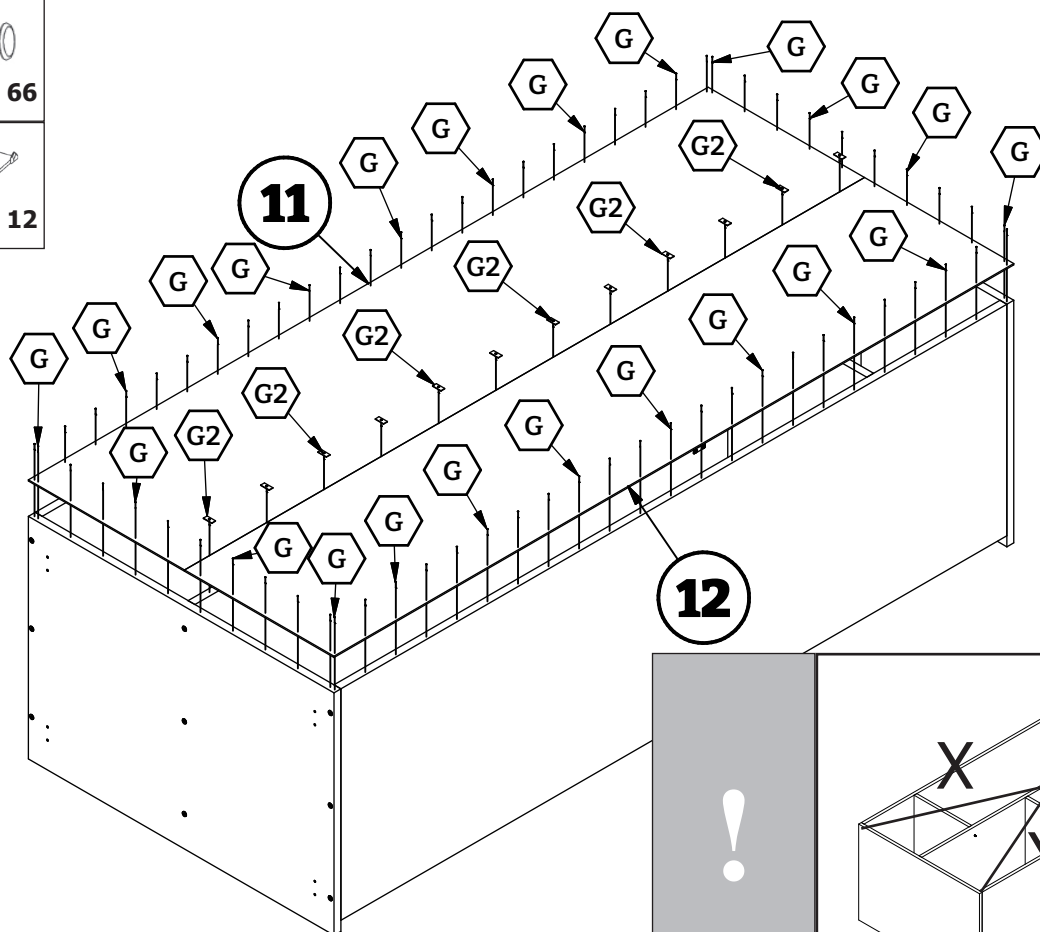
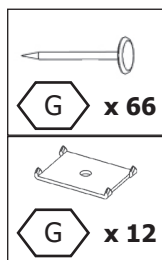

11

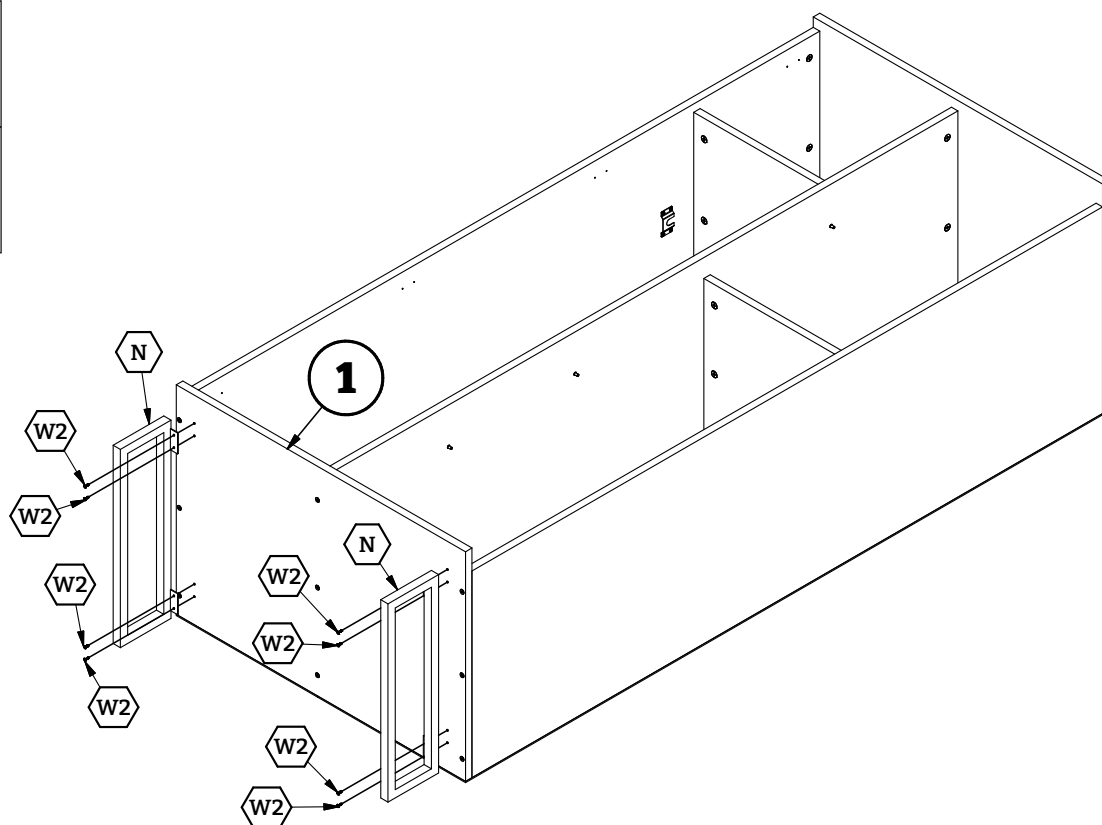
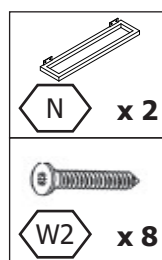



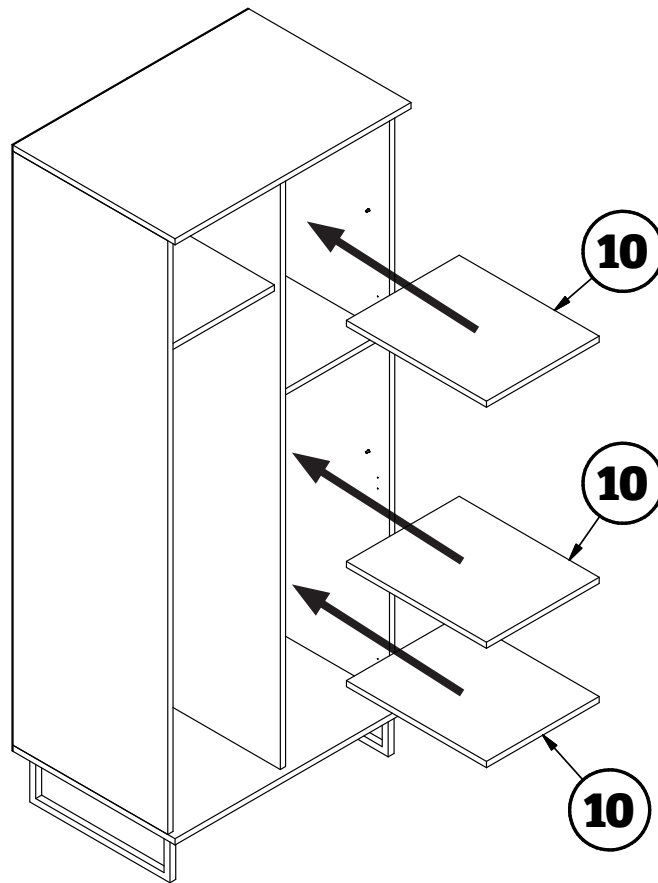

12

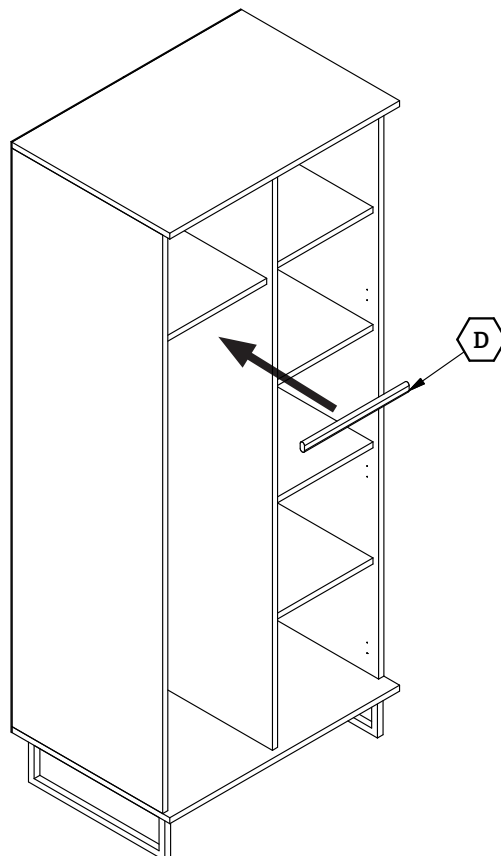

13



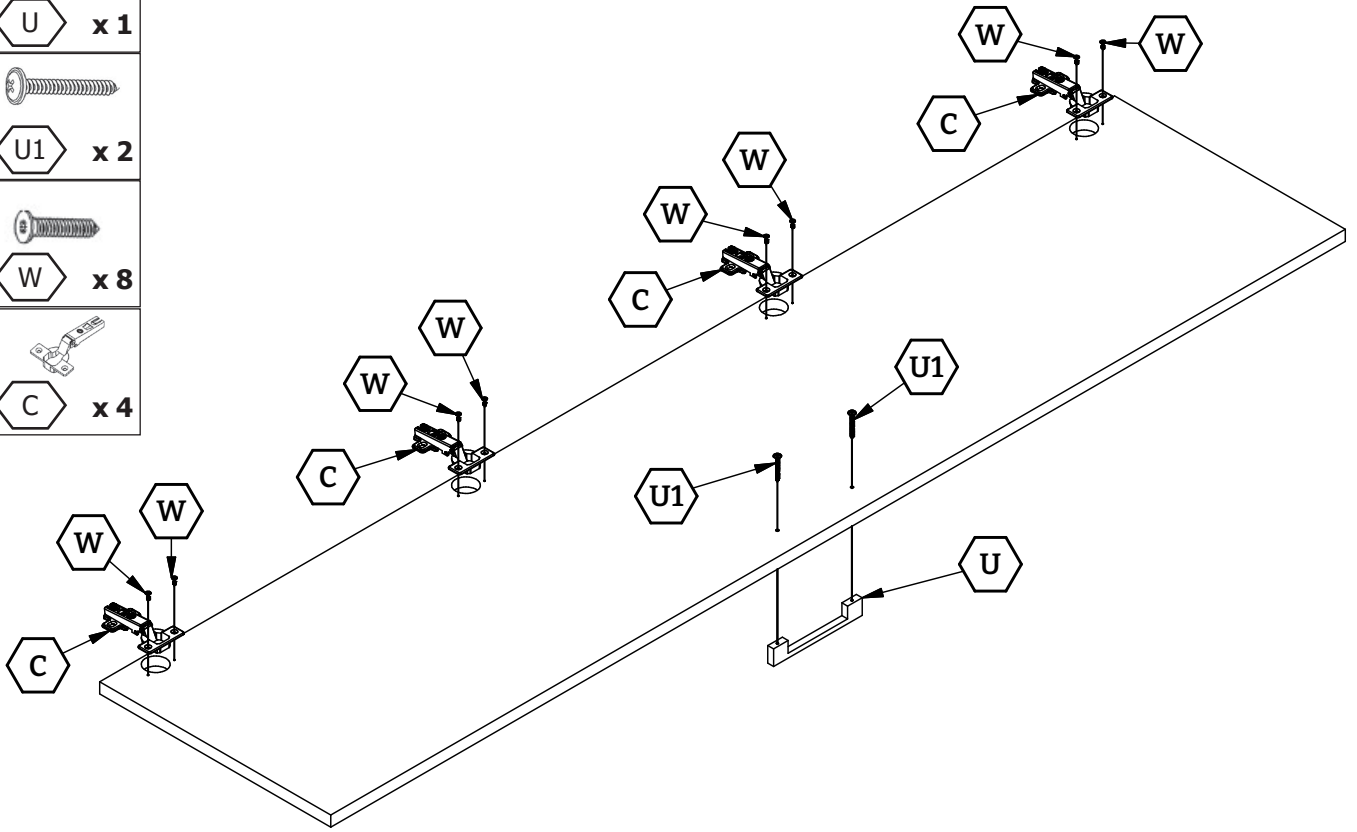

14

-  **U** x 1
-  **U1** x 2
-  **W** x 8
-  **C** x 4



15

-  **W** x 8
-  **C** x 4

