

# NORIDA

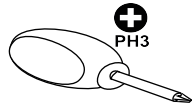

30min

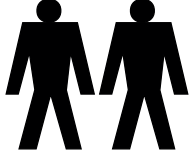

PH3

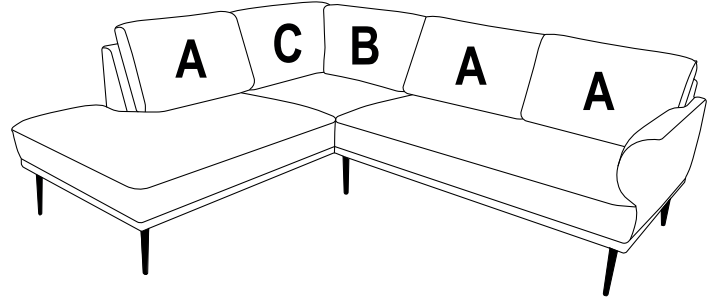
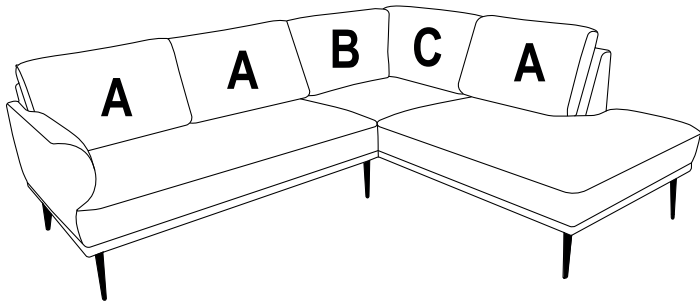

I

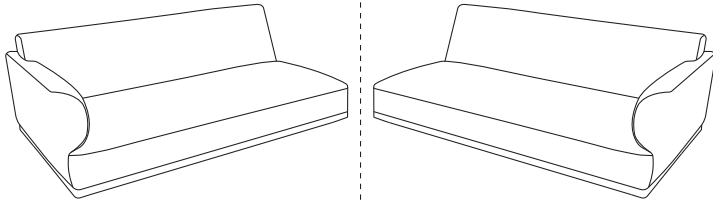

II

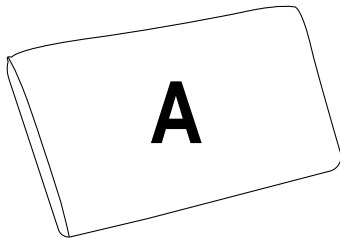
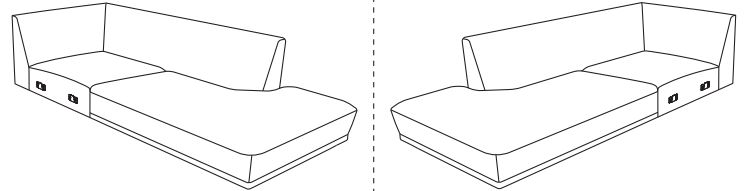

A

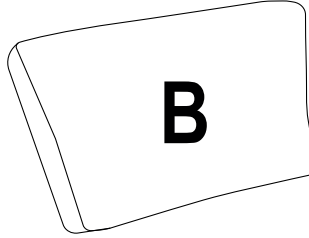

B

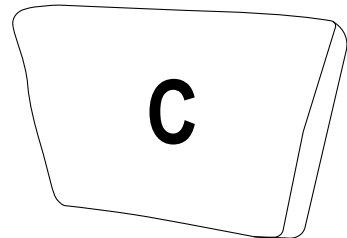

C

**Dx7**

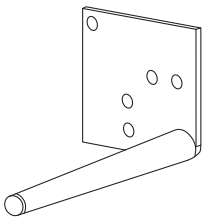

H=220 mm

**Ex21**

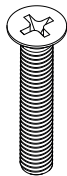

6x35



PH3

**Fx1**



H=145-230 mm

**Gx21**

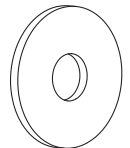

Ø6

1

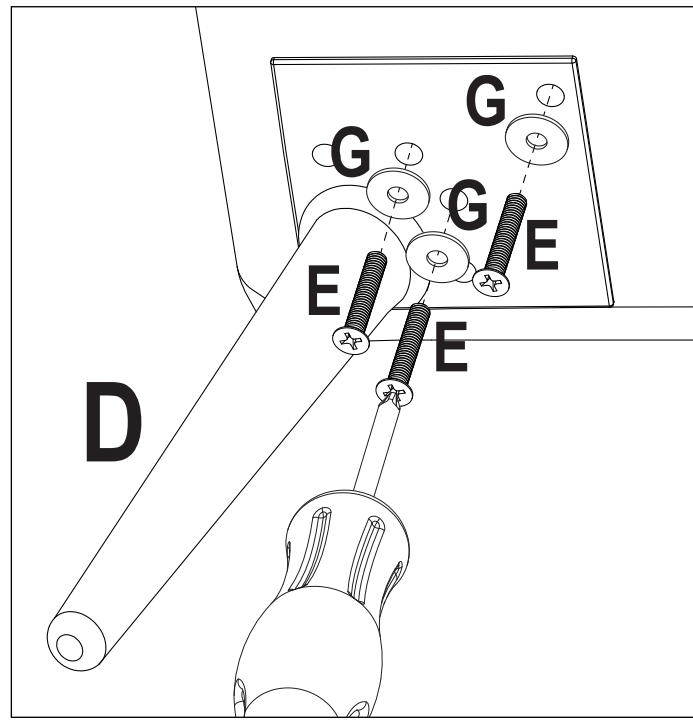
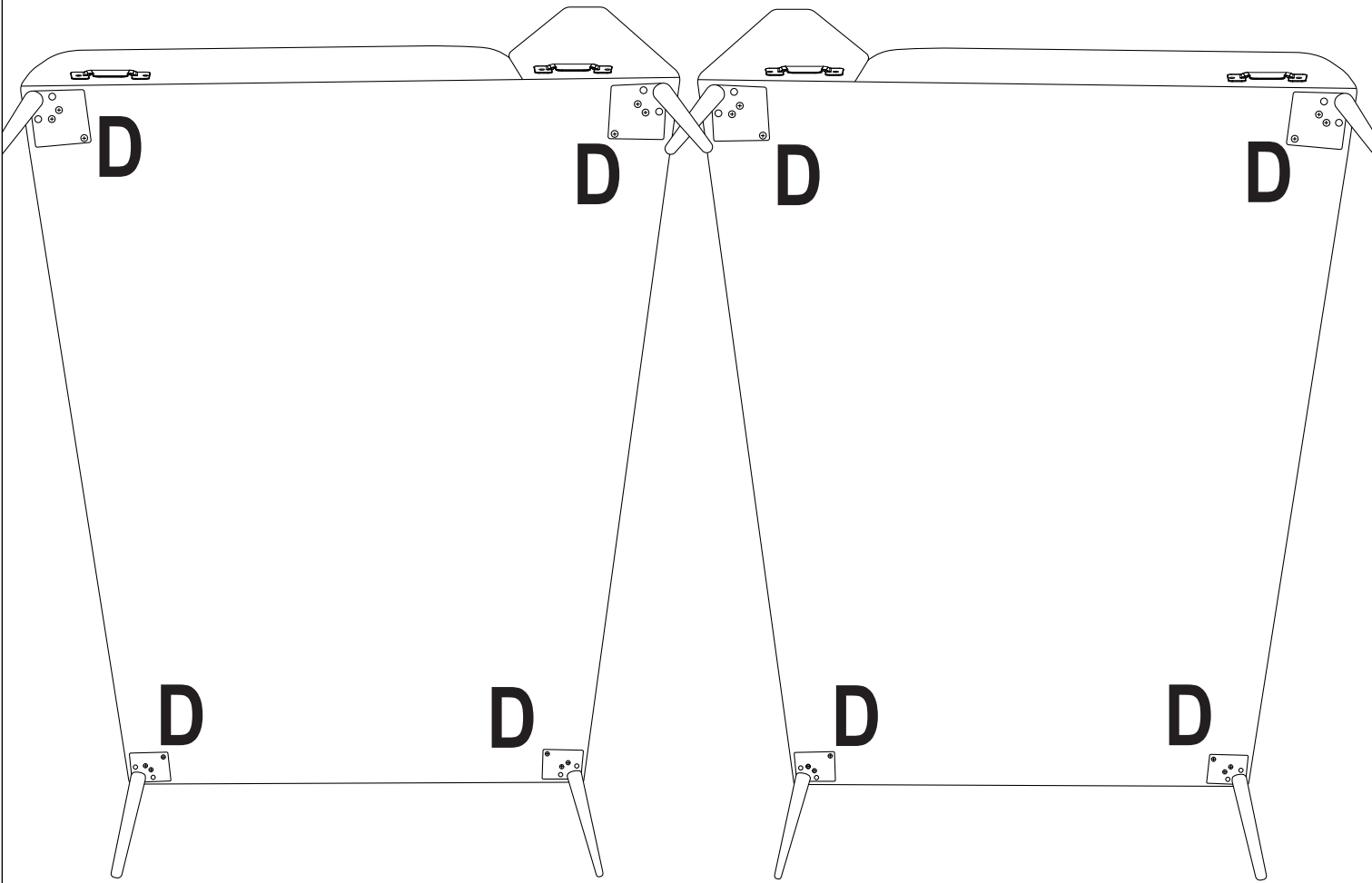
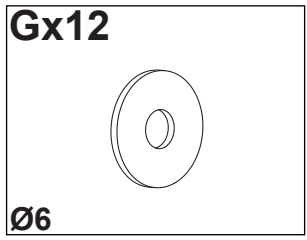
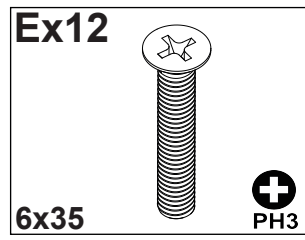
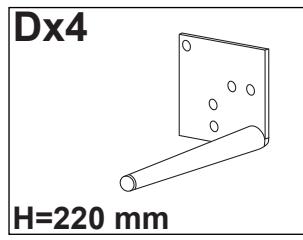

2

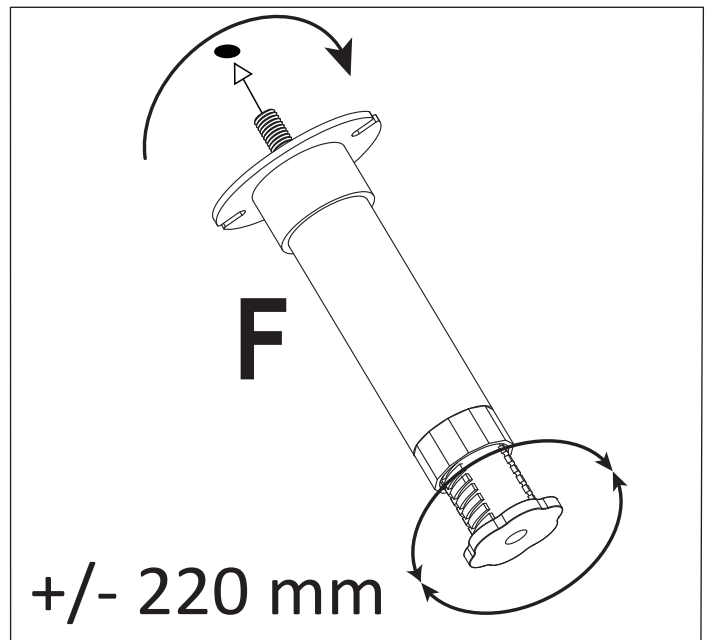
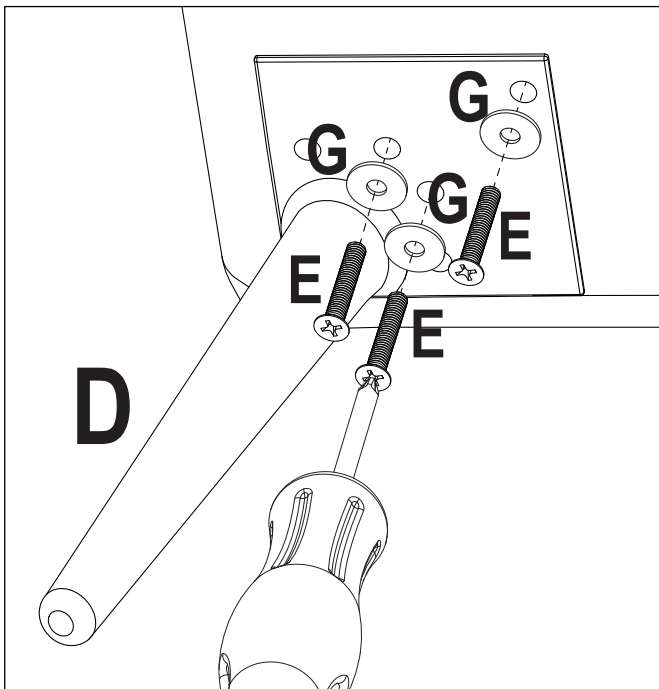
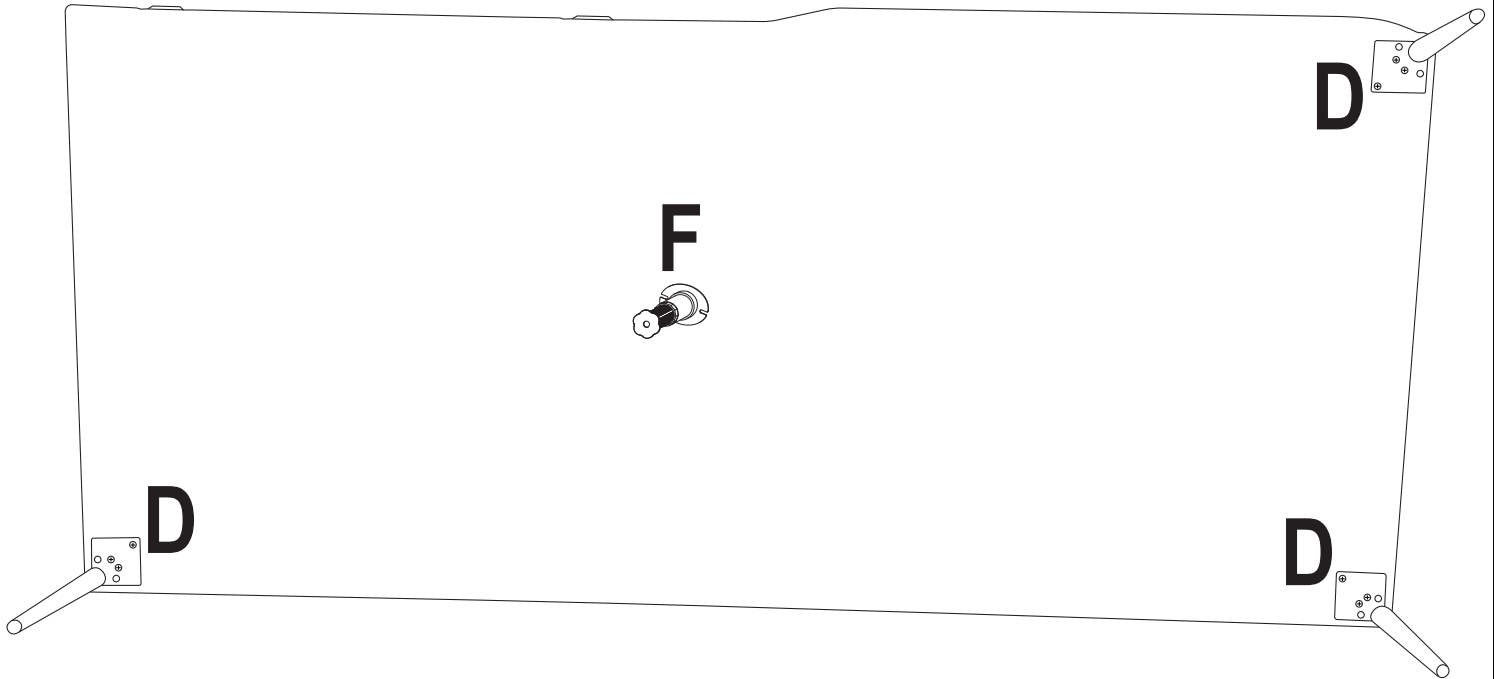
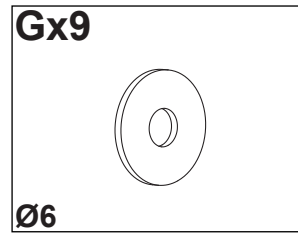
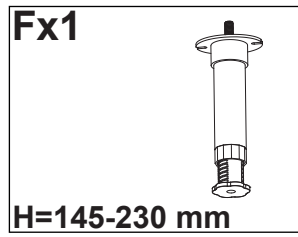
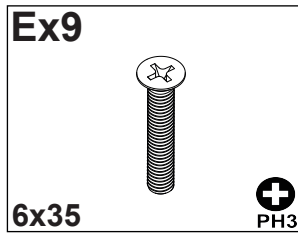
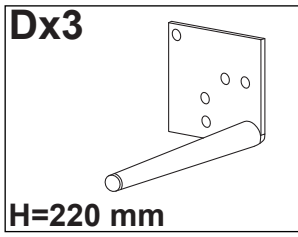

3

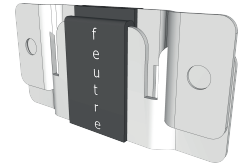
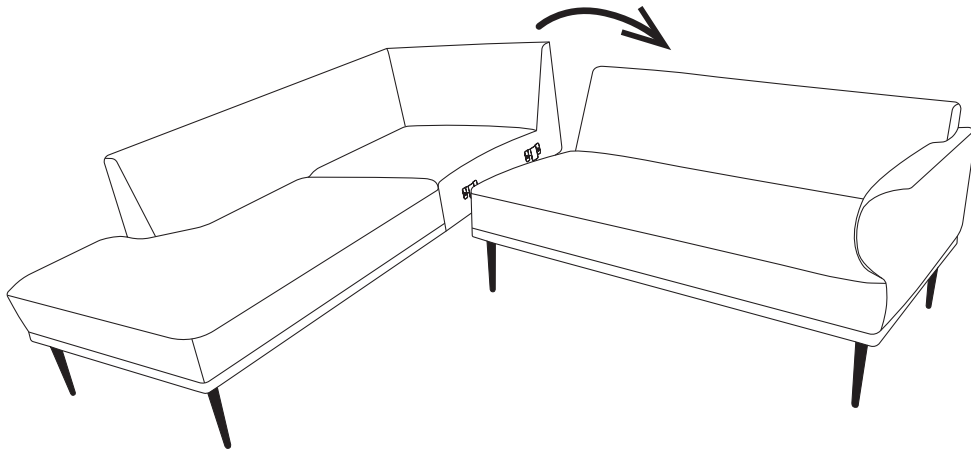
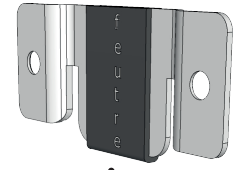
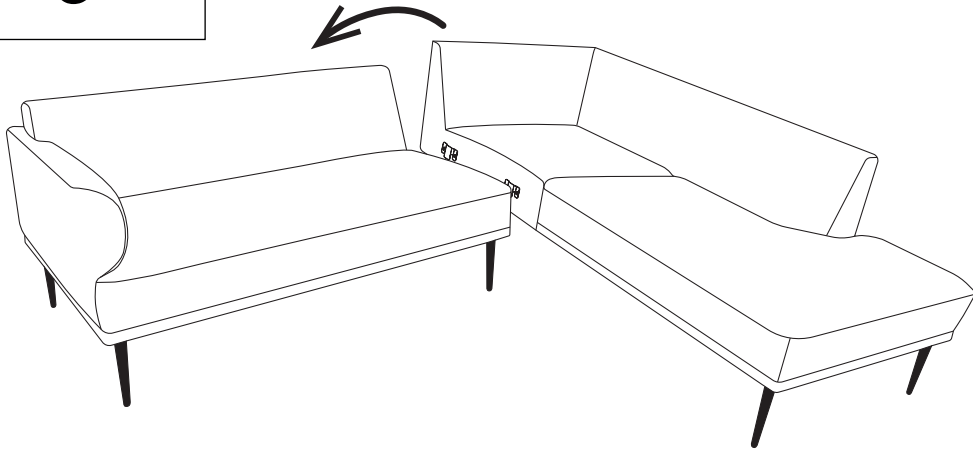

4

