

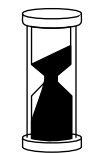

NORIDA

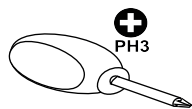

30min

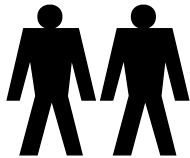

R

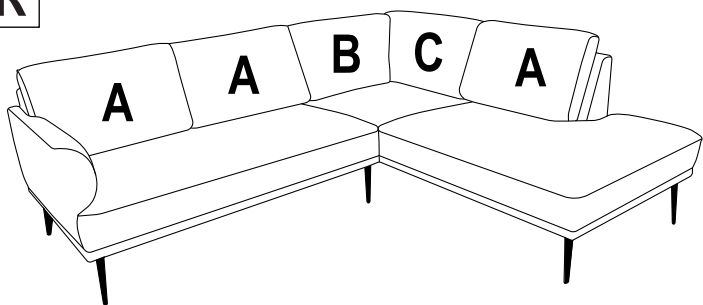

L

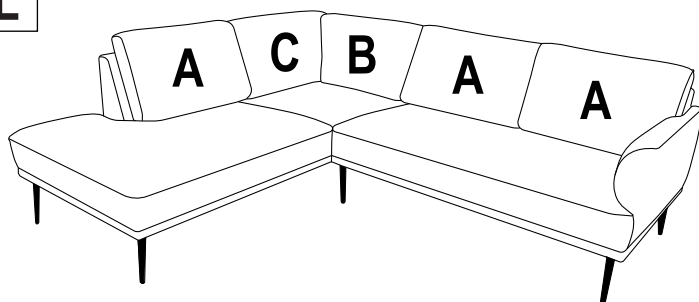

I

R | L

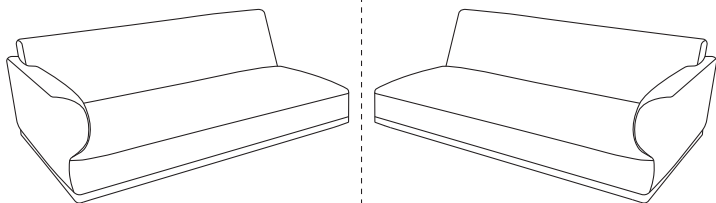

II

R | L

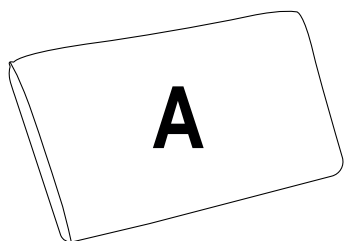
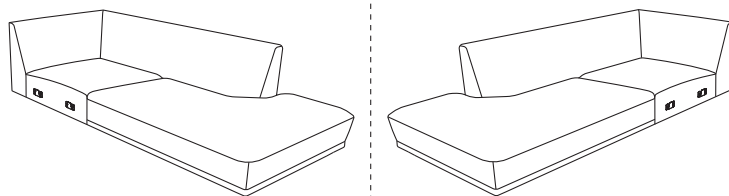

A

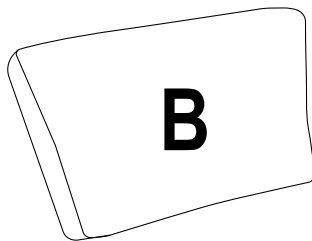

B

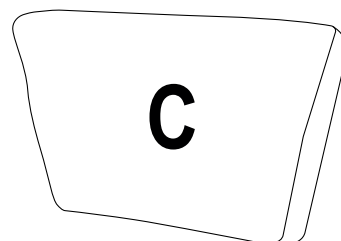

C

Dx7

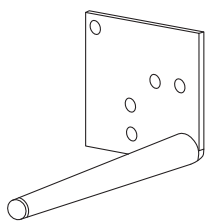

H=220 mm

Ex21

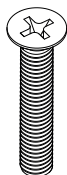

6x35



PH3

Fx1

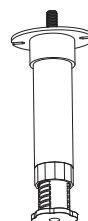

H=145-230 mm

Gx21

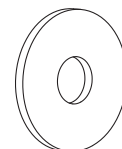

Ø6

1

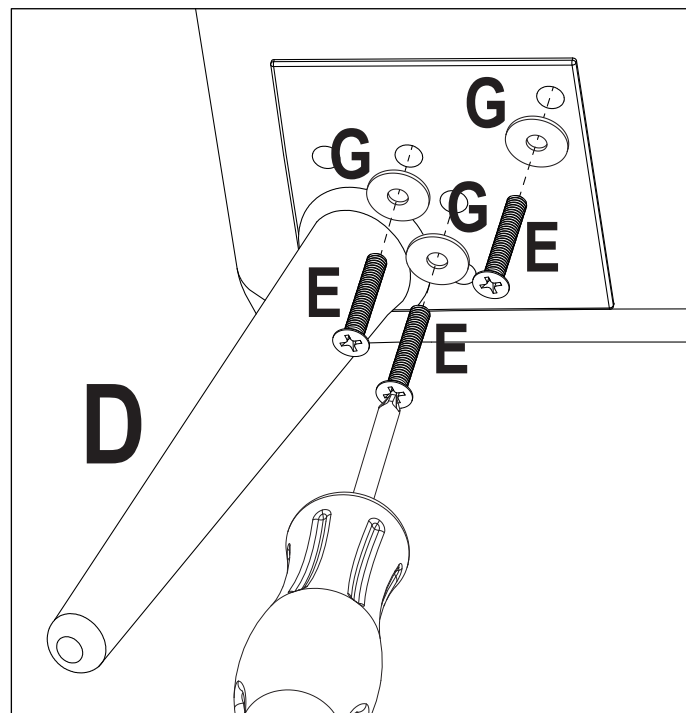
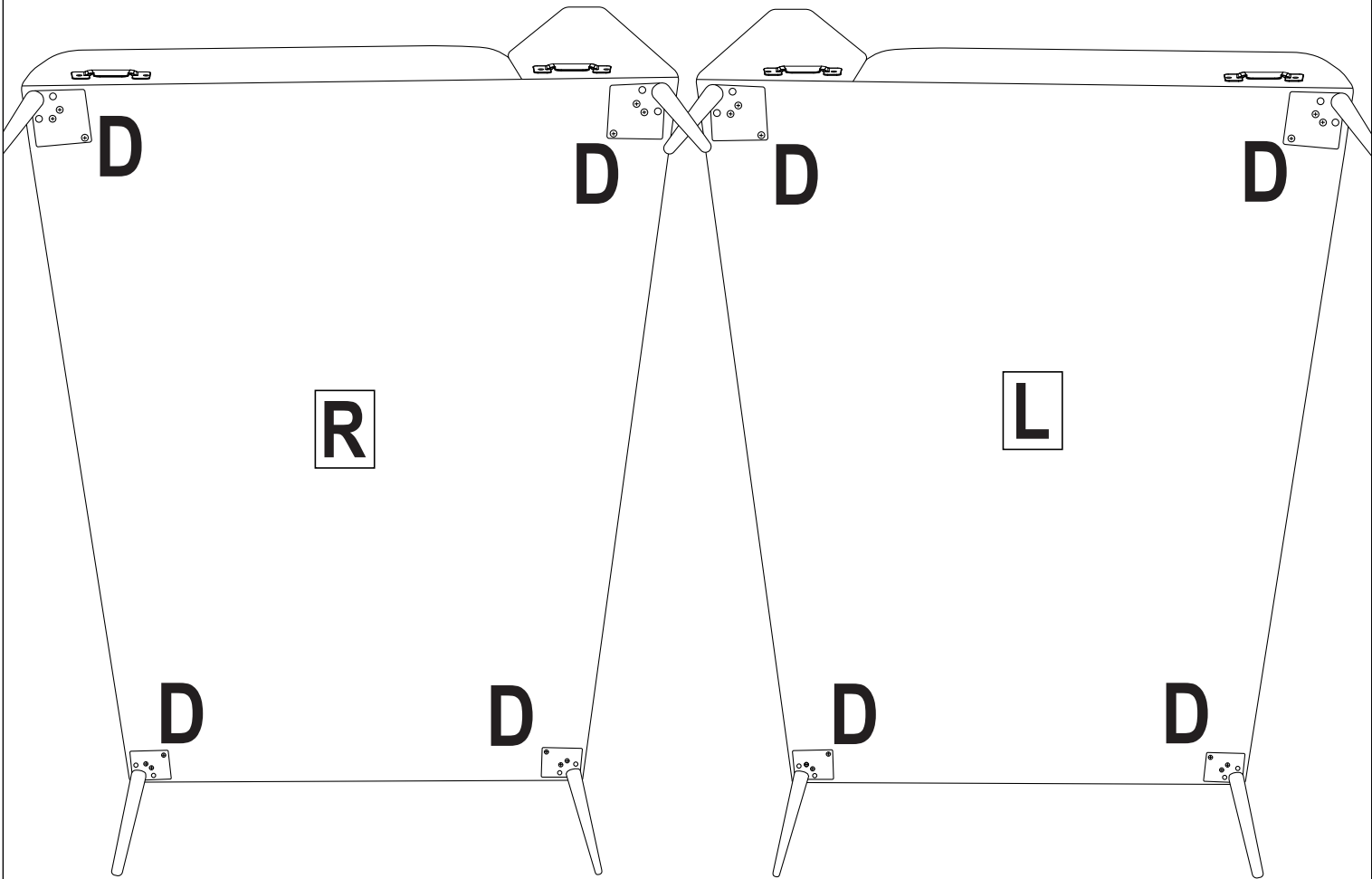
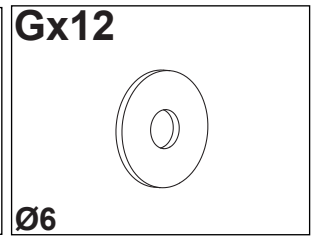
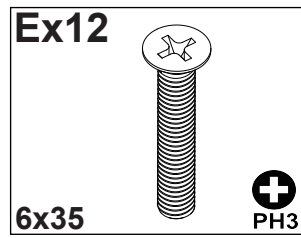
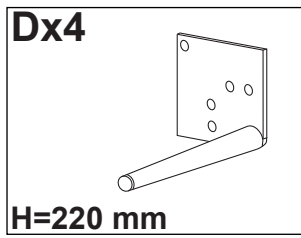

2

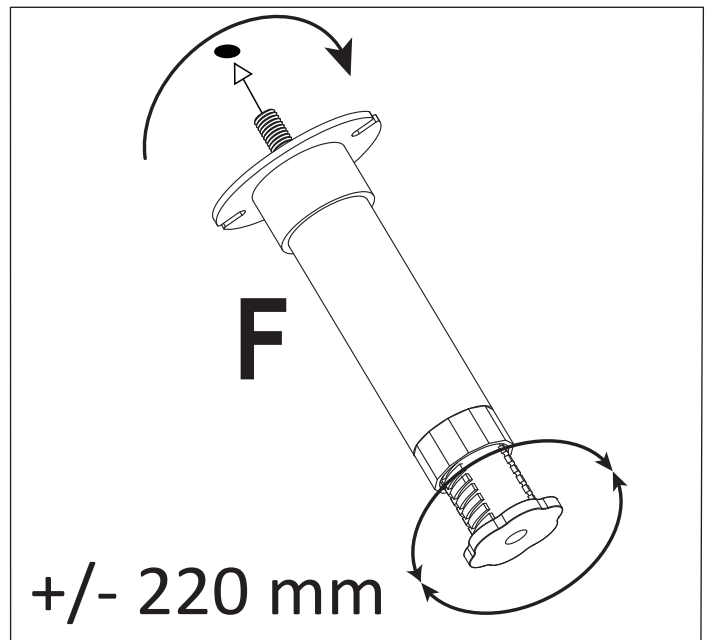
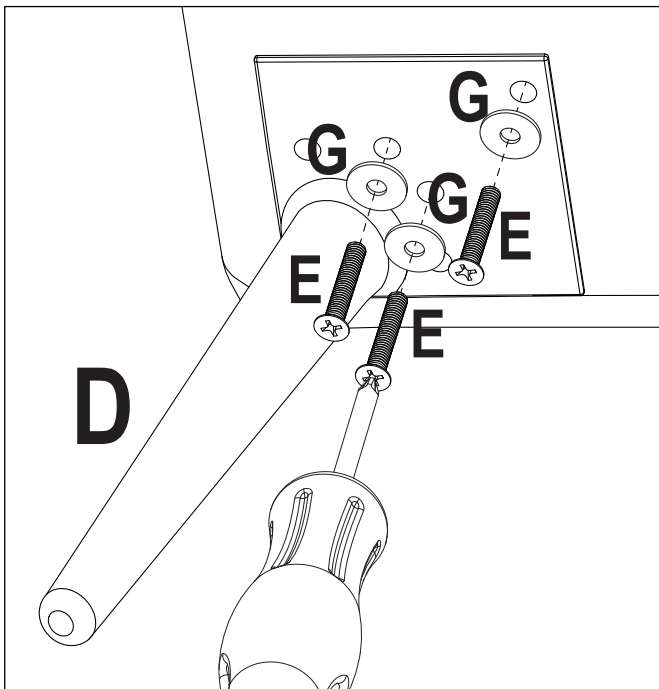
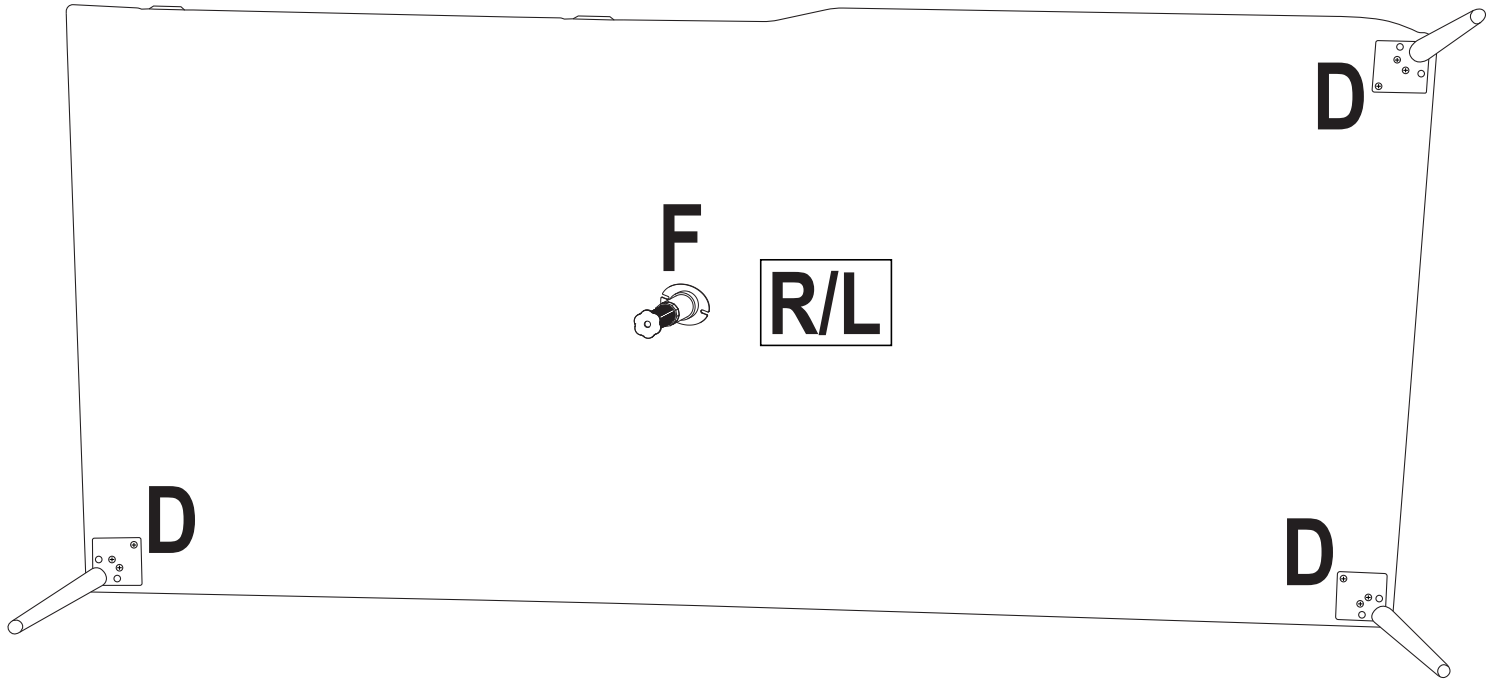
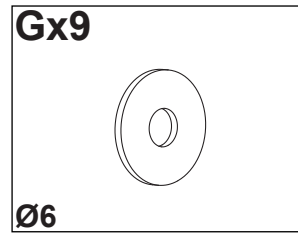
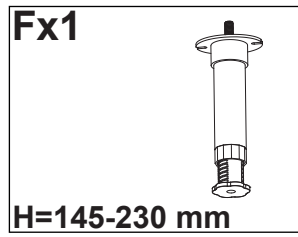
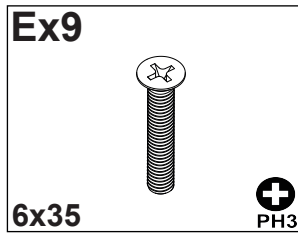
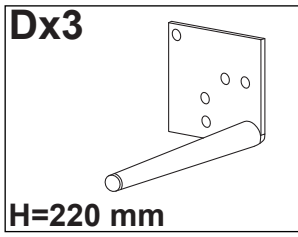

3

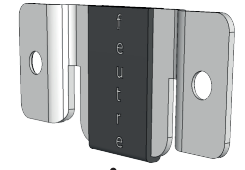
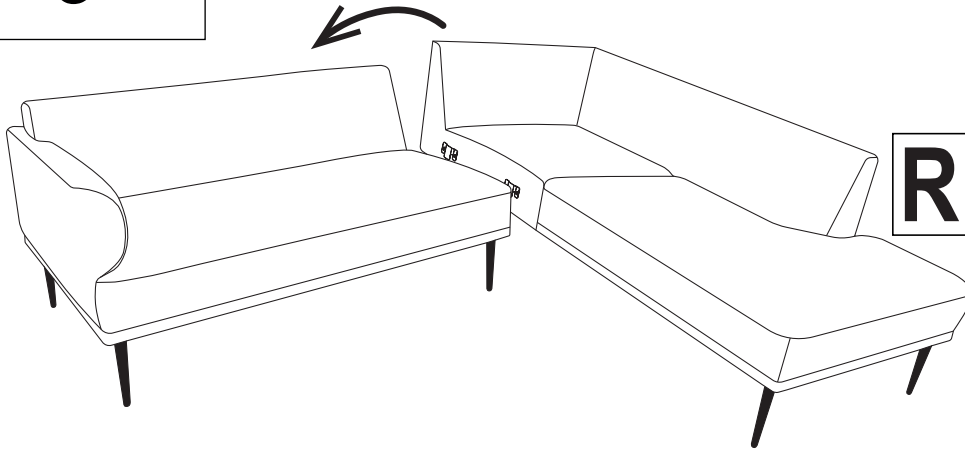

L

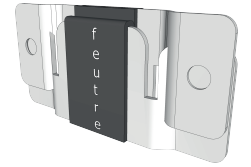
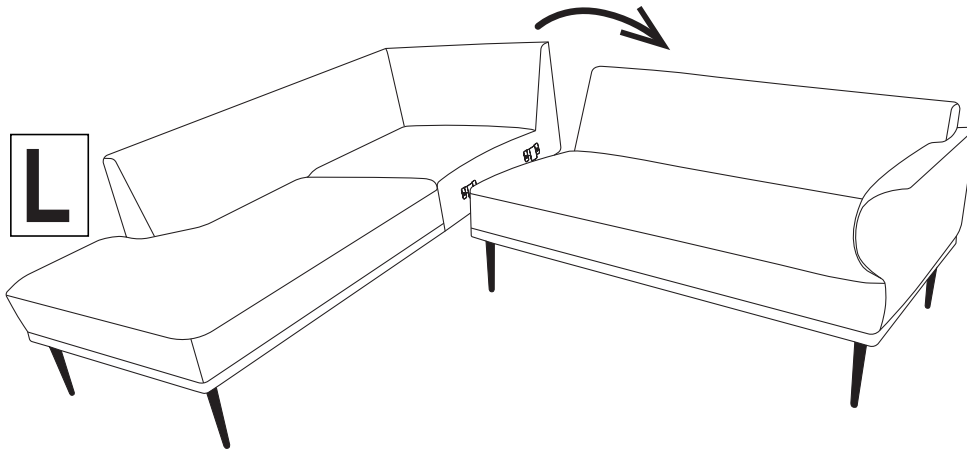

4

