









 <p>ENOMALIS DC267</p>	<p>A</p>  <p>M6*40 2x</p>	<p>B</p>  <p>M6*20 12x</p>	<p>C</p>  <p>14x</p>	
	<p>D</p>  <p>1x</p>			
	 <p>①x1</p>	 <p>②x1</p>	 <p>③x1</p>	
 	 <p>④x1</p>			

Step 1



Step 2

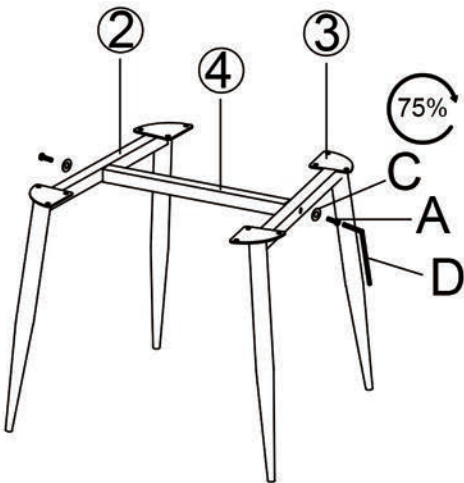