

ROMEO

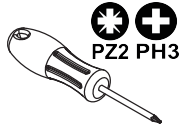

30min

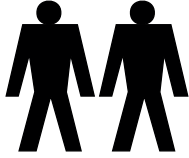

PZ2 PH3

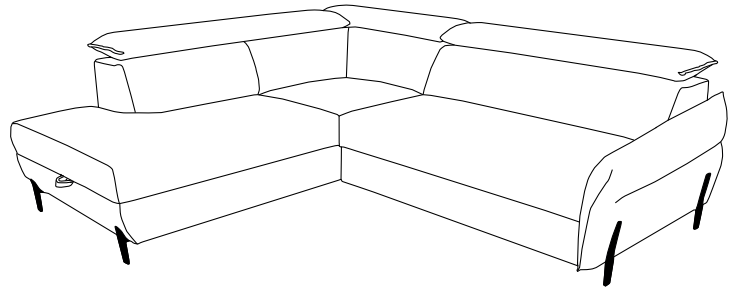
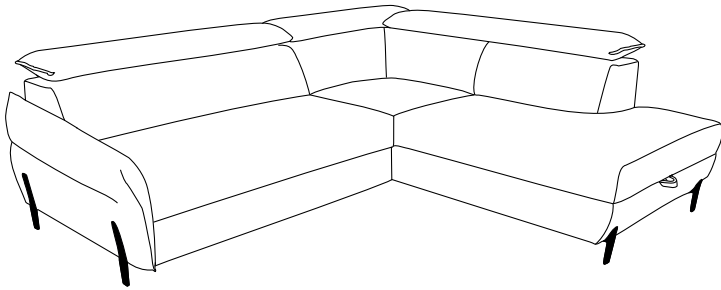

I

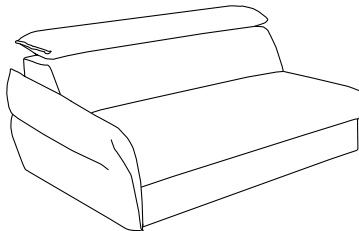

II

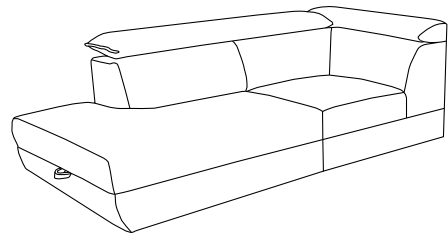
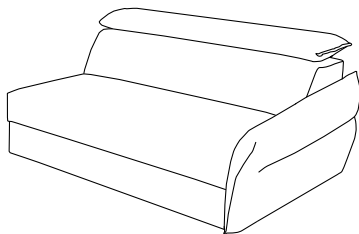
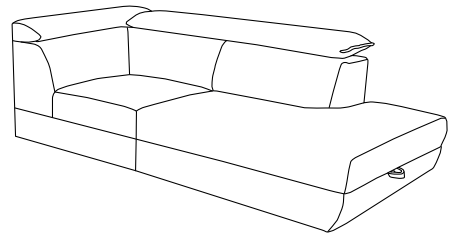

Ax2

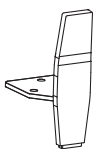

H=100/160 mm

Bx2



H=100/260 mm

Cx2

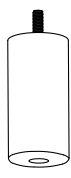

H=100 mm

Dx6

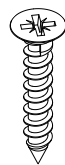

5x25

PZ2

Ex6

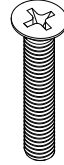

6x35

PH3

Fx1



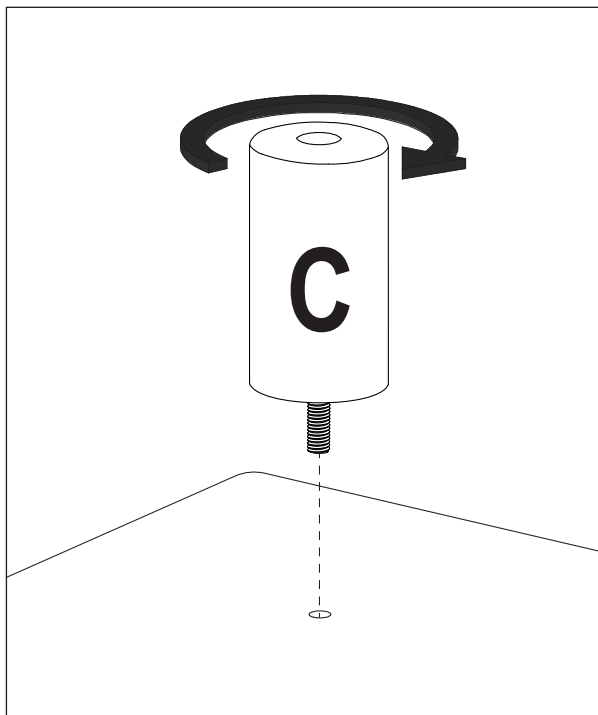
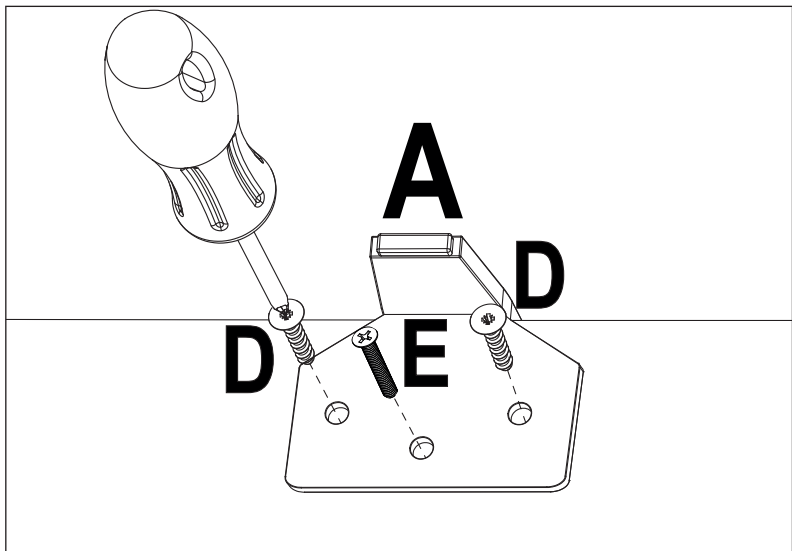
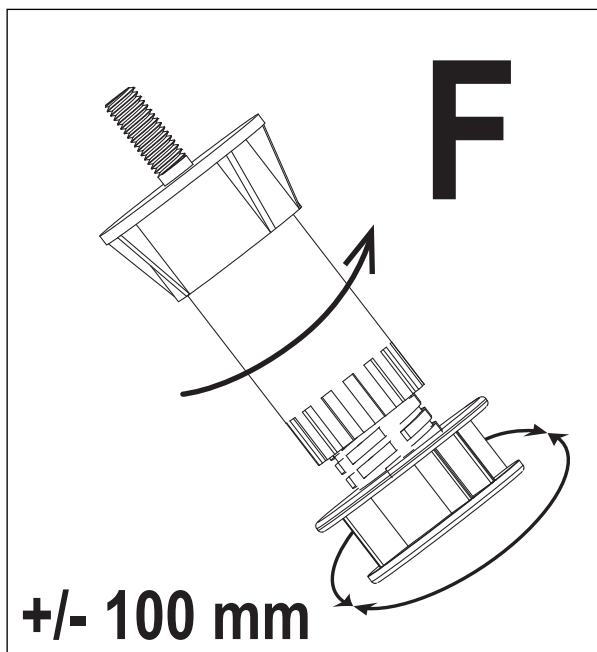
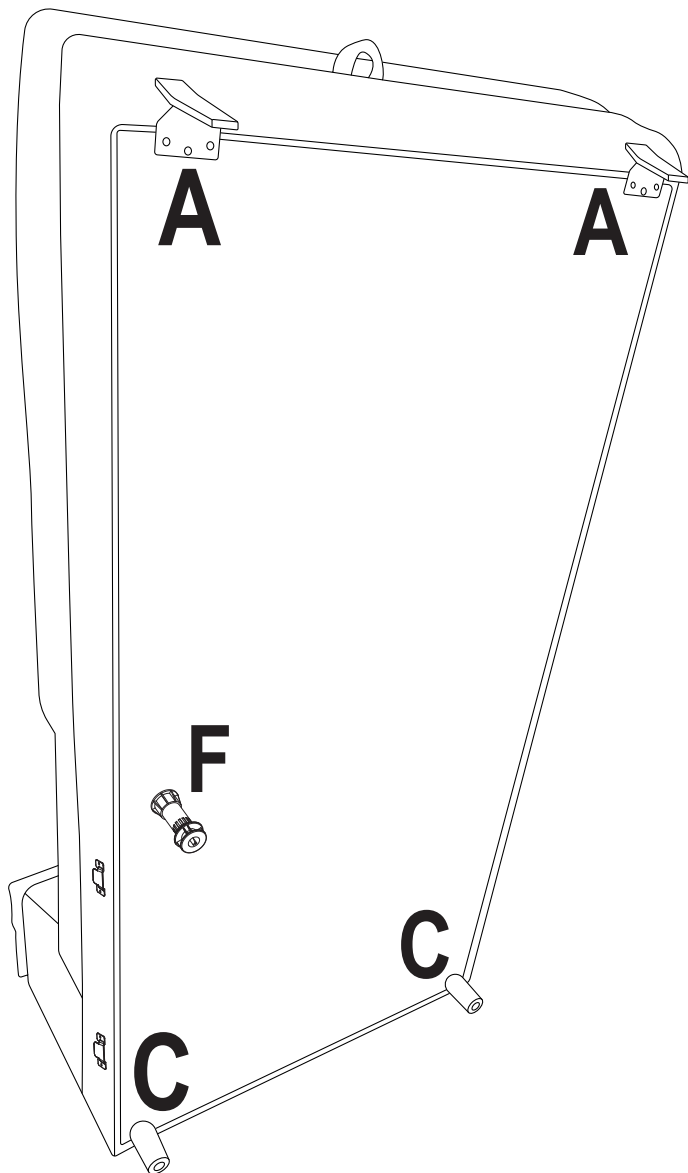
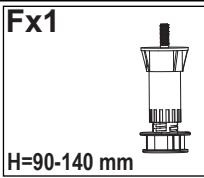
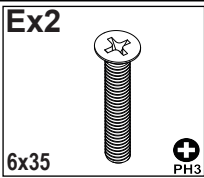
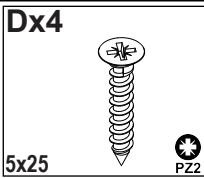
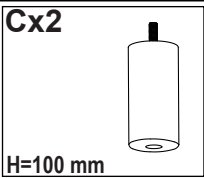
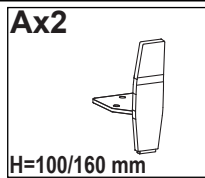

H=90-140 mm

1

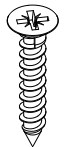
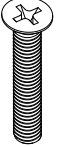

2

Bx2 H=100/260 mm 	Dx2 5x25 	Ex4 6x35 
		

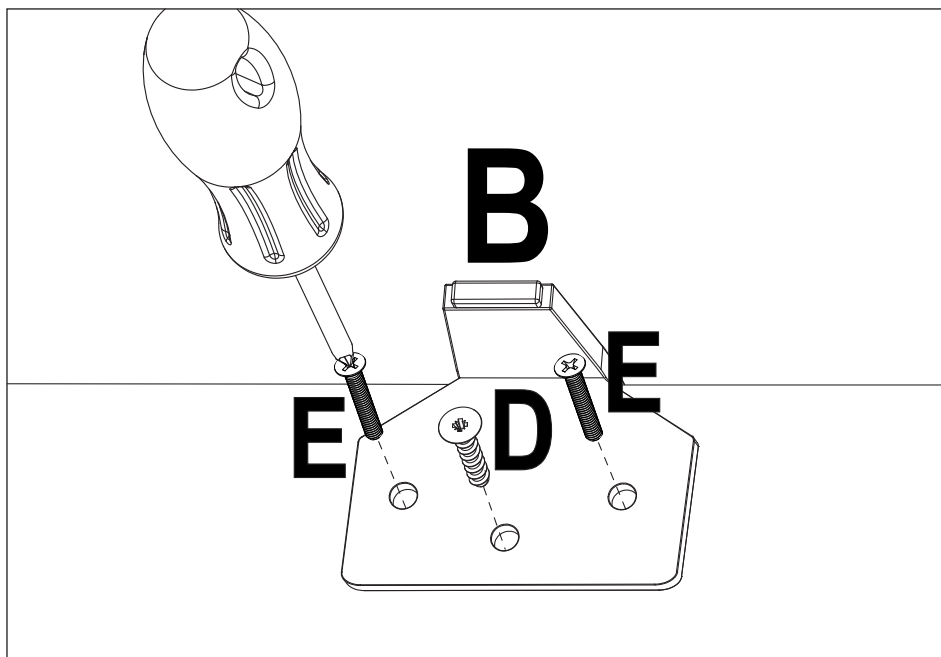
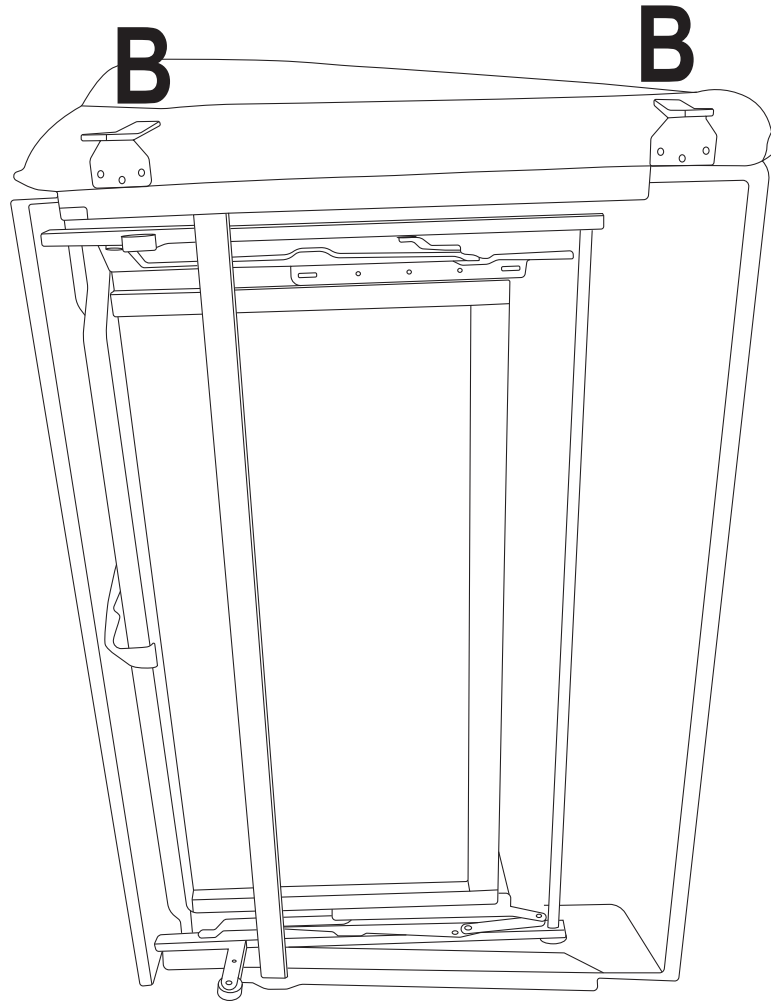

3

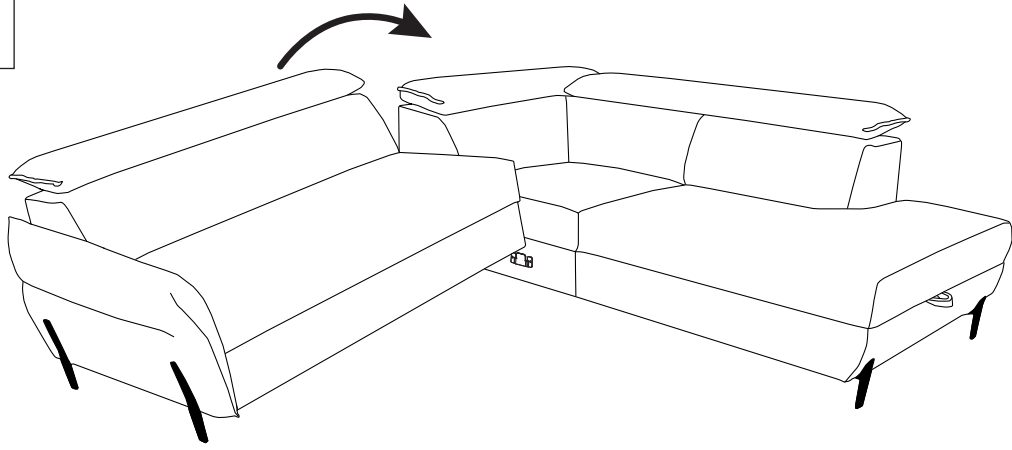

4

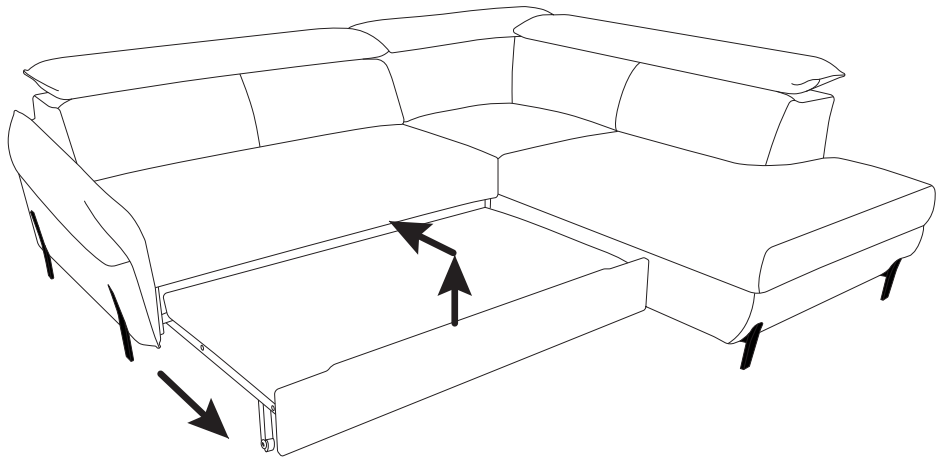

5

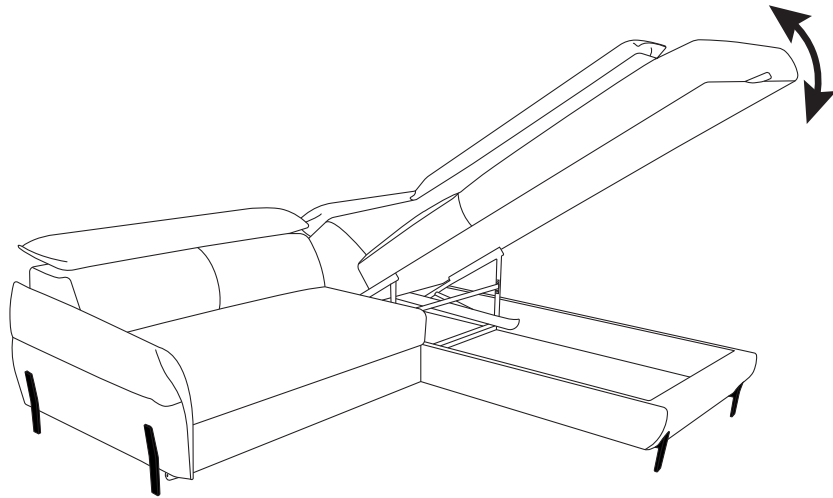

6

