

# ROMEO

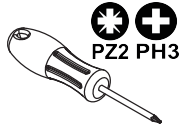

30min

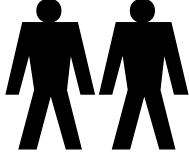

PZ2 PH3

R

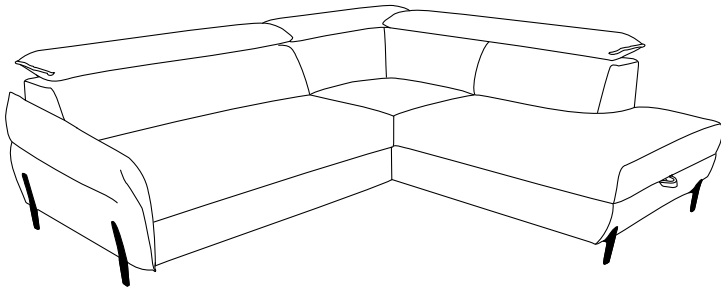

L

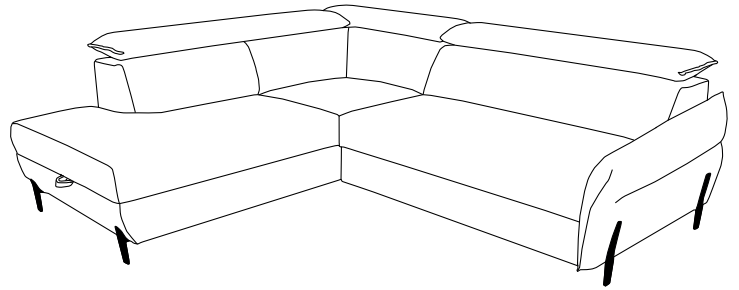

I

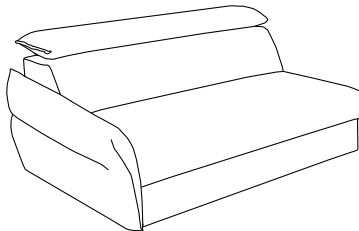

II

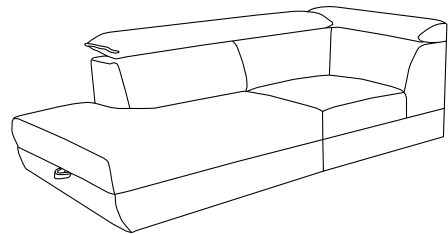
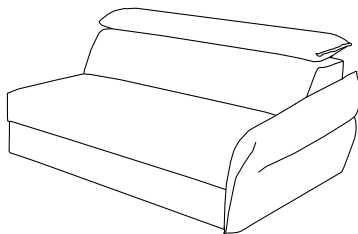
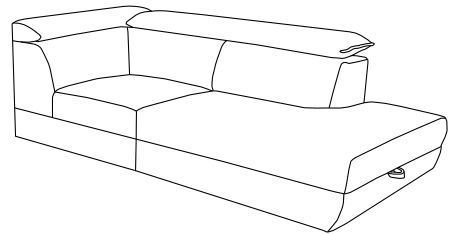

Ax2

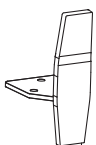

H=100/160 mm

Bx2



H=100/260 mm

Cx2



H=100 mm

Dx6

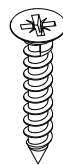

5x25



PZ2

Ex6

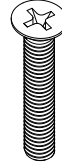

6x35



PH3

Fx1



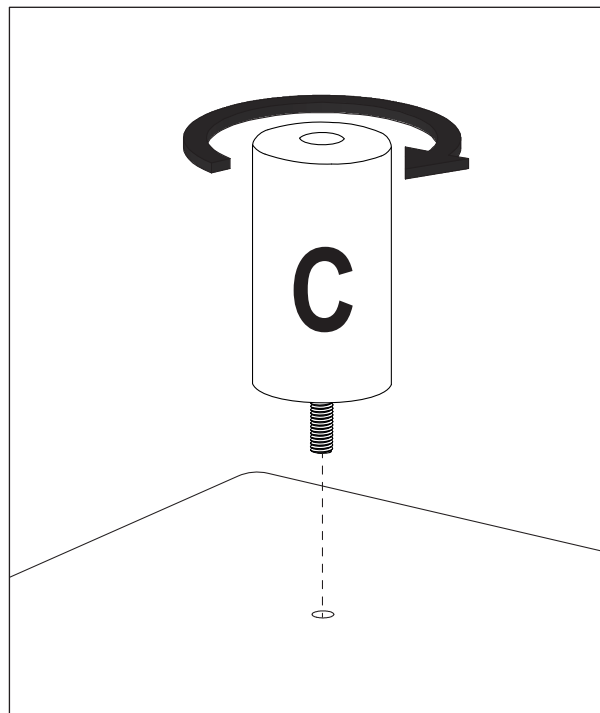
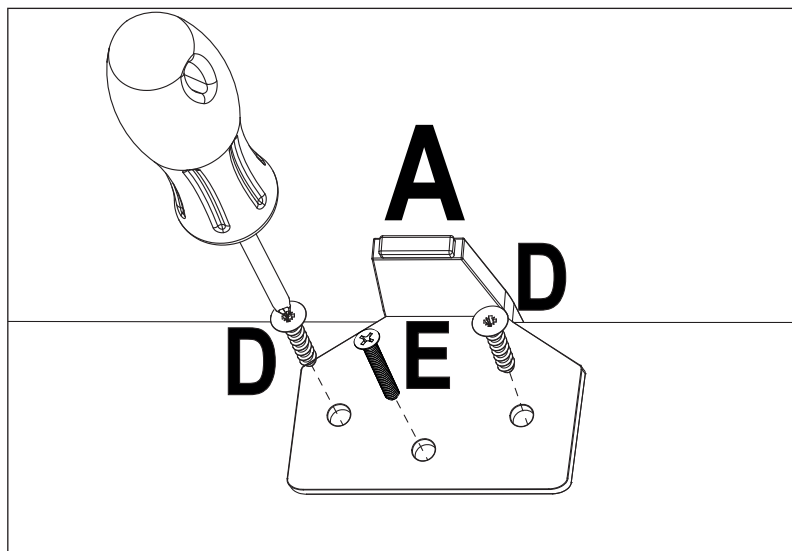
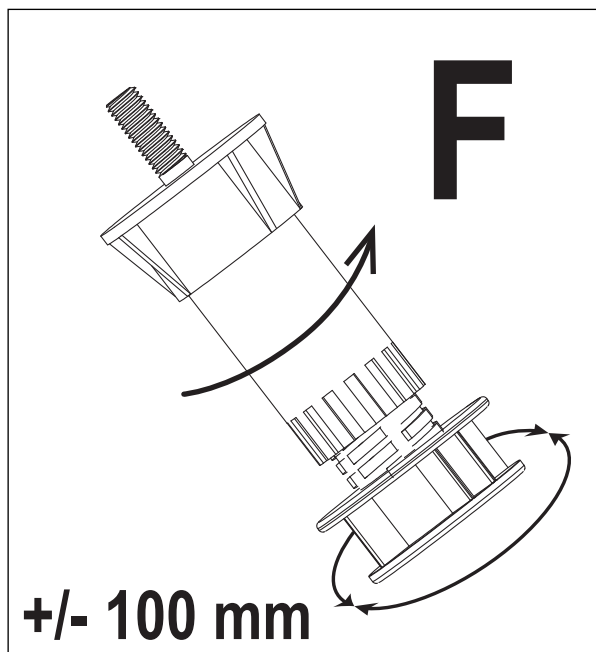
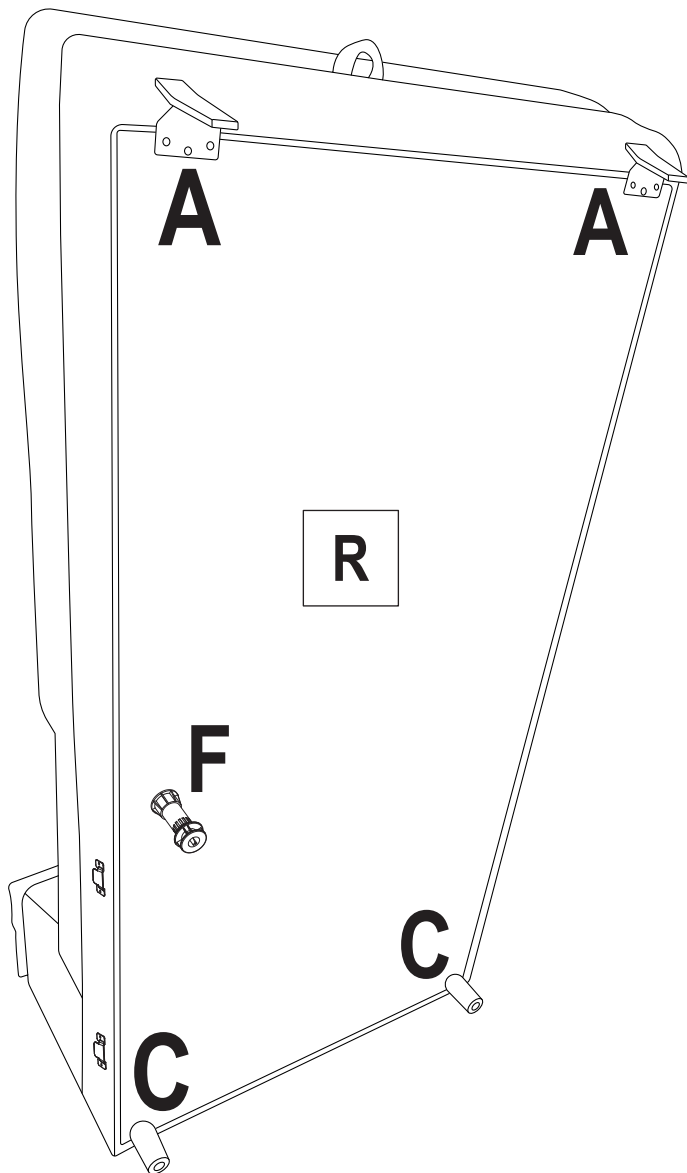
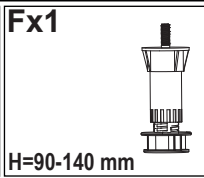
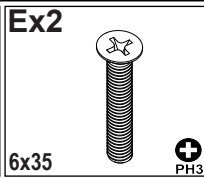
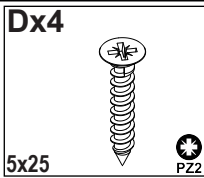
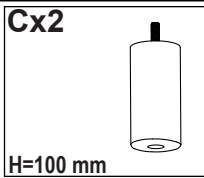
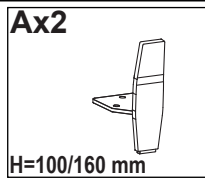

H=90-140 mm

1

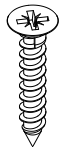
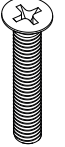

2

<b>Bx2</b> H=100/260 mm 	<b>Dx2</b> 5x25 	<b>Ex4</b> 6x35 
		

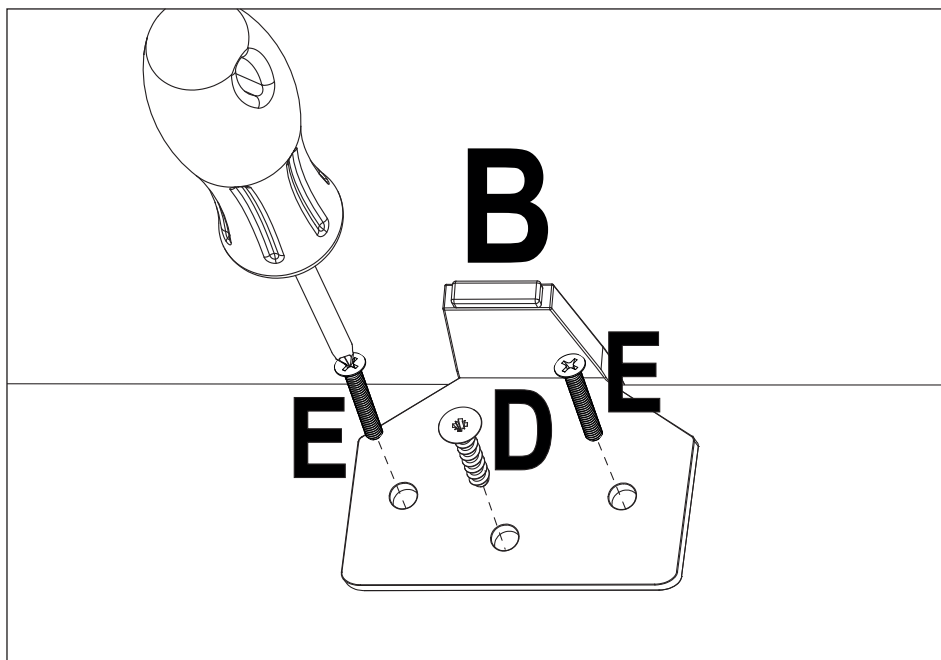
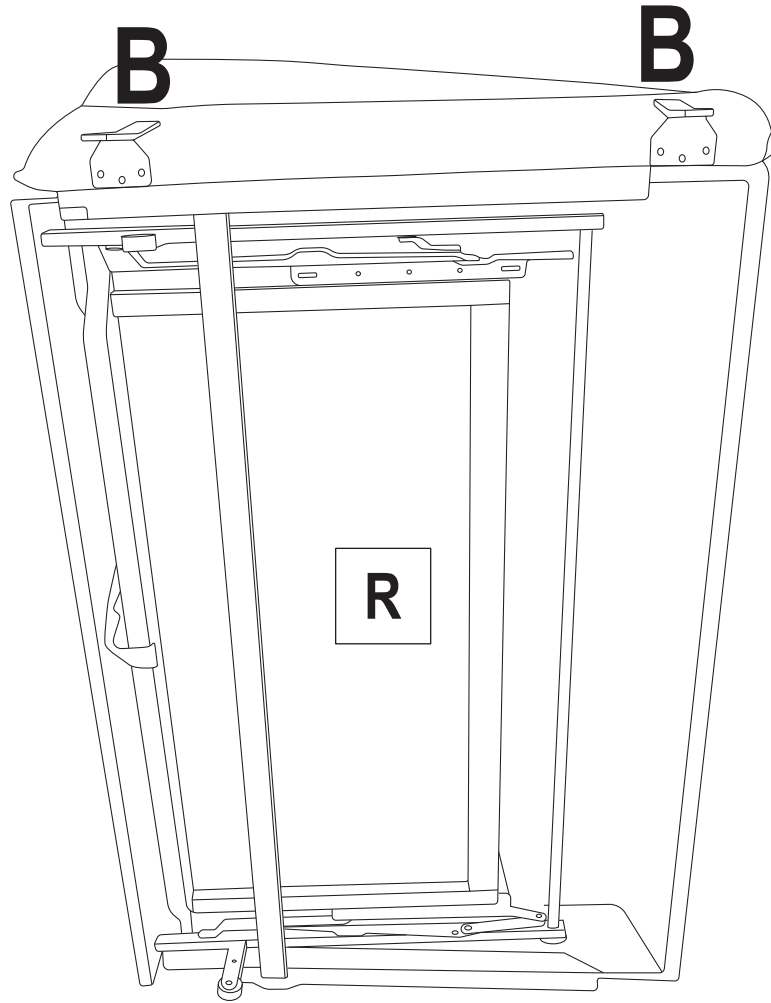

3

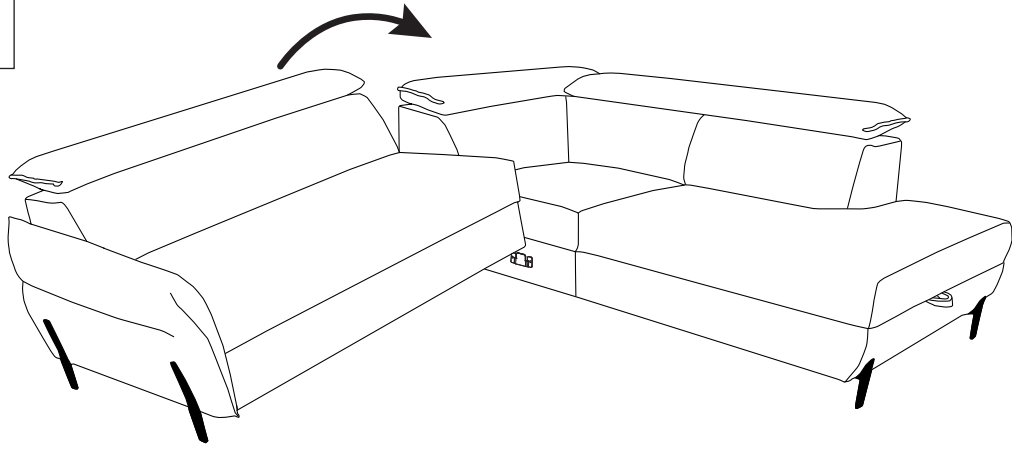

4

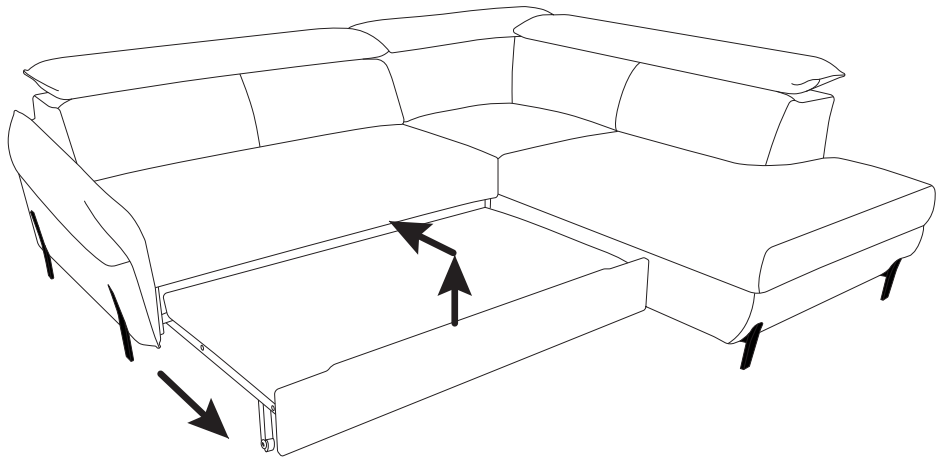

5

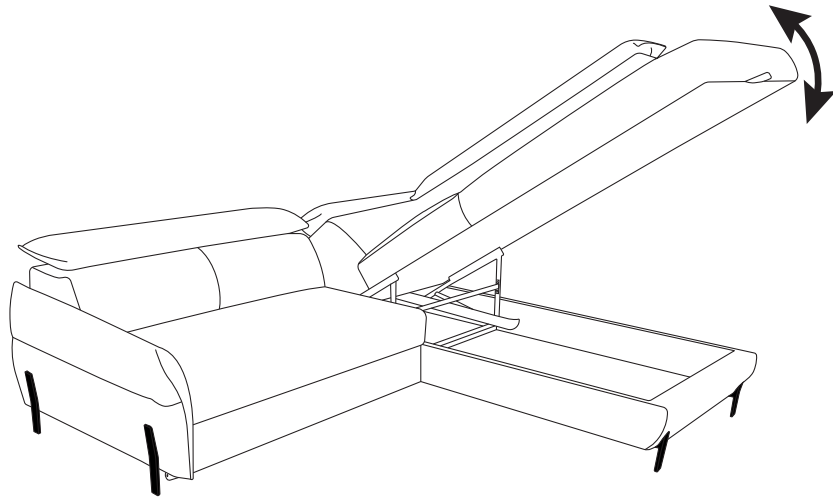

6

