

MALTA MA 11

PRODUCENT/PRODUCER/Výrobce/Výrobca:
 FABRYKA MEBLI "MEBLAR" SP. J
 63-604 Baranów ul. Budka 7 Polska
 biuro@meblar.com.pl
 tel. + 48 62 791 20 41

MADE IN POLAND

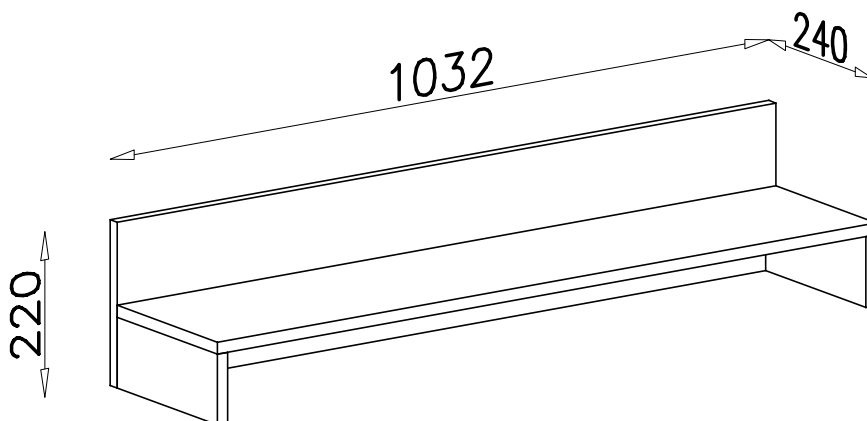
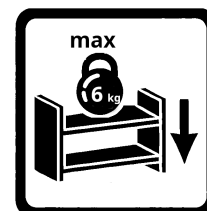
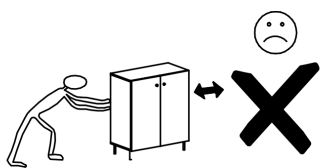
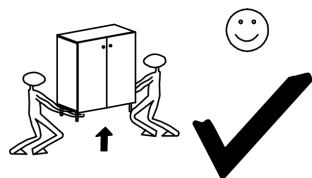
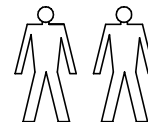
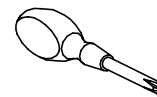
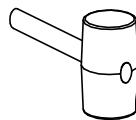
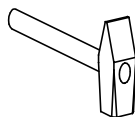
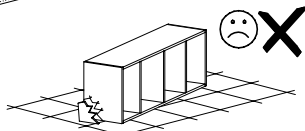
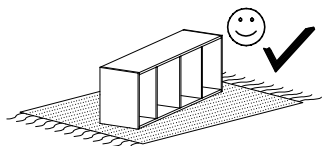

W1

x1



G4

4x16

x4

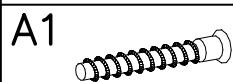

A1

ø7x50

x5

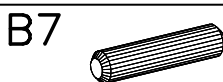

B7

ø8x30

x12

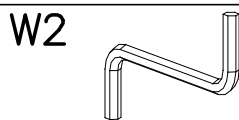

W2

x1

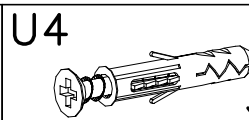

U4

x2

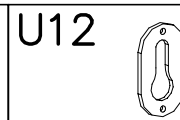

U12

x2

I

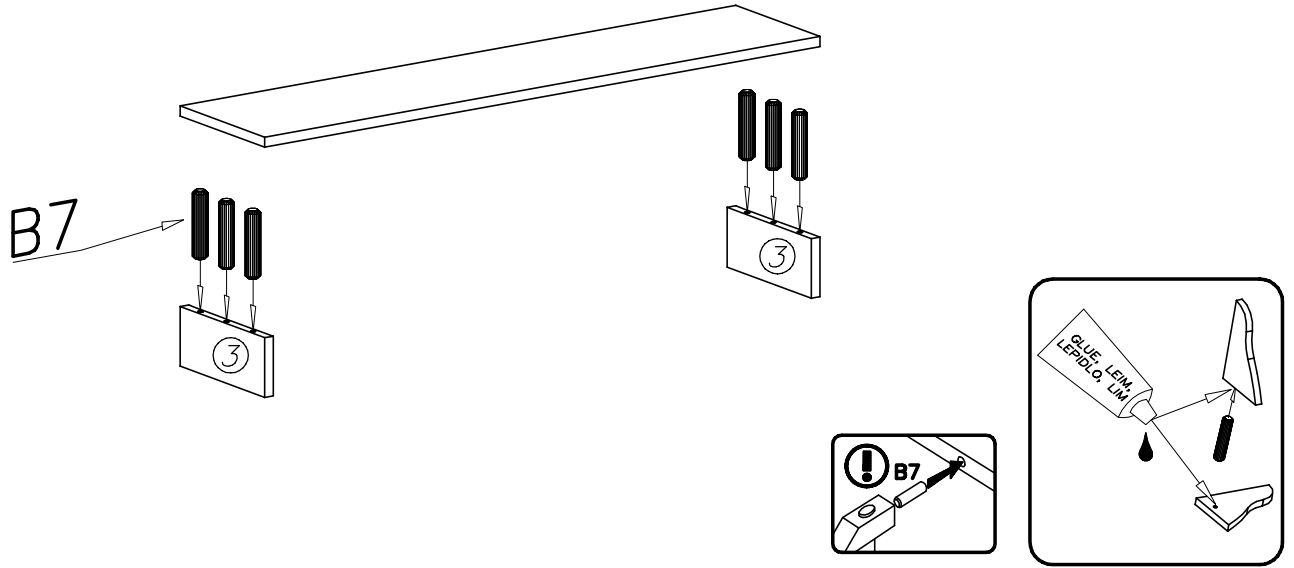

II

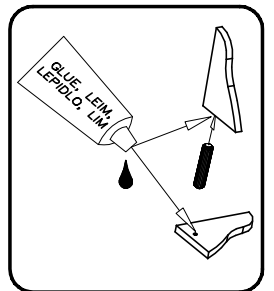
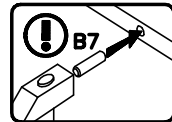
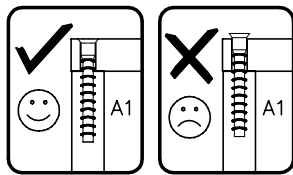
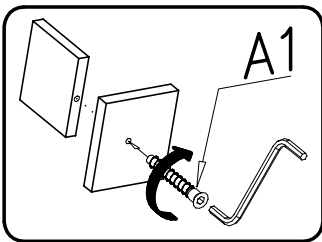
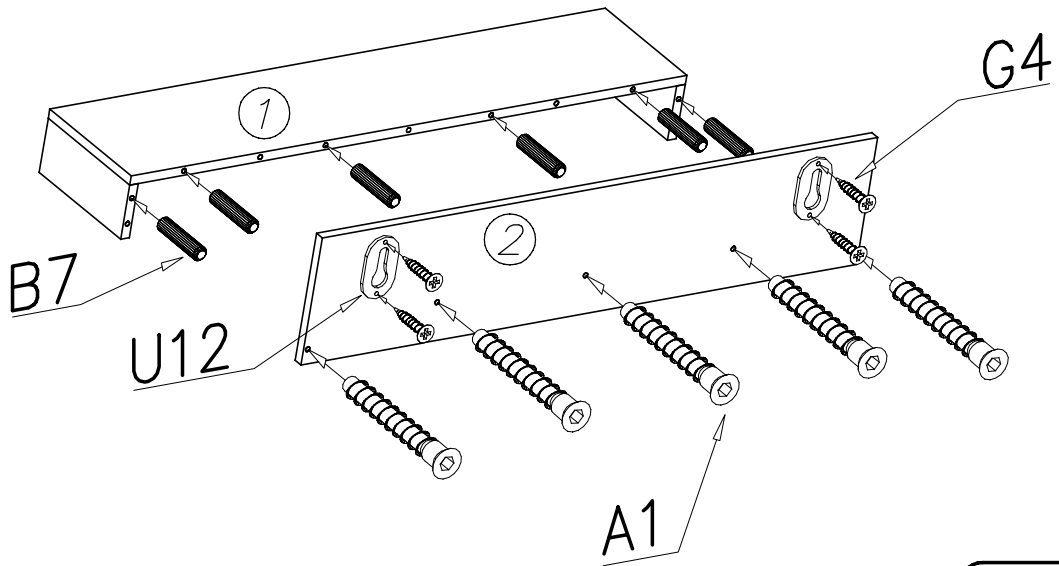

III

