

# CARLOS

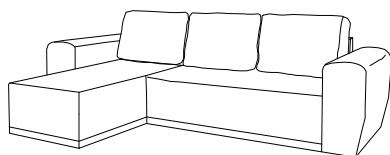

L

132 kg



R

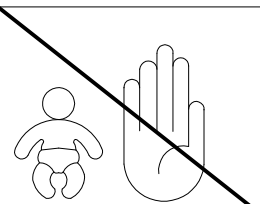
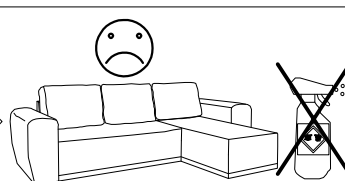
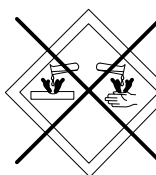
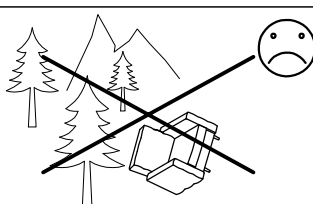
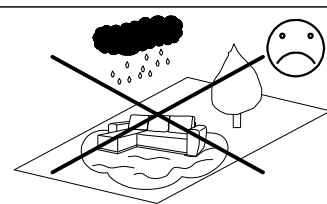
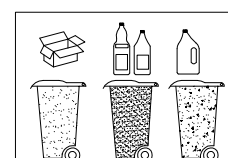
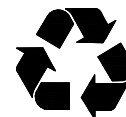
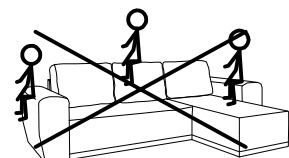
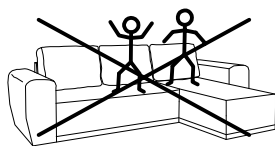
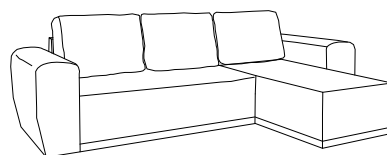

#	
1	1
2	1
3	1
4	1
5	1
6	3

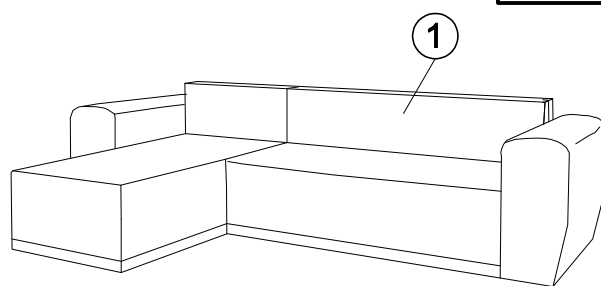
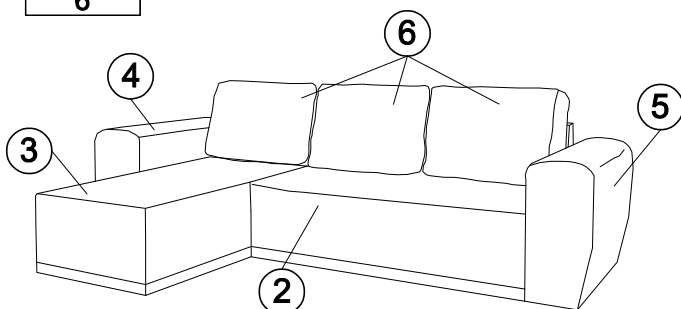
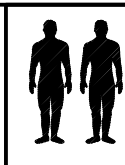
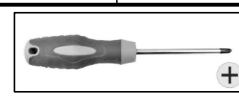
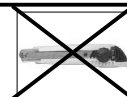
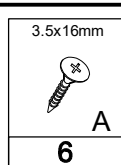

1

L

R

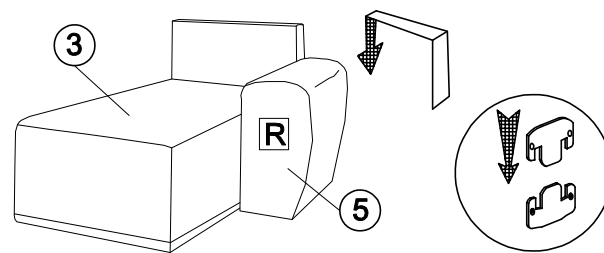
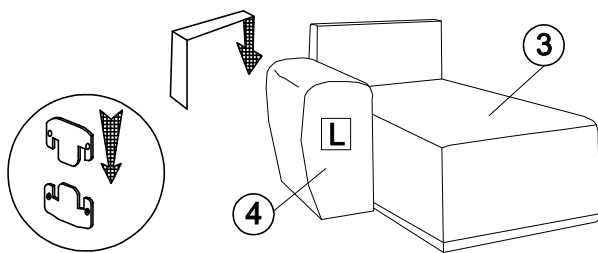

2

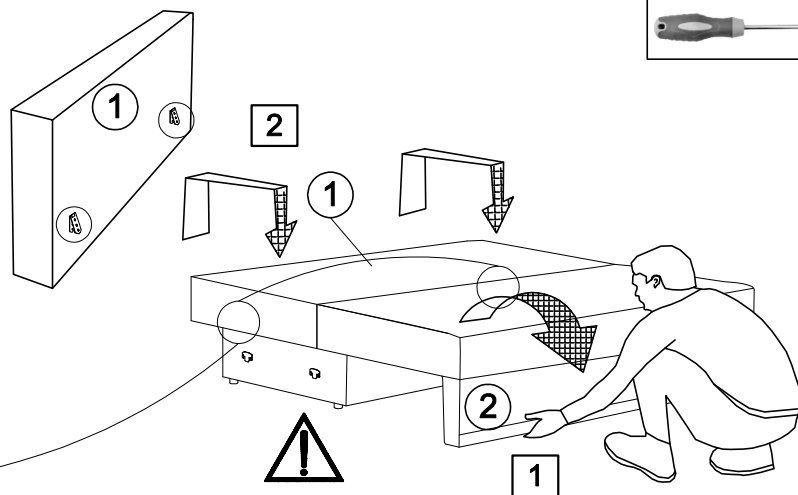
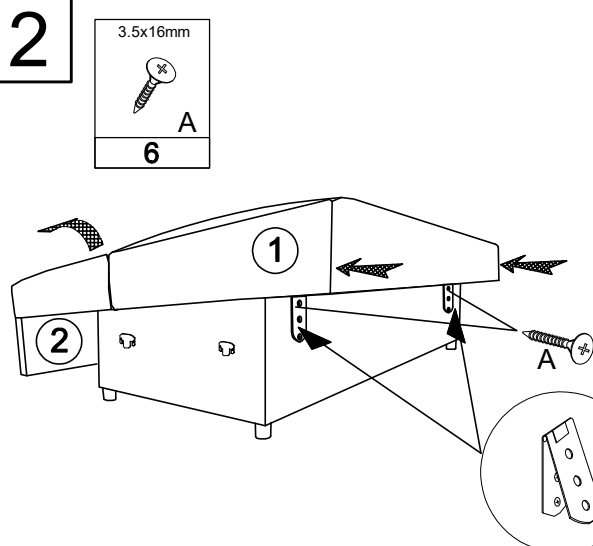
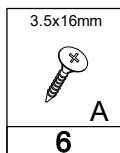

3

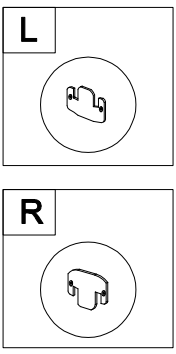
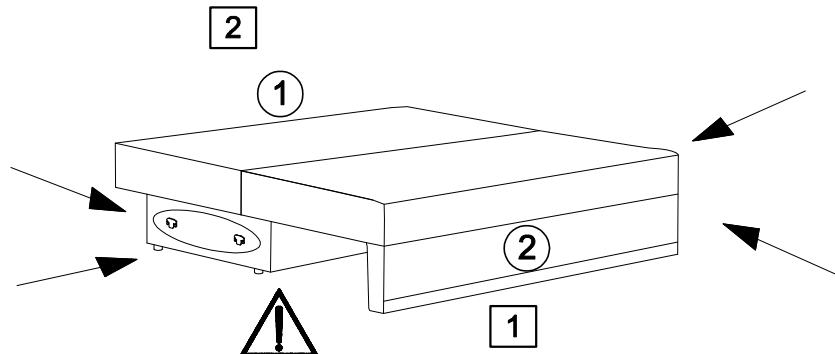
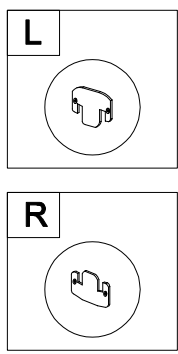
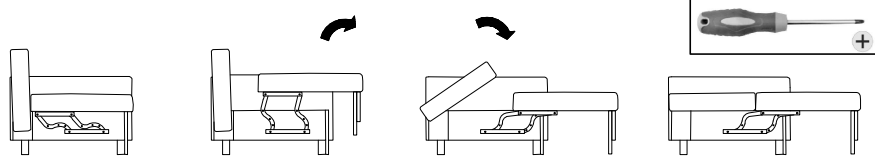
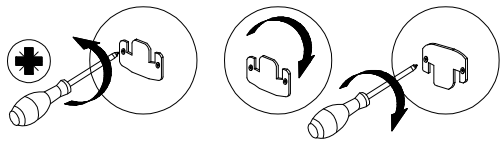

4

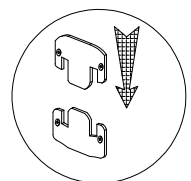

L

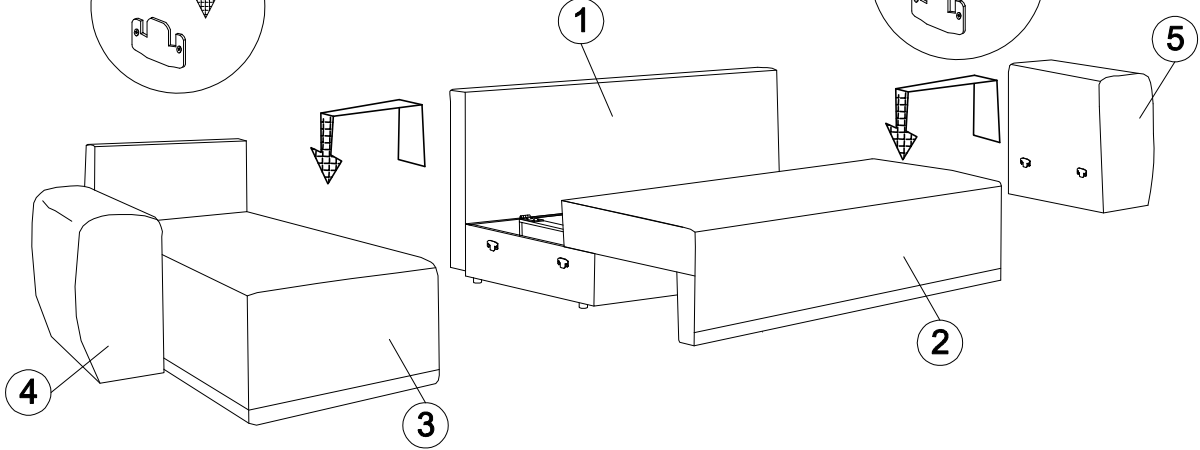
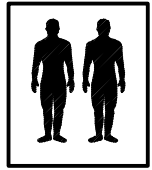
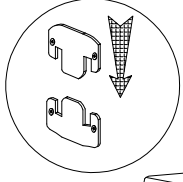

5

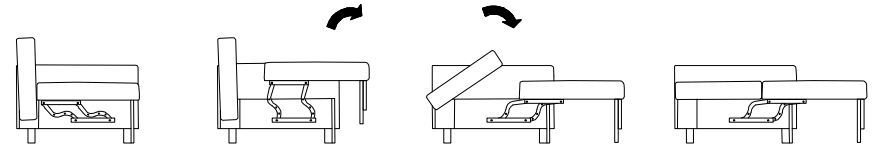
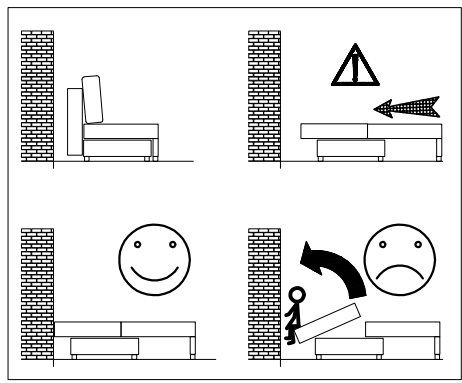
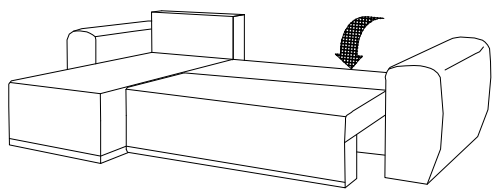
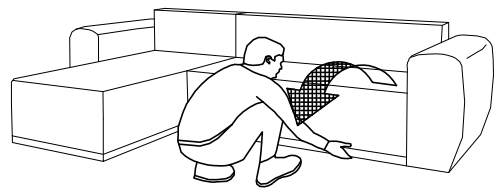

6

