

JENIRA(770325)

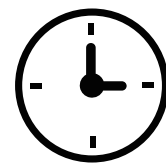

X1



10MIN

A

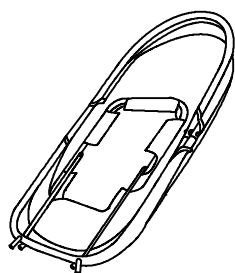

B



C



D



E



F

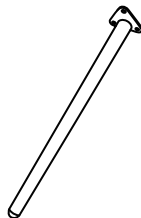

|   |     |
|---|-----|
| A | 2 x |
| B | 8 x |
| C | 2 x |
| D | 2 x |
| E | 1 x |
| F | 4 x |

1

M6x20mm



8x

2



12x

3

M6x10mm



12x

4



1

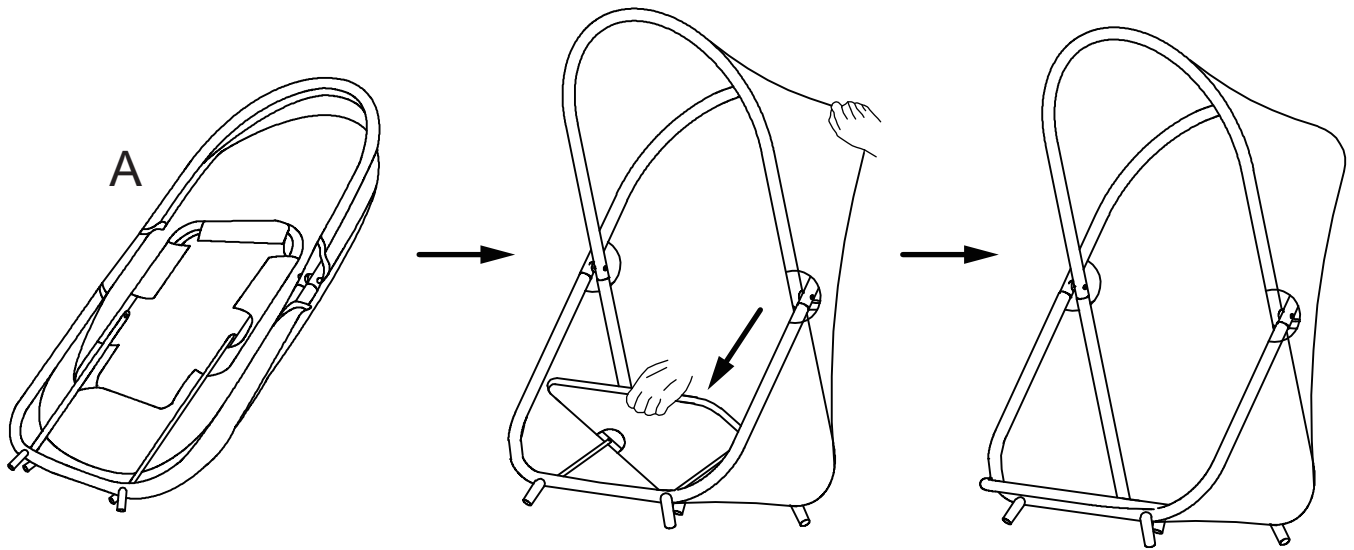

**x 2**

2

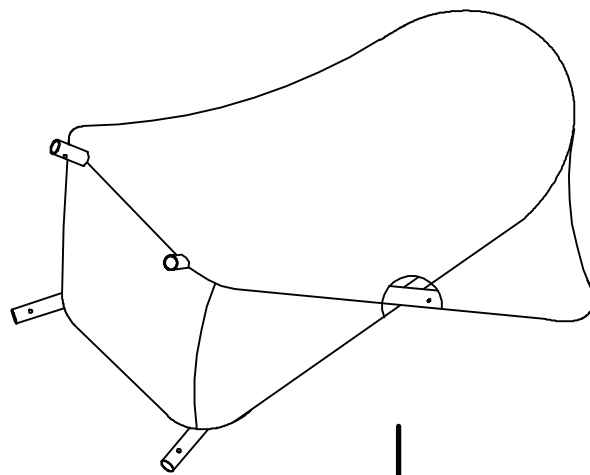

|   |         |    |
|---|---------|----|
| 1 | M6x20mm | 8x |
| 4 | Hex key | 1x |
|   |         |    |

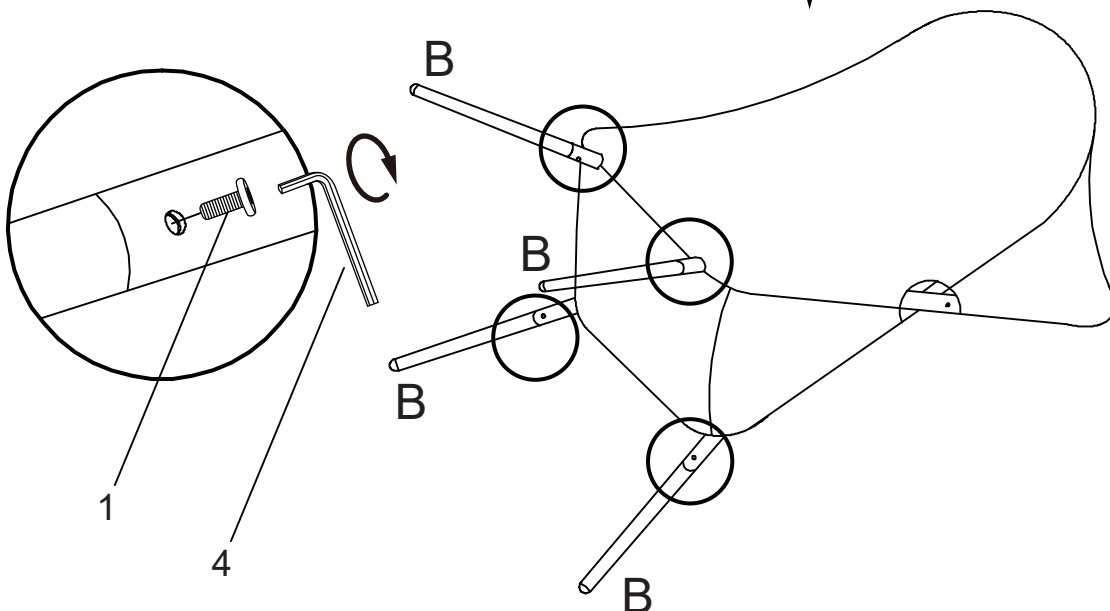



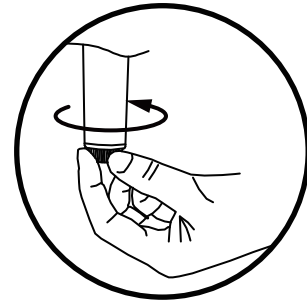
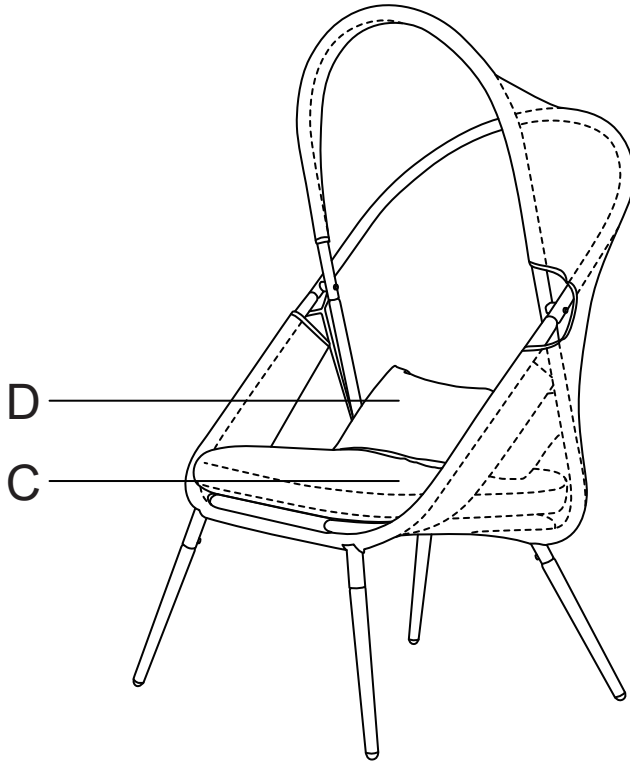

**x 2**

3

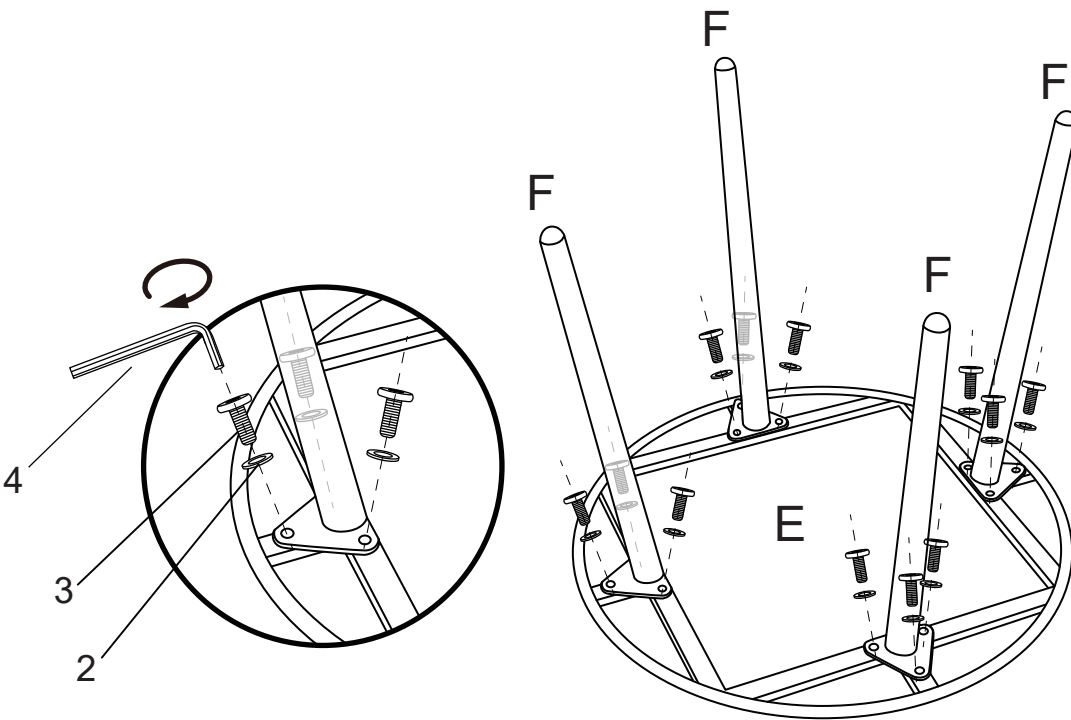

4



- 2  12x
  - 3  M6x10mm 12x
  - 4  1x
- 