

LETTI 120

21062023



60 min



HDPE LDPE

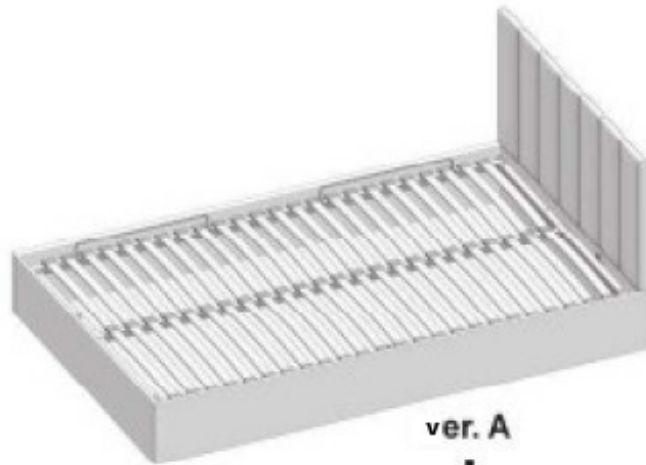

ver. A

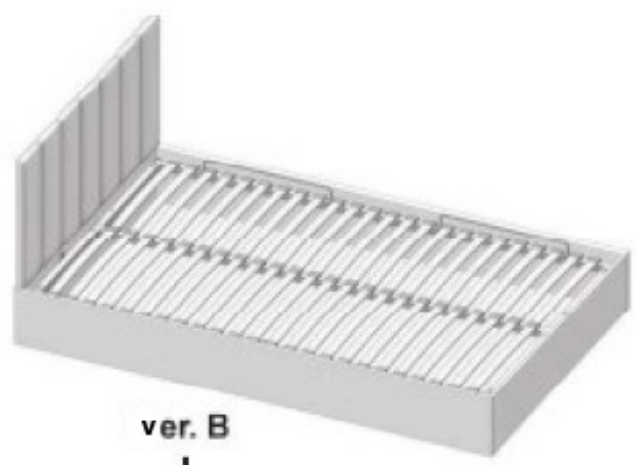

ver. B



str. 11



2x



4x

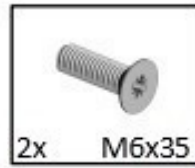

2x M6x35



1x

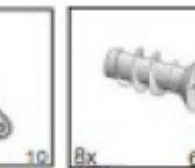

8x 6.3x16



16x M6x20

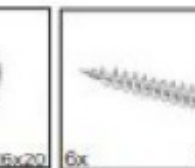

6x 4x20



6x M6x30



33x



8x M8



2x



2x



4x 4.5x30

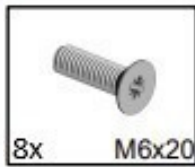

8x M6x20

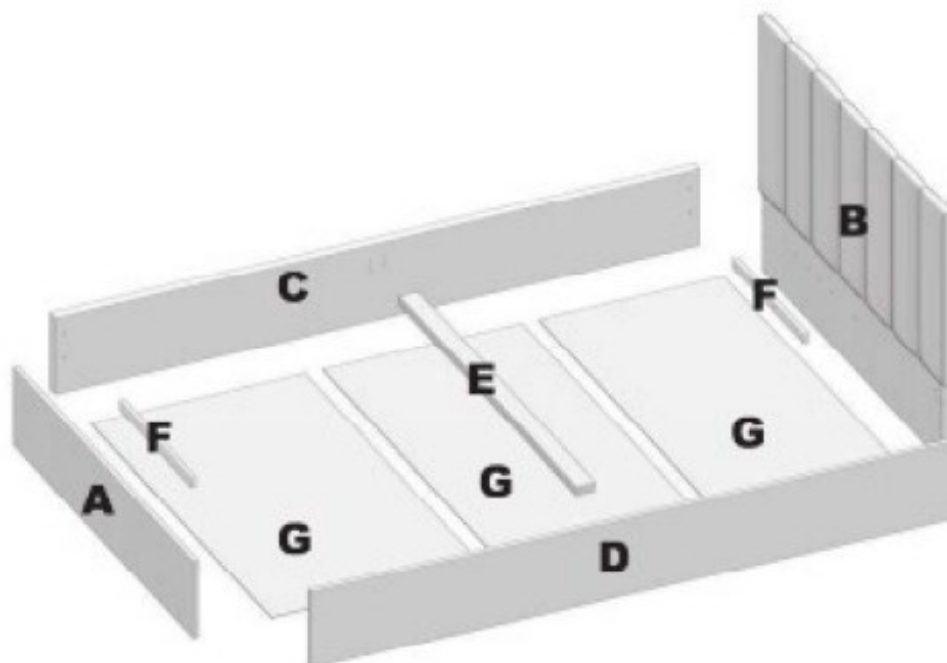

LETTI 120

4198462

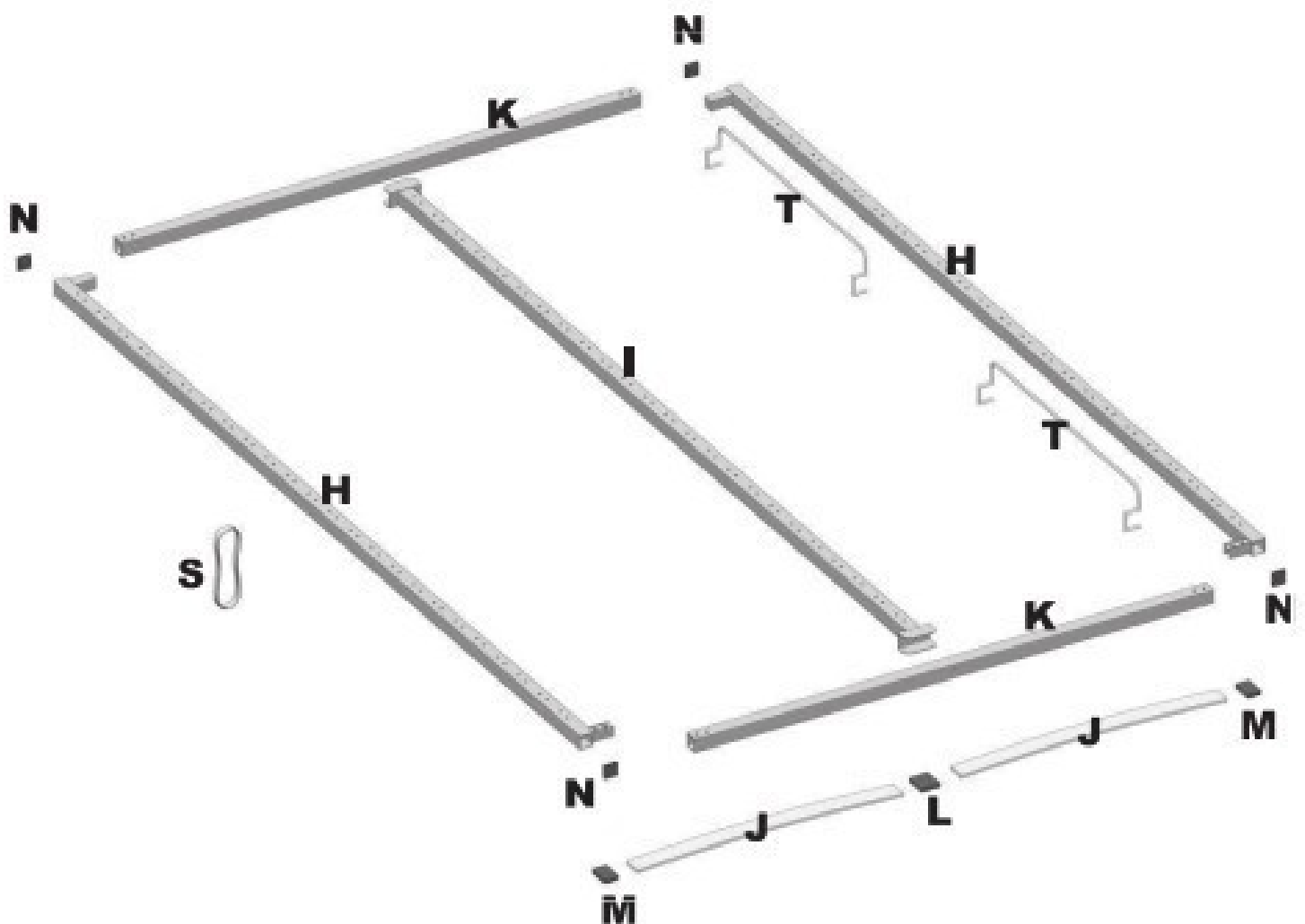
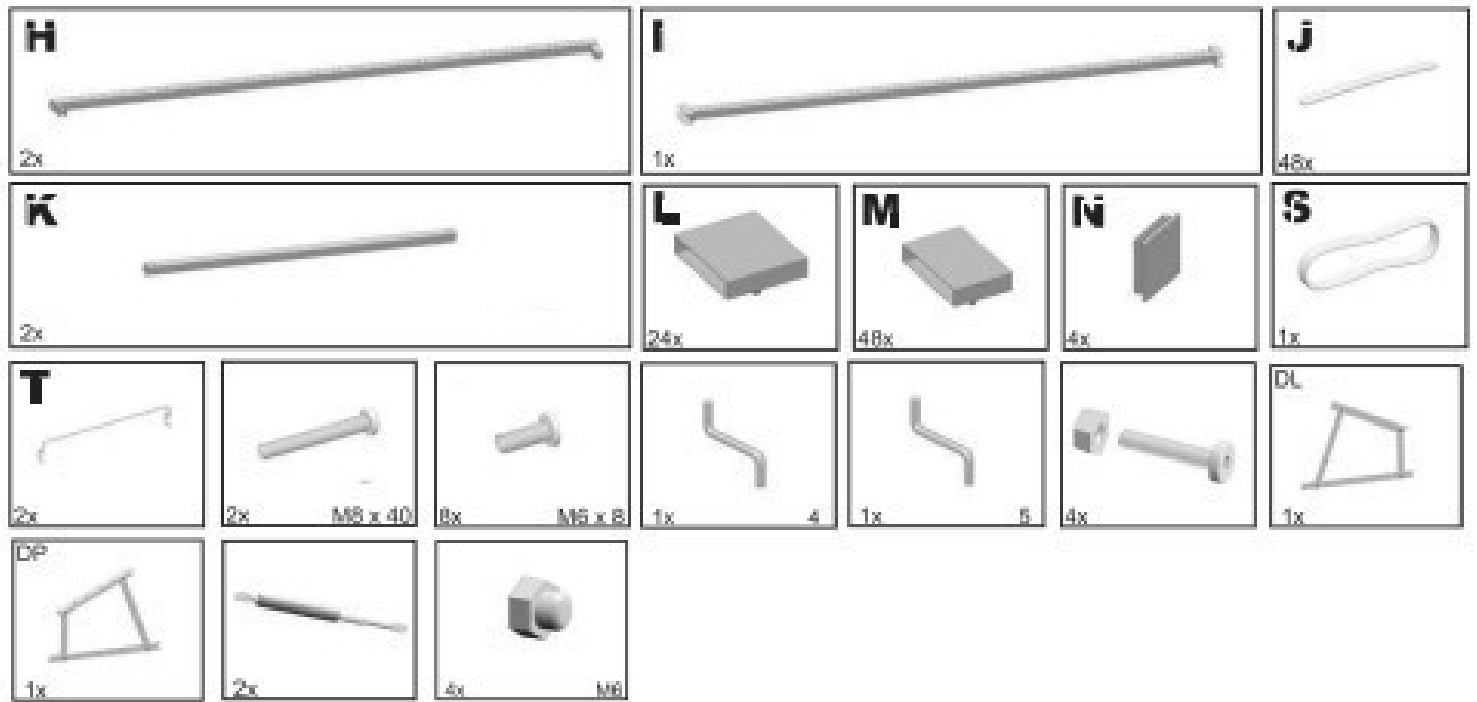

LETTI 120

1

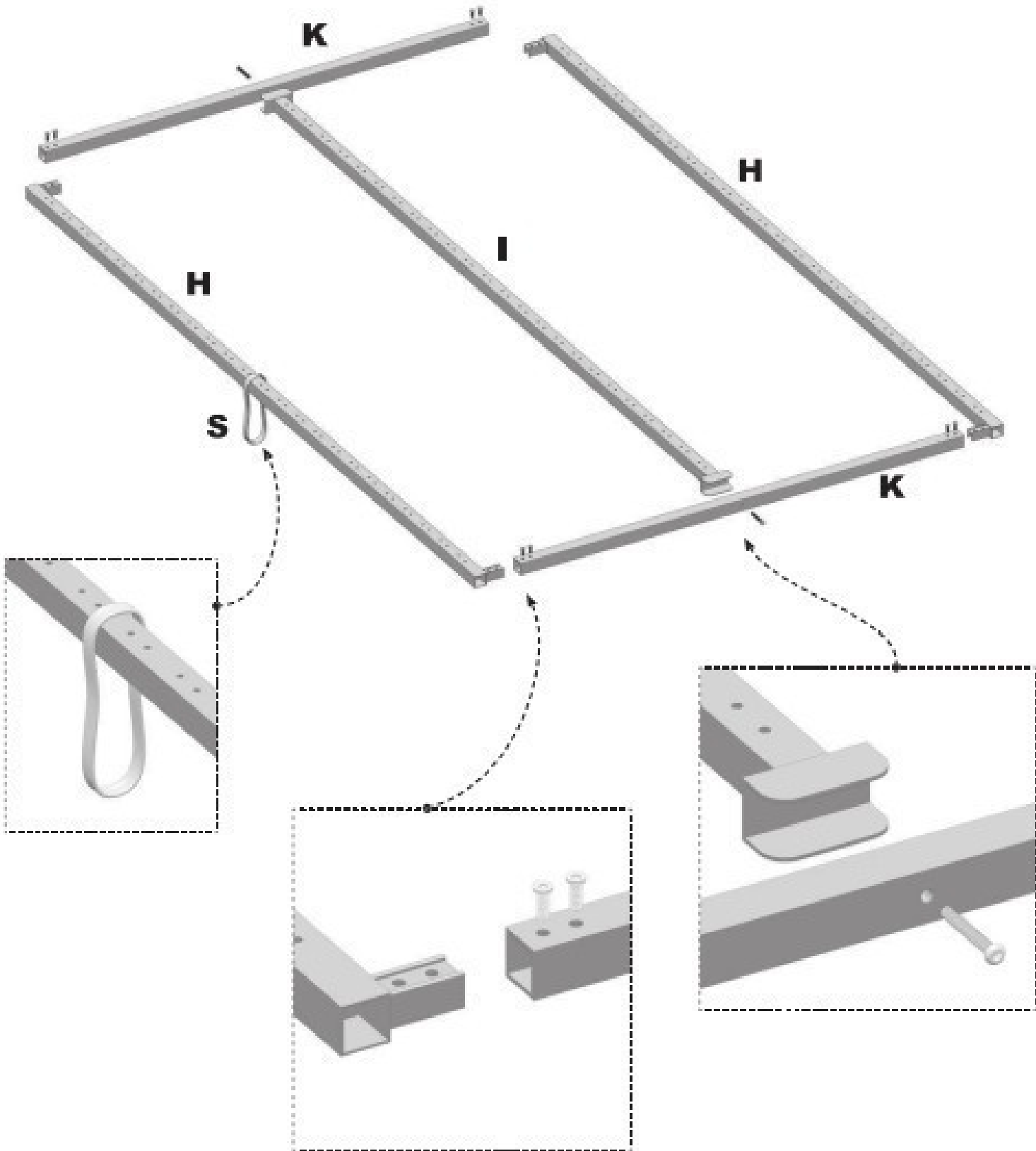

LETTI 120

21062023

2

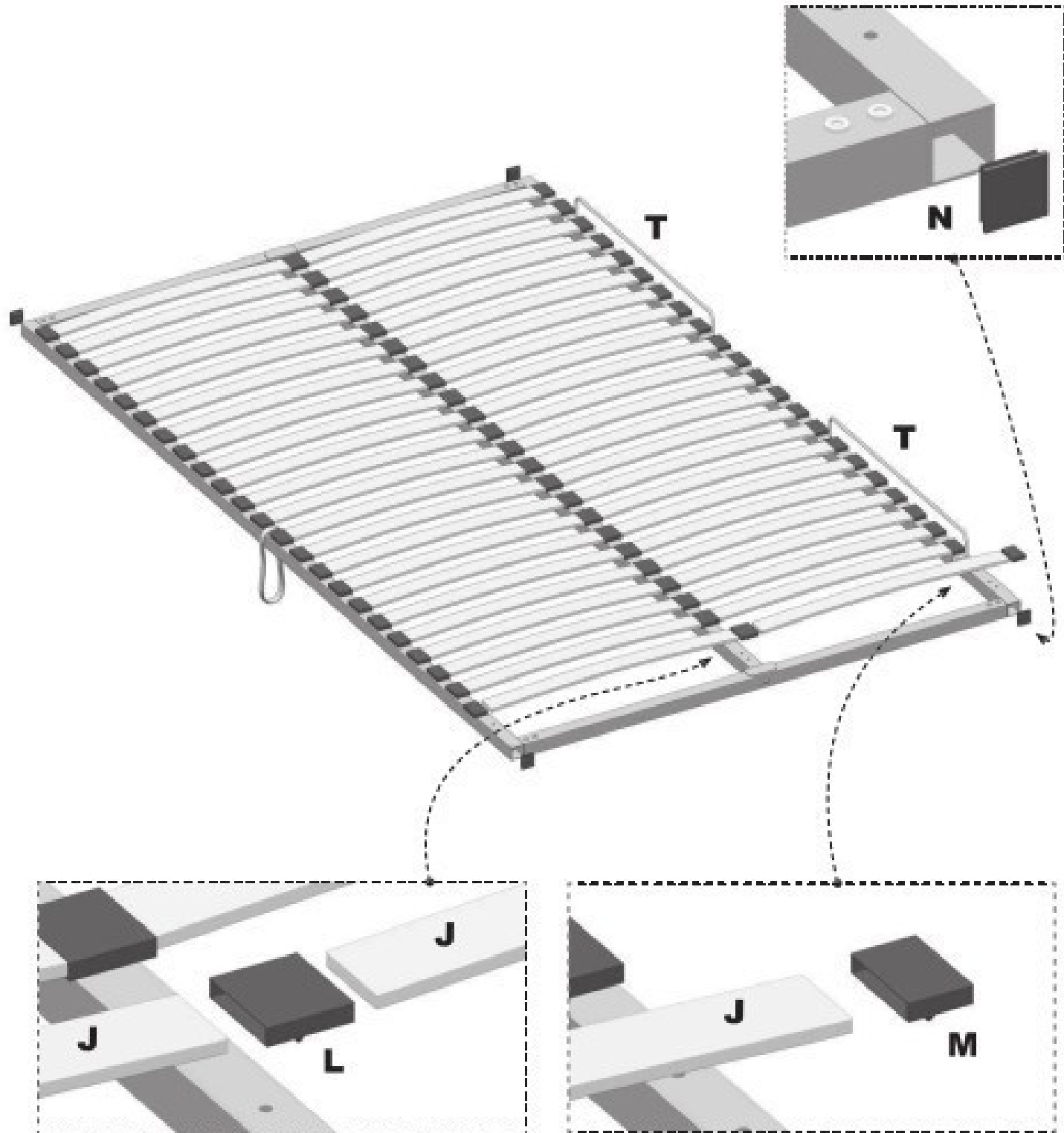
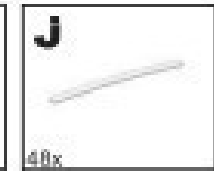
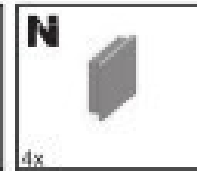
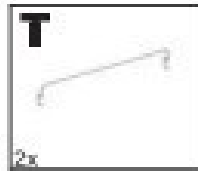

LETTI 120

21082023

3

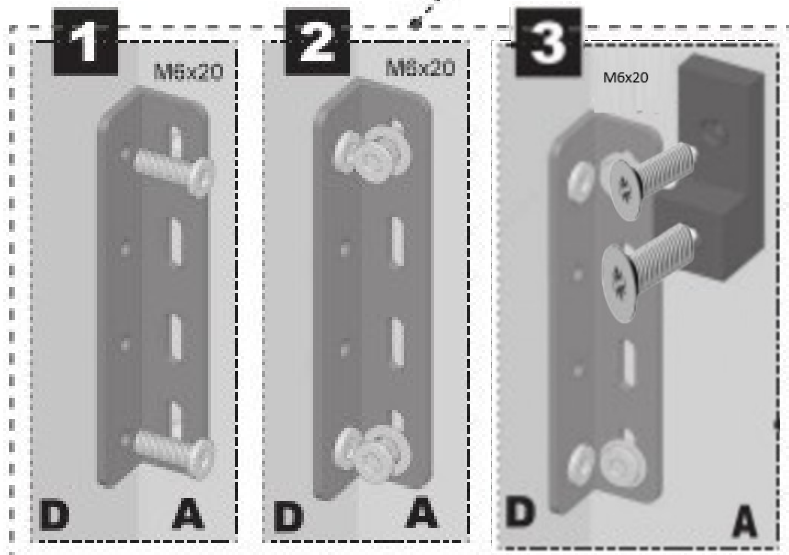
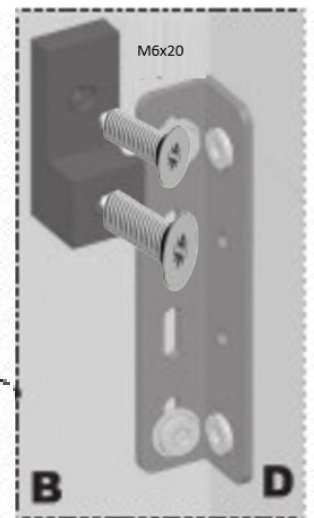
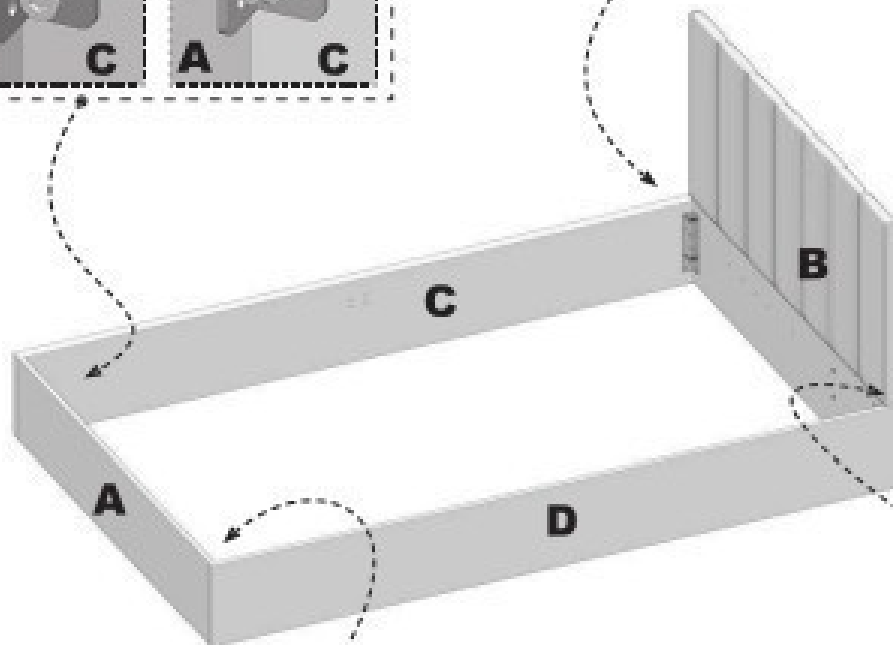
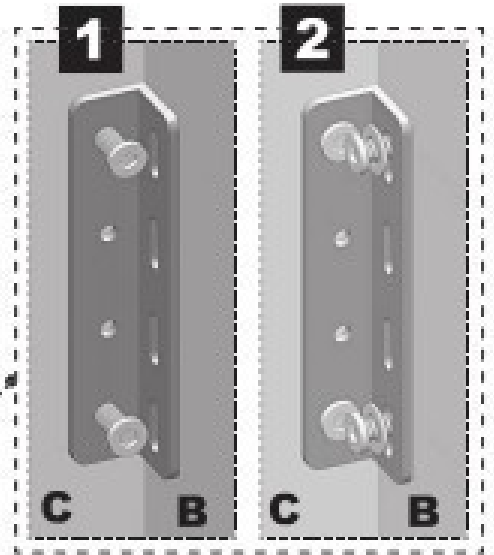
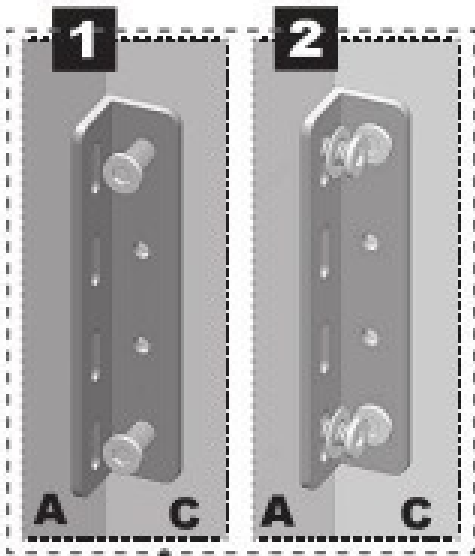
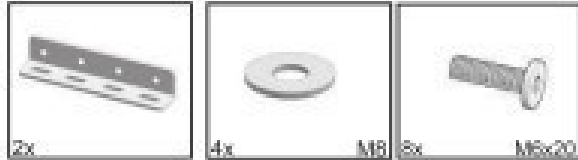

LETTI 120

21/09/2023

4

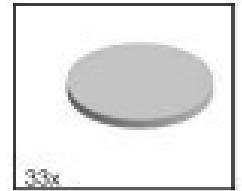
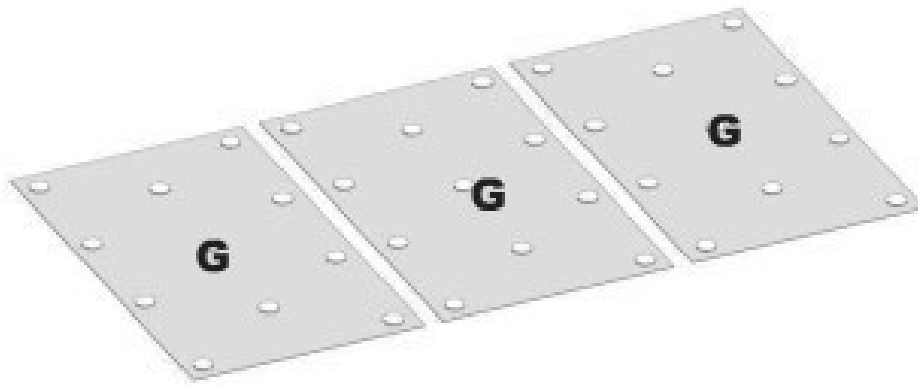

5

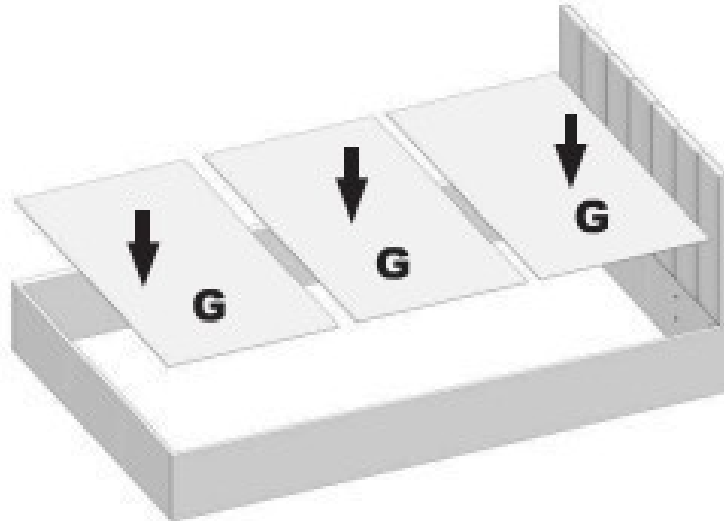

6

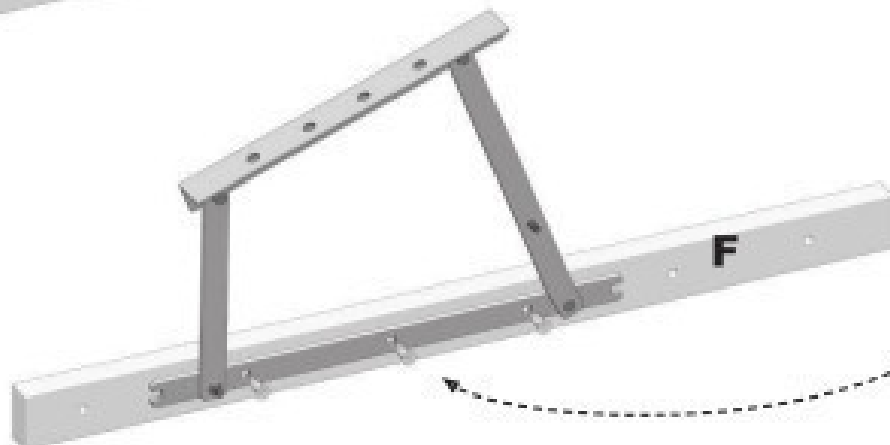
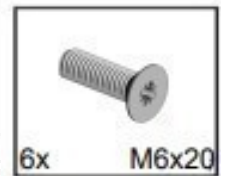
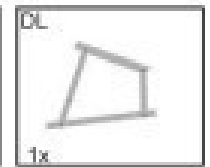
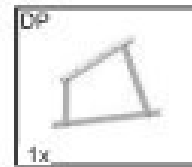

6/14

LETTI 120

7

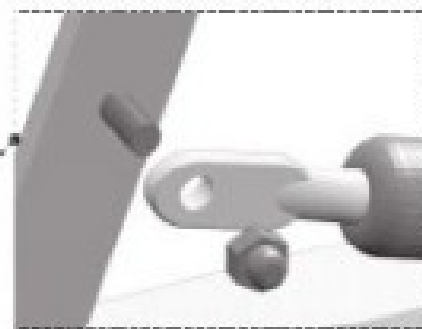
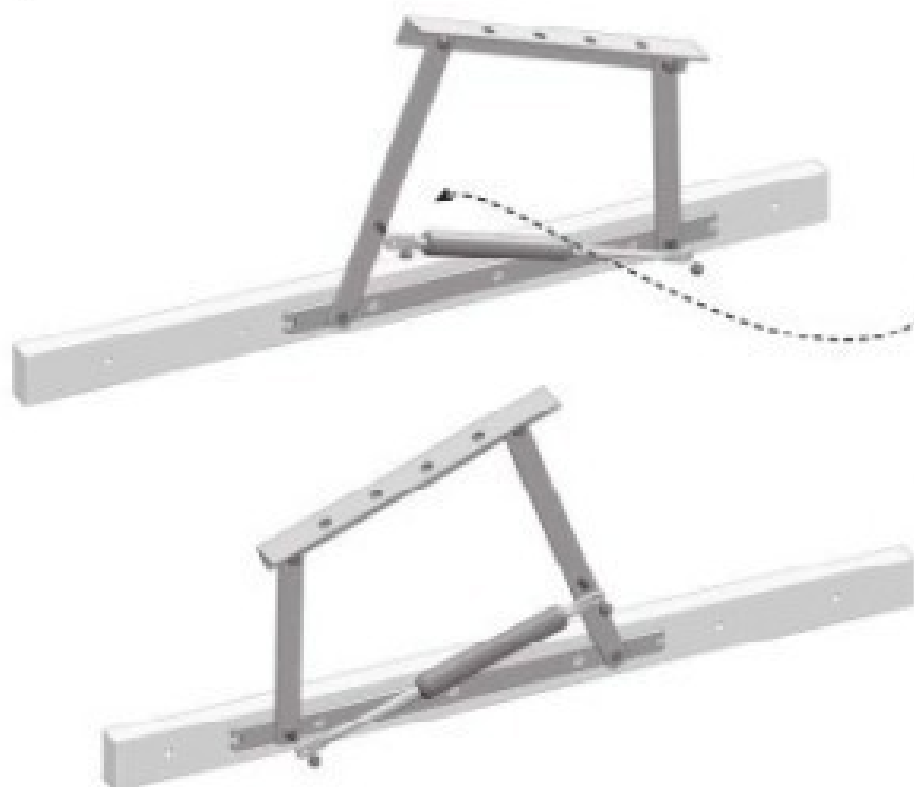

8 a

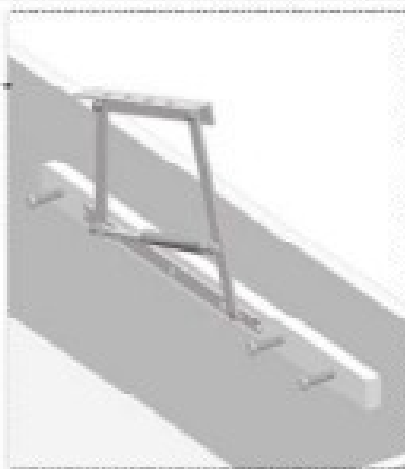
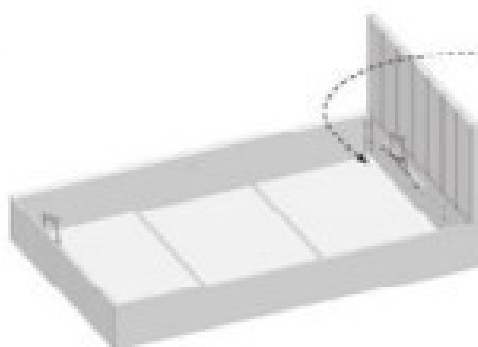

8 b

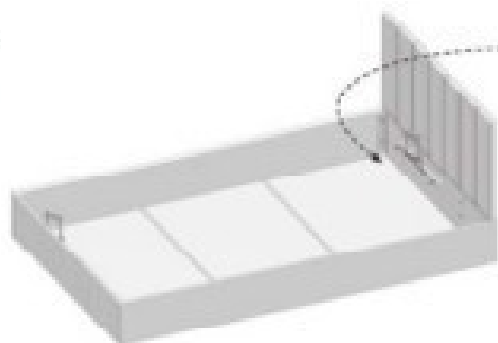

LETTI 120

21082023

9

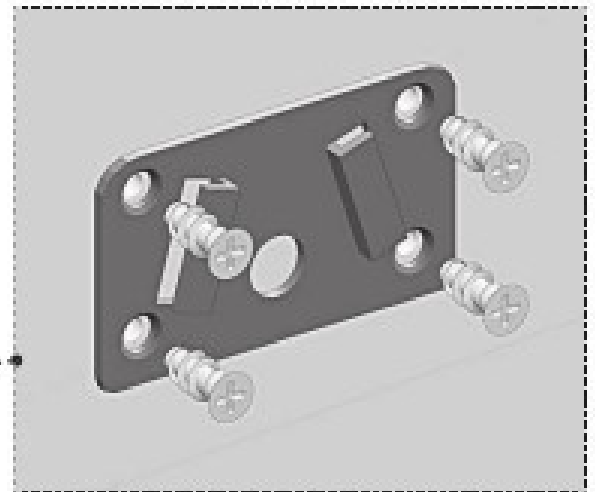
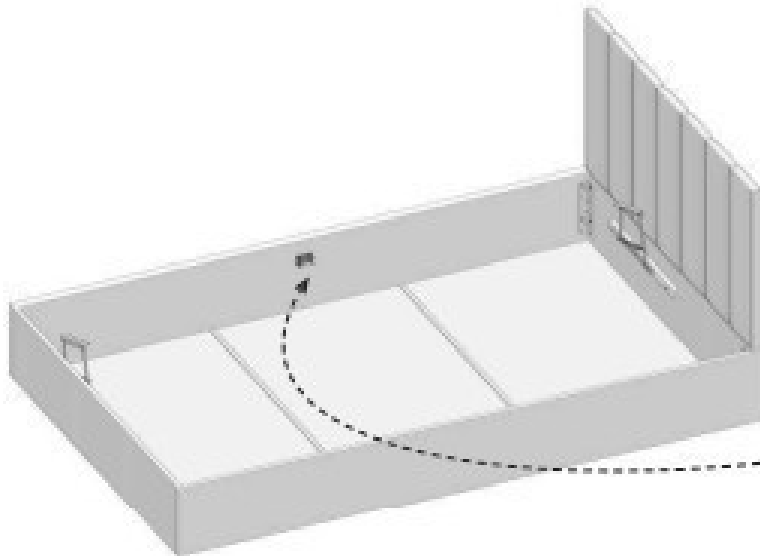

10

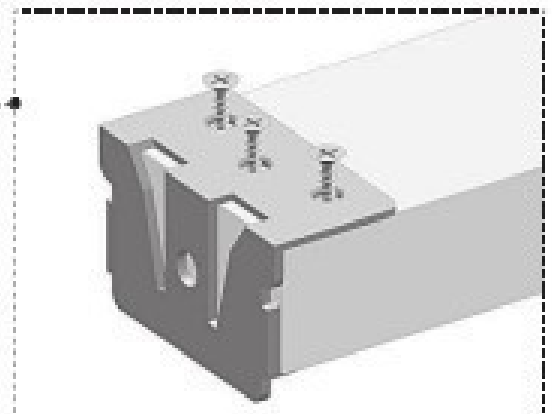
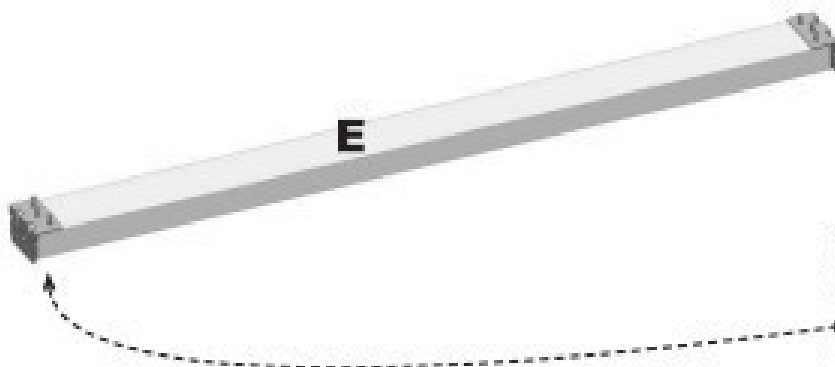
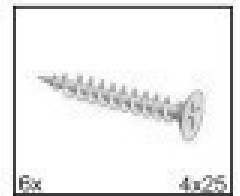

LETTI 120

11

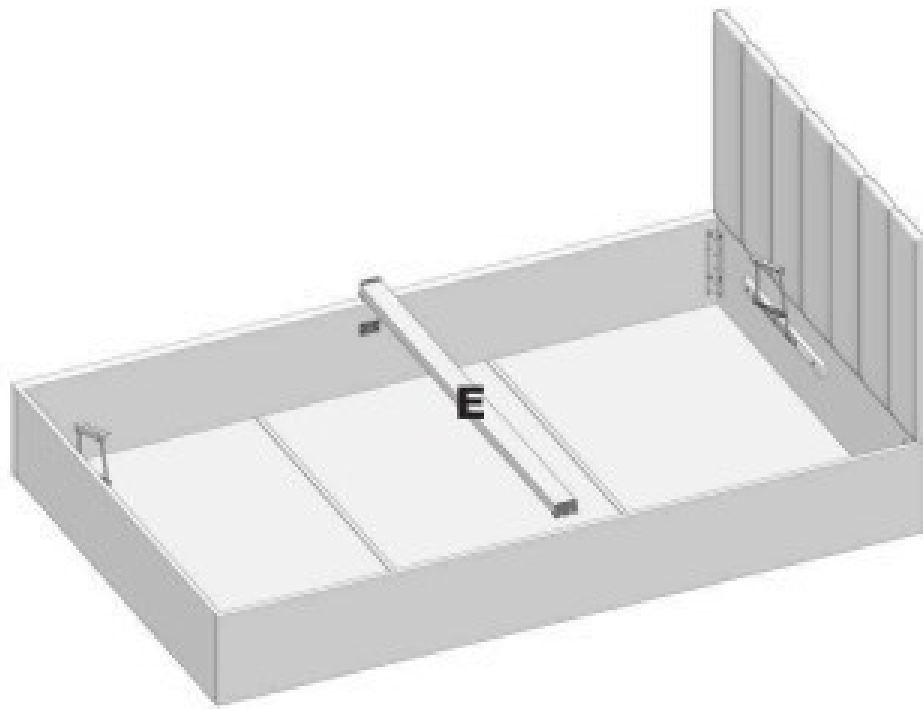

12

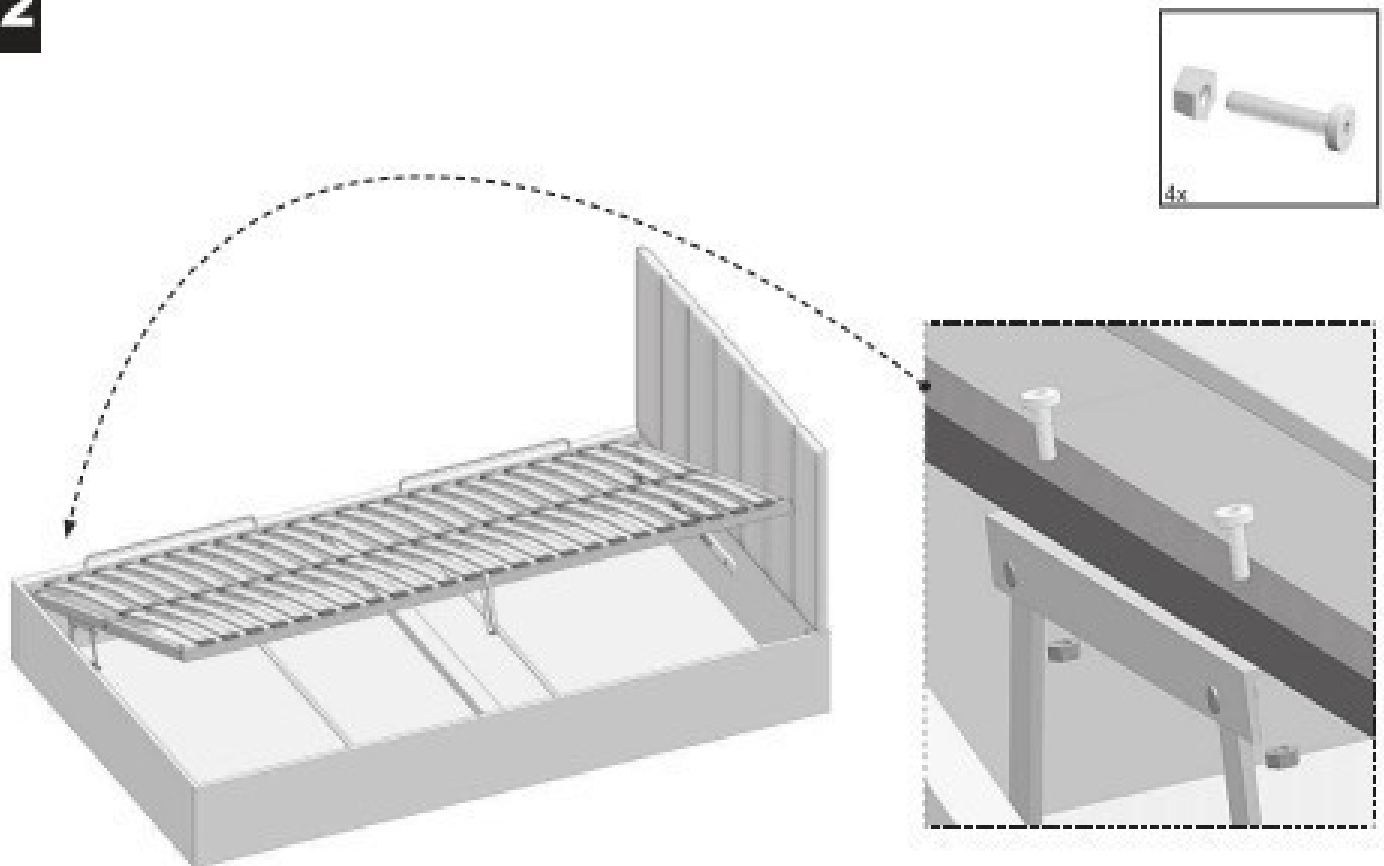

LETTI 120

21052023

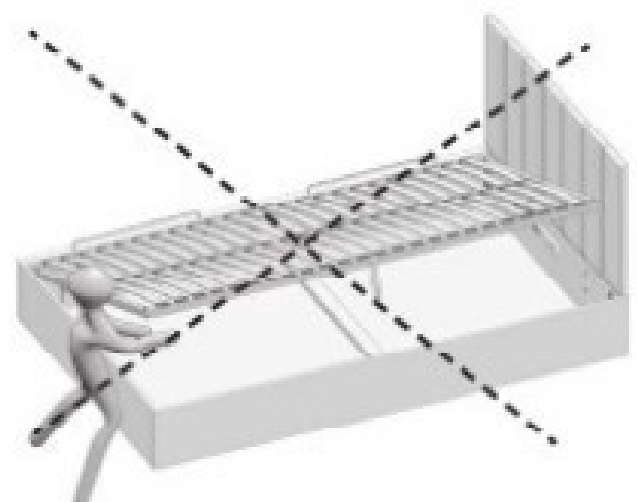
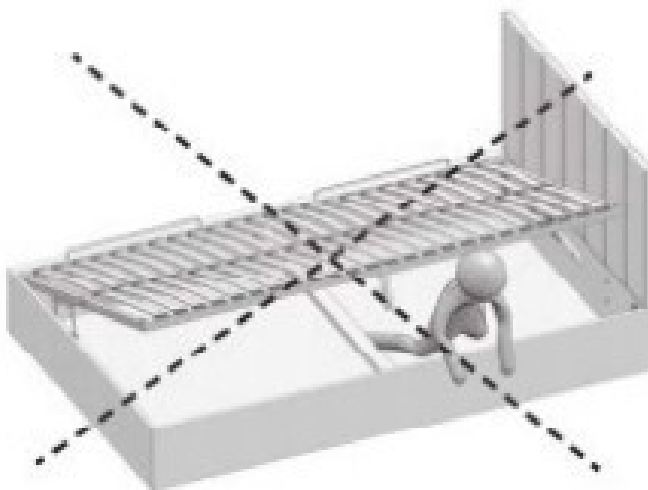
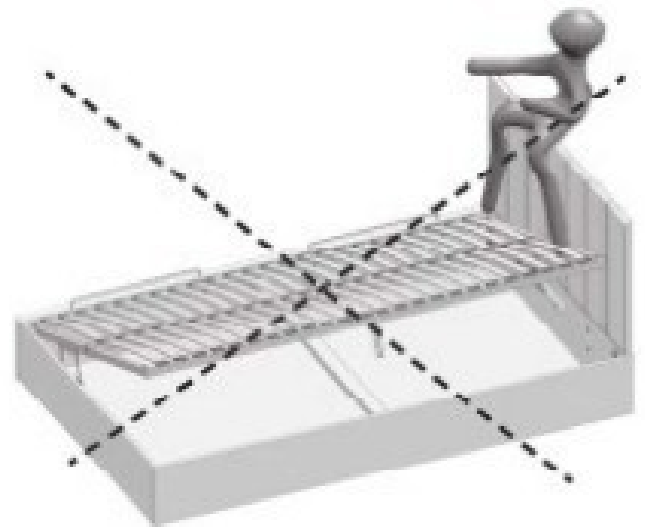
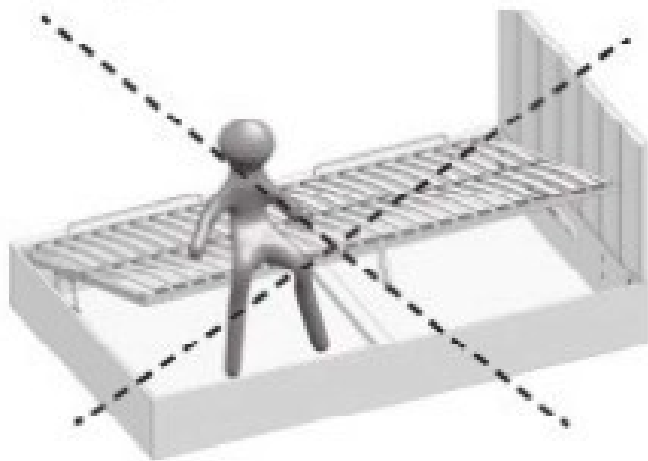
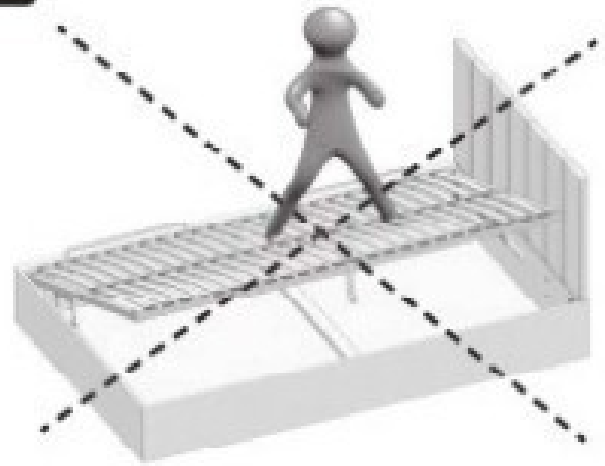
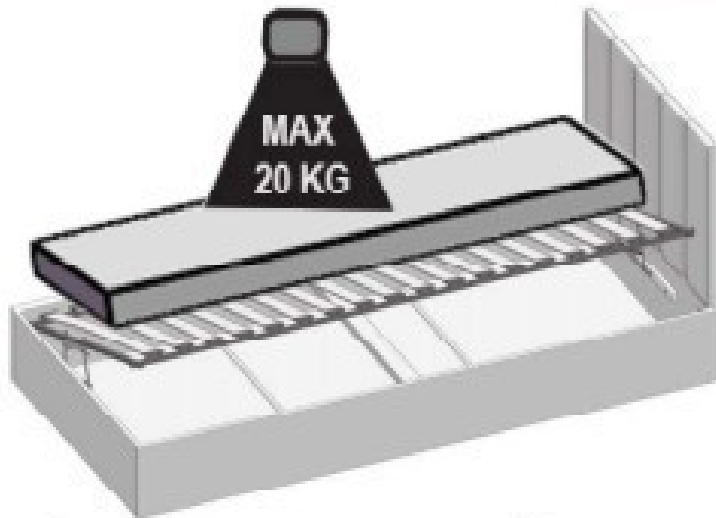

LETTI 120

31/08/2023

7

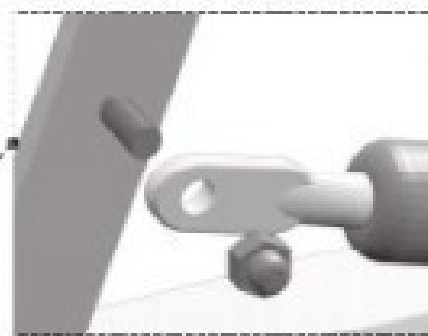
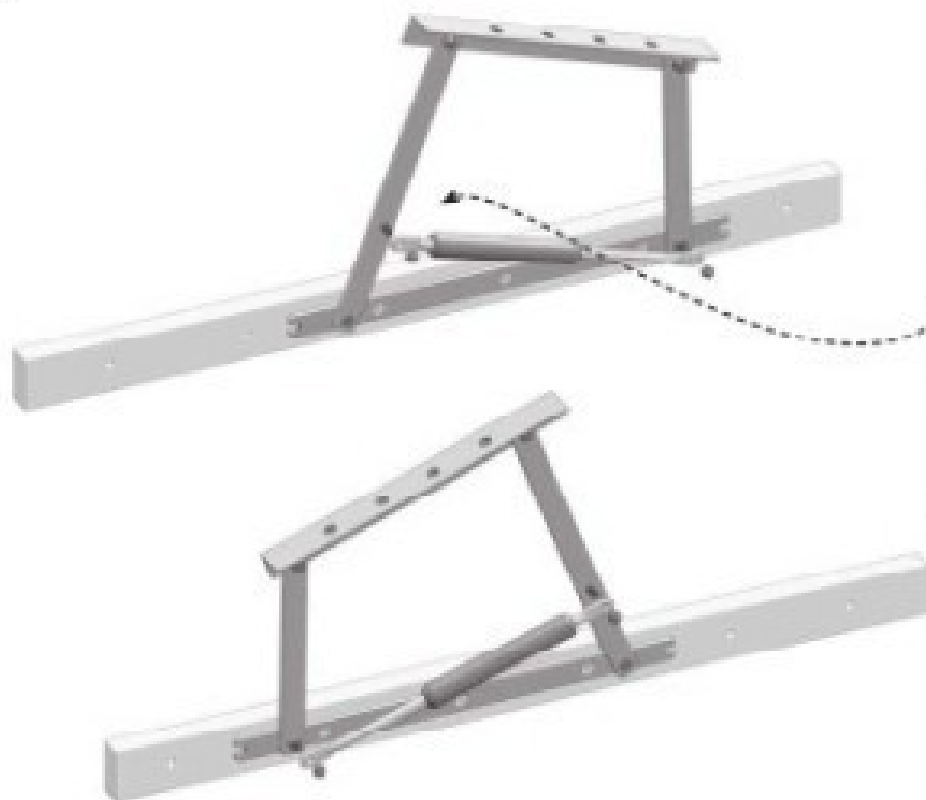

8 a

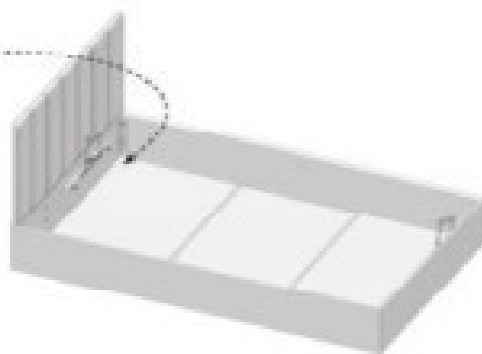

8 b

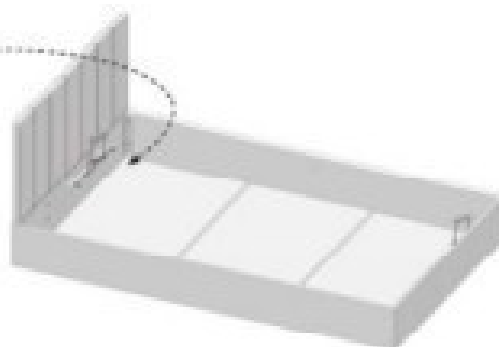

LETTI 120

9

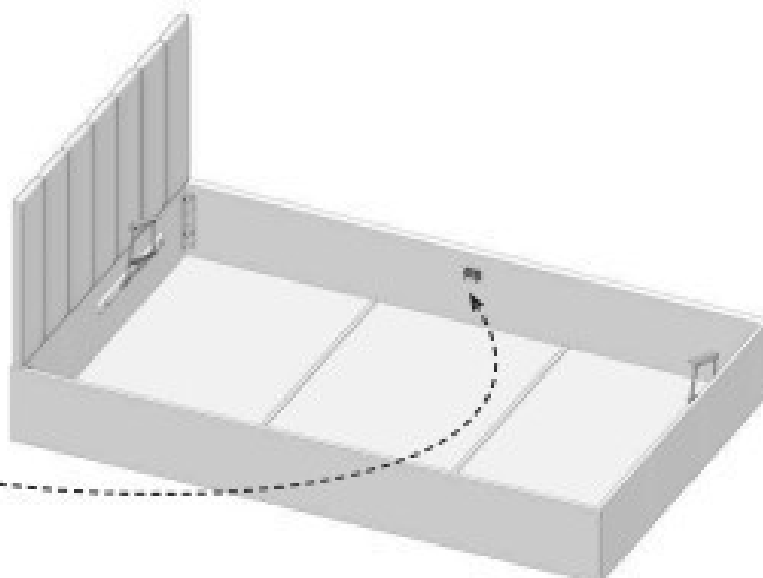

10

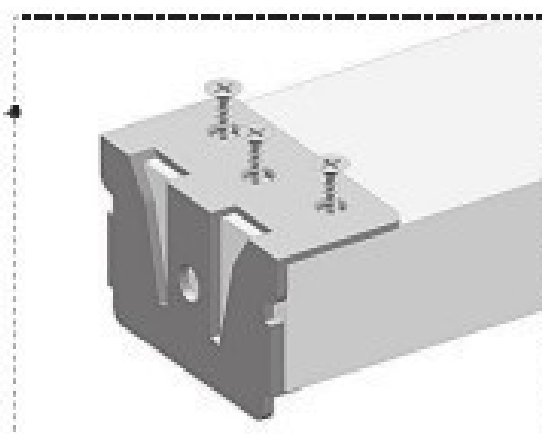
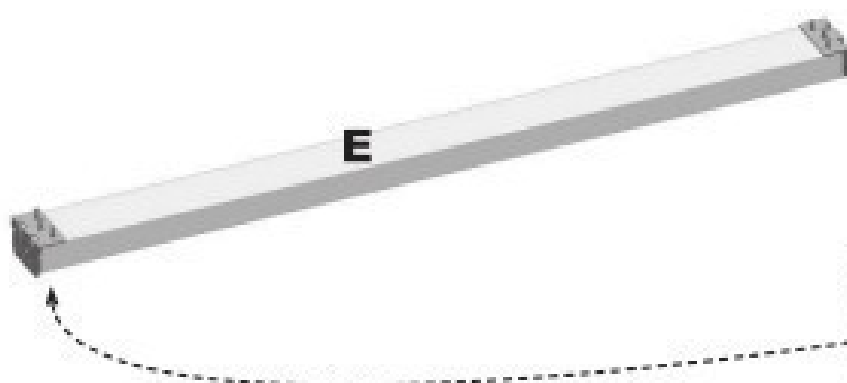
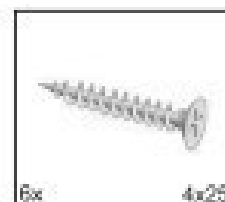

LETTI 120

2106/2023

11

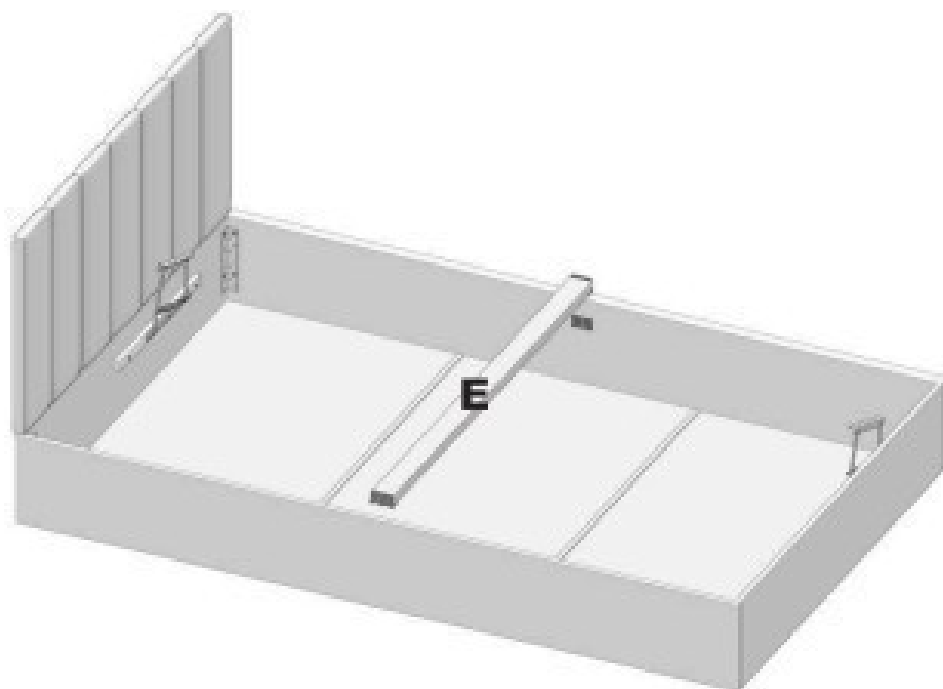

12

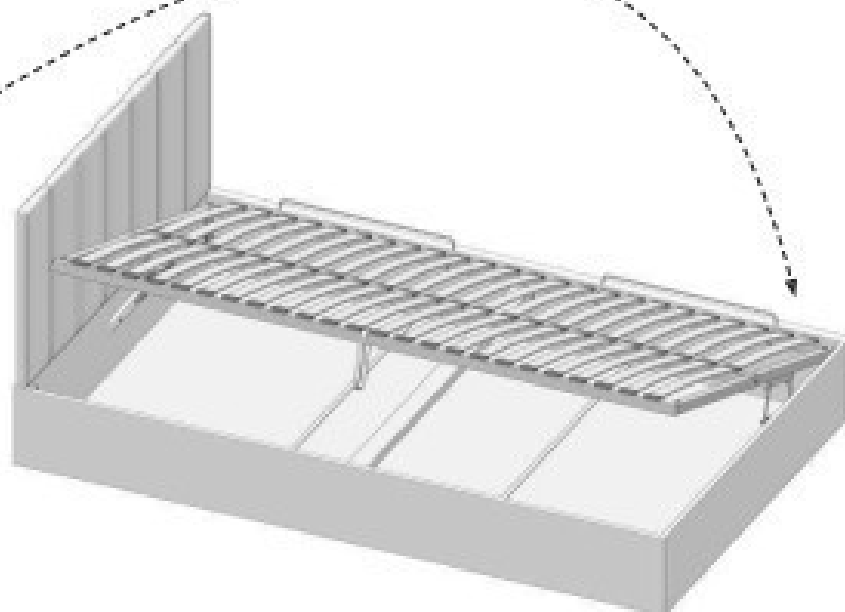

13/14

LETTI 120

71095503

