

BALOO

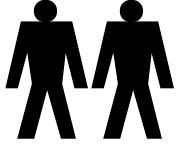

30min



PZ2 PH3

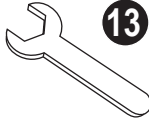

13

1 13



14 26

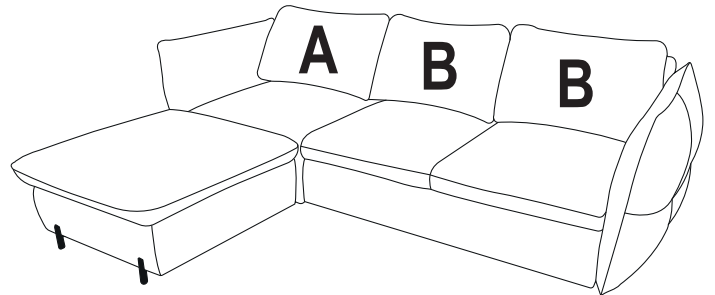
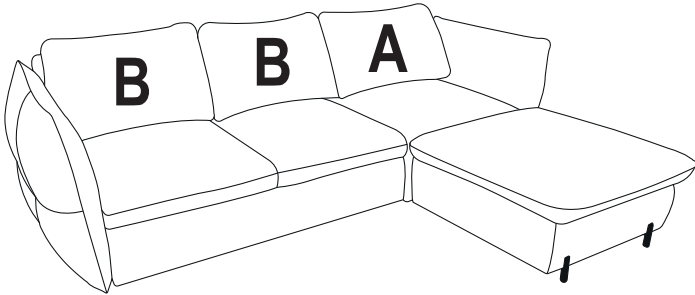
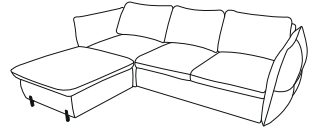

I

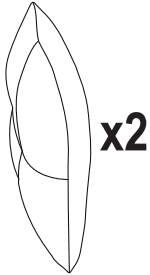

II

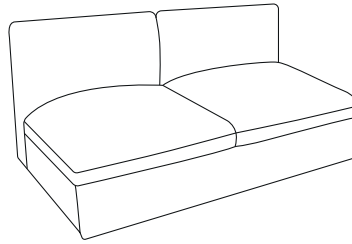

III

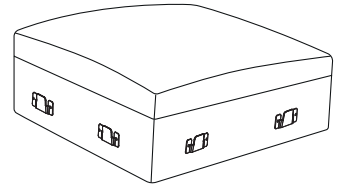

IV

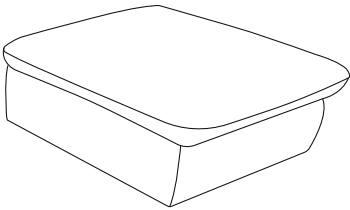

V



VI

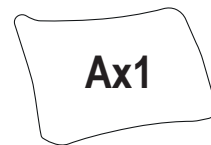

Cx2

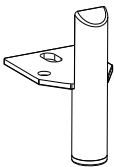

H=60/113 mm

Dx6

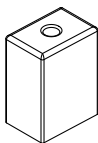

H=60 mm

Ex4

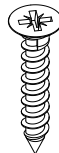

5x25



PZ2

Fx6



5x60



PZ2

Gx2

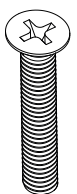

6x35



PH3

Hx2

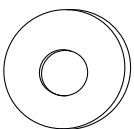

Ø6

Ix8

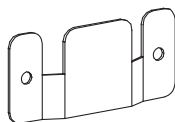

Jx16

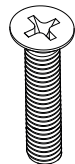

6x20



PH3

Kx6

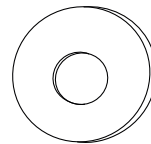

Ø10

Lx6

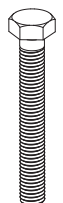

8x60

13

1

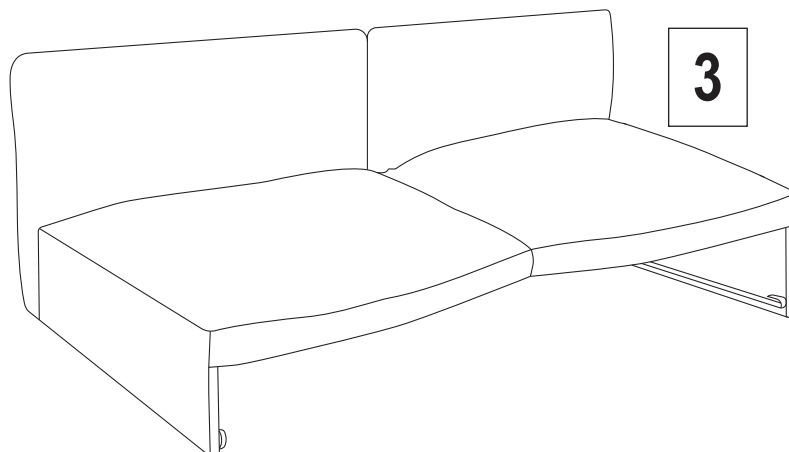
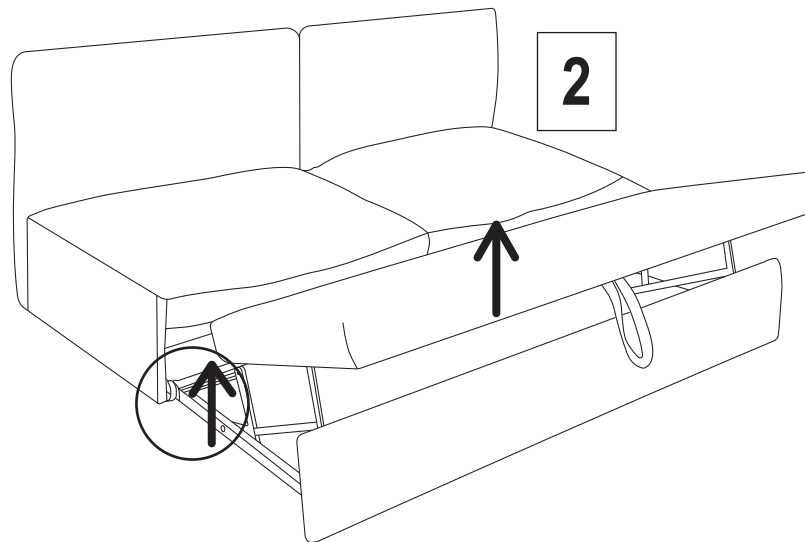
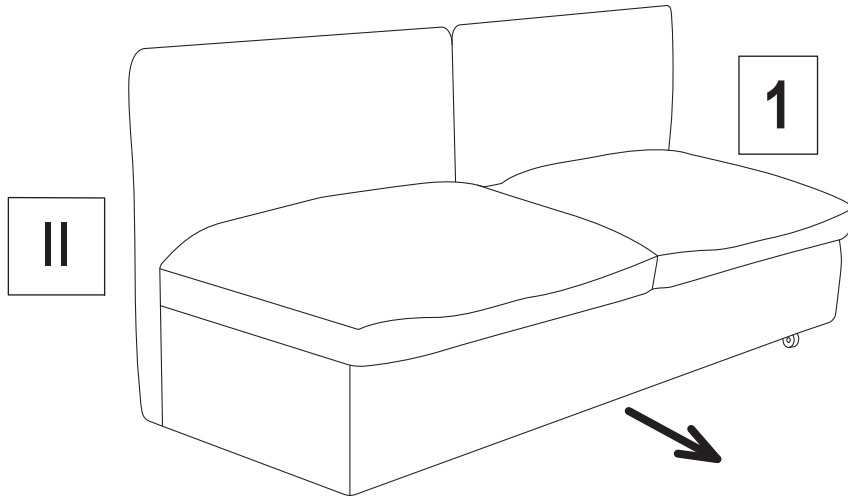

2

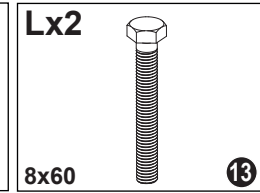
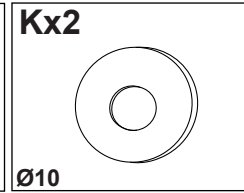
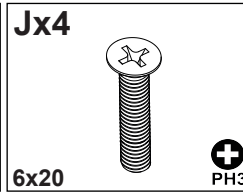
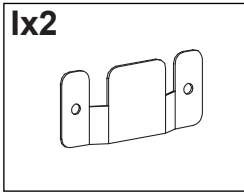

I

II

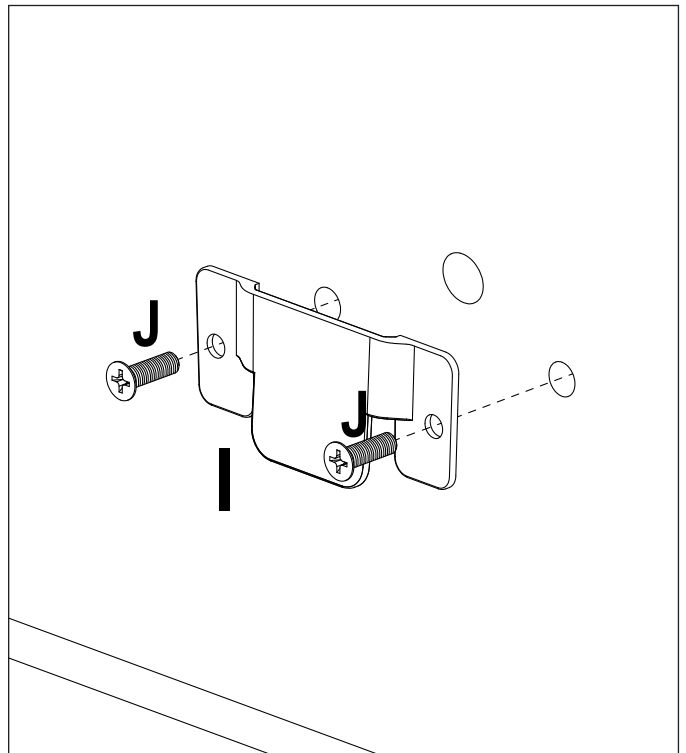
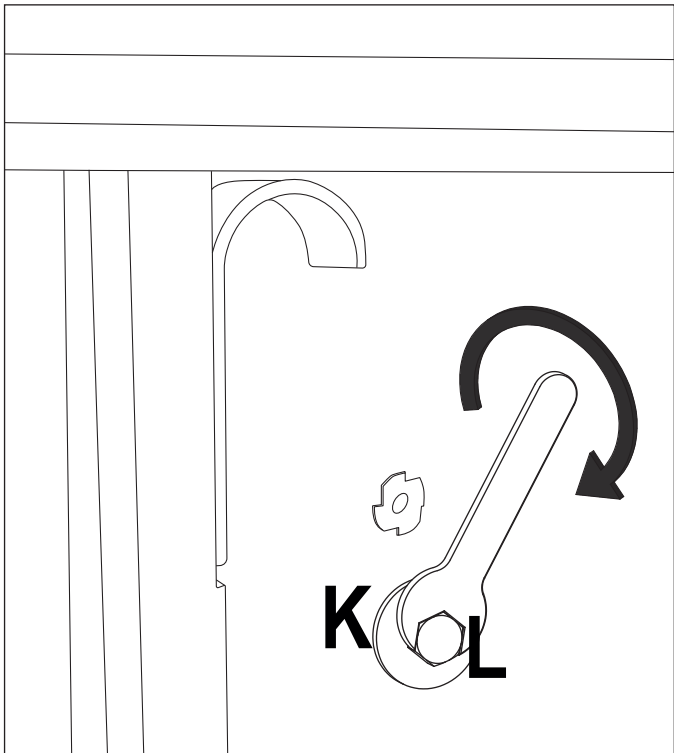
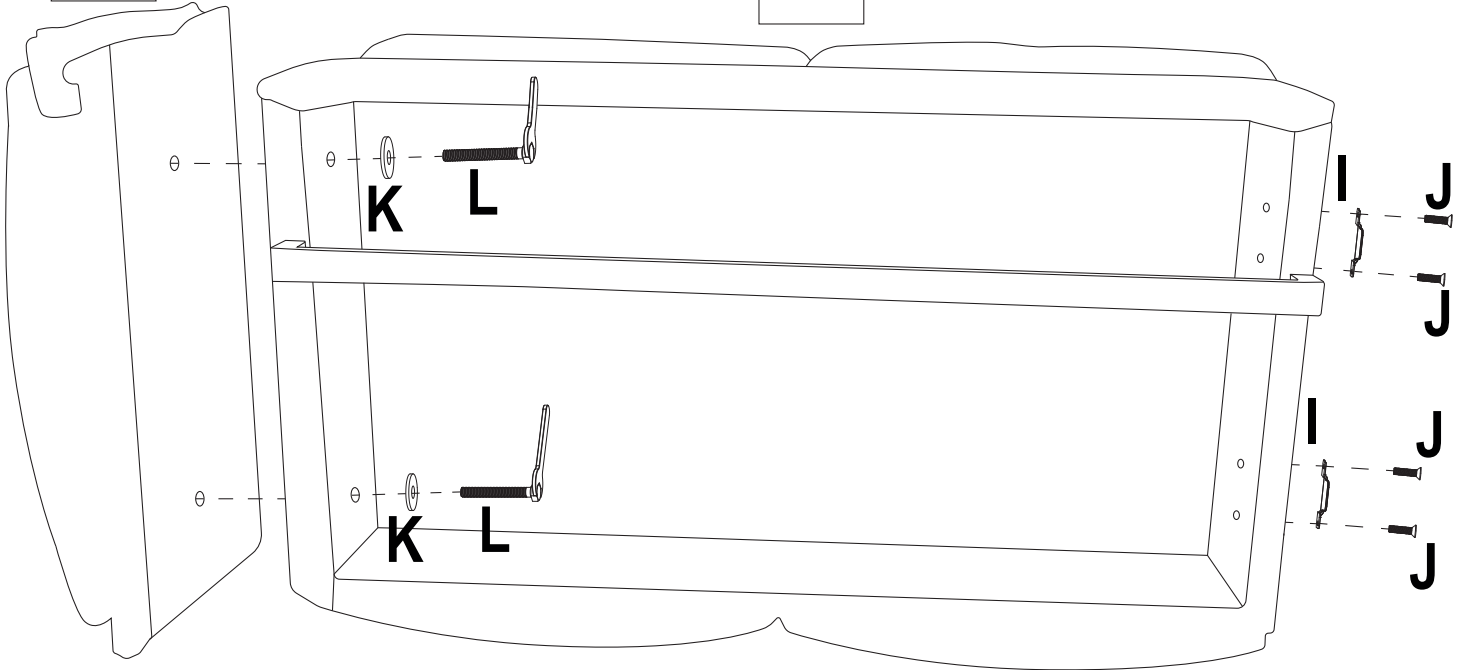

3

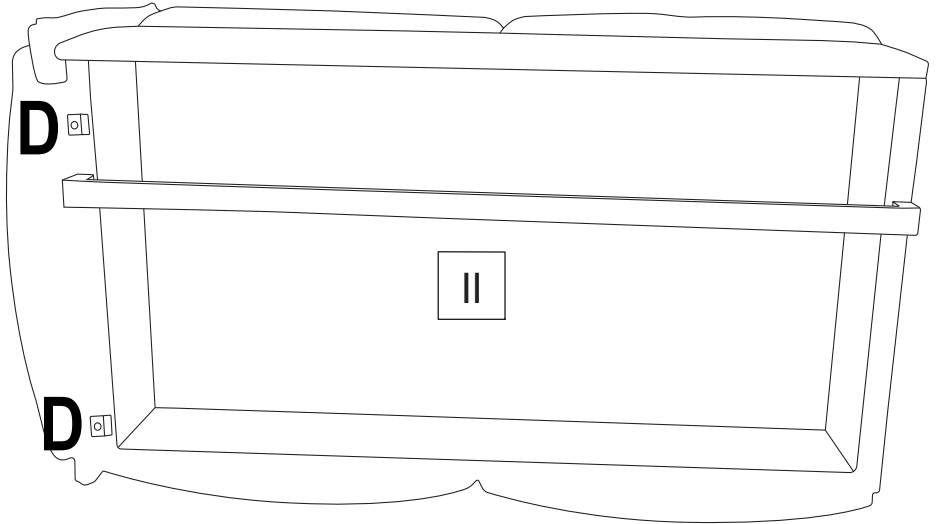
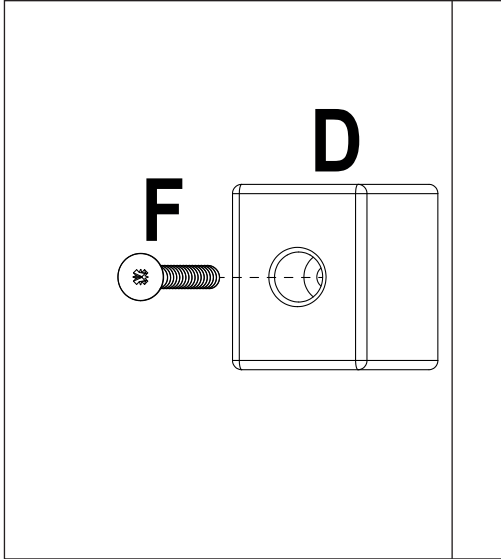
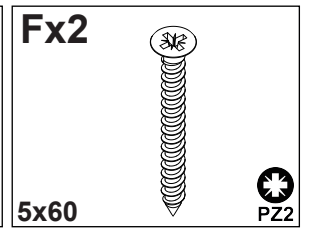
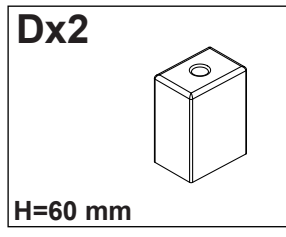

4

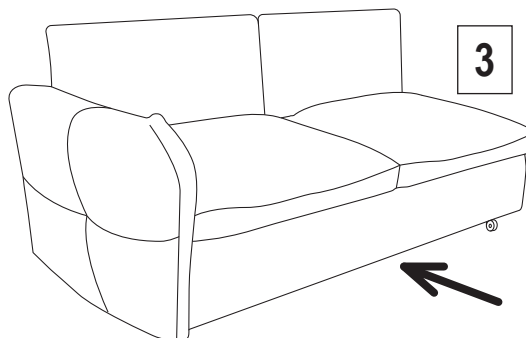
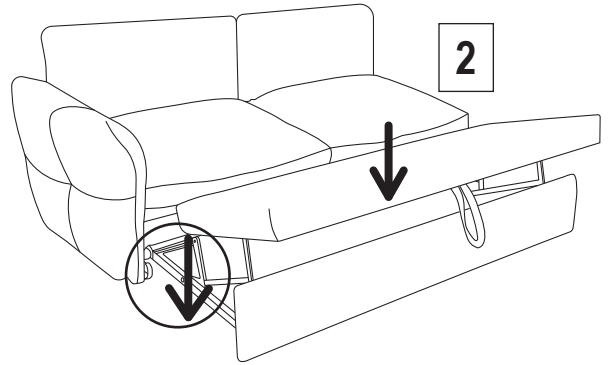
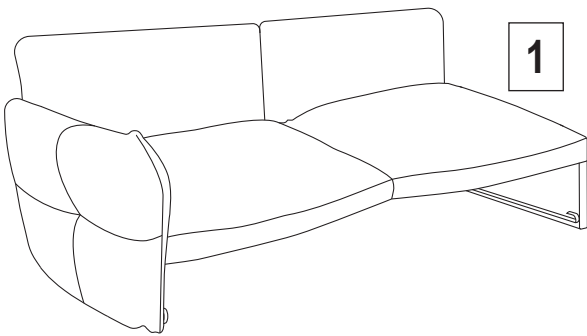

5

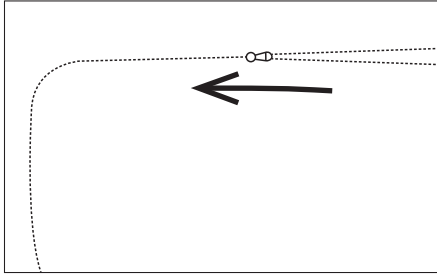

Kx2

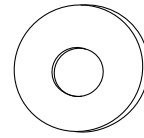

Ø10

Lx2

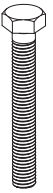

8x60

13

V

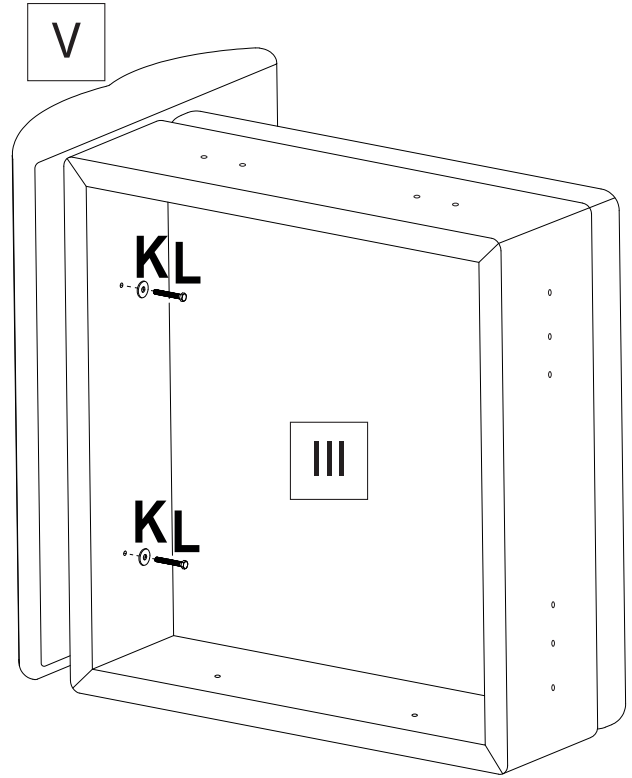
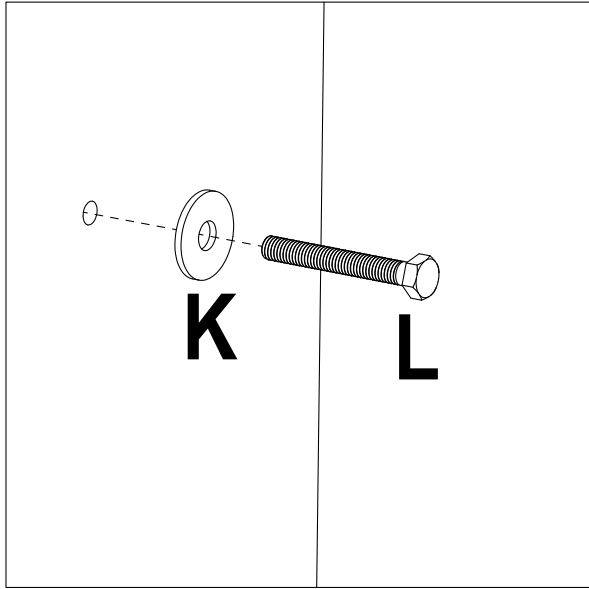

6

Ix4

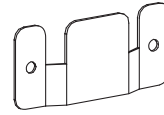

Jx8

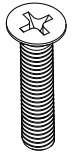

6x20

PH3

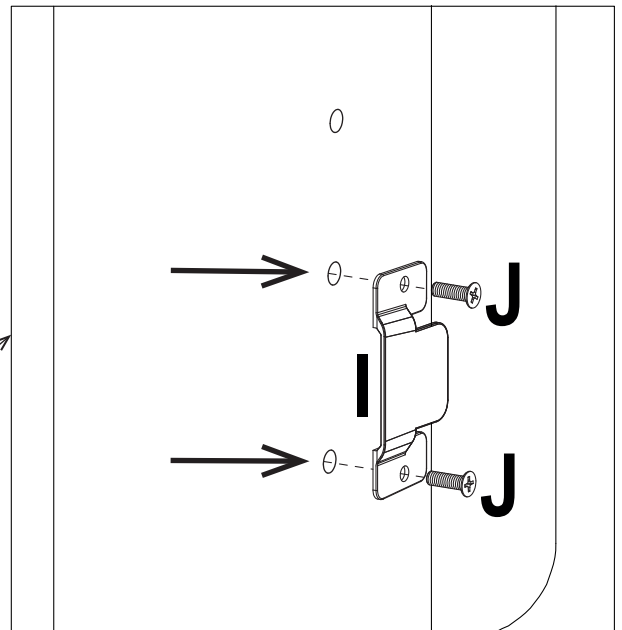
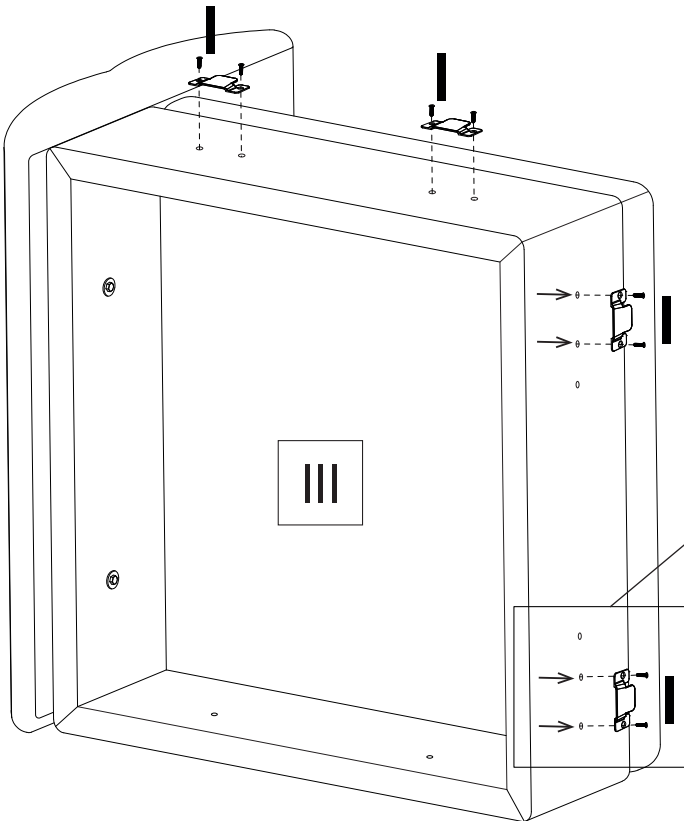

7

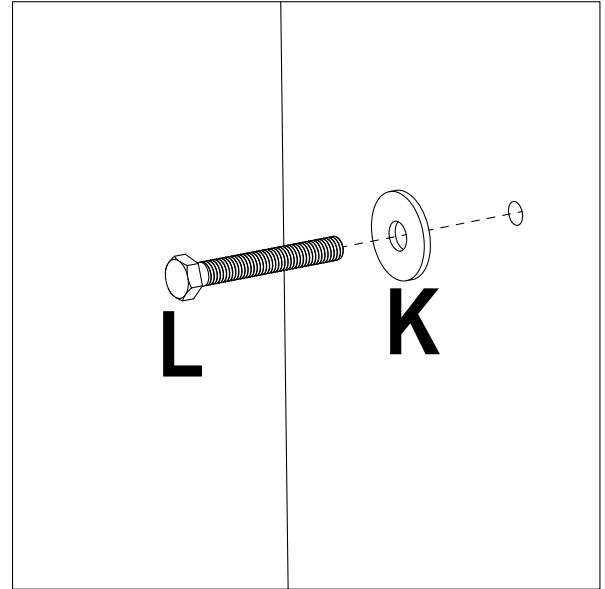
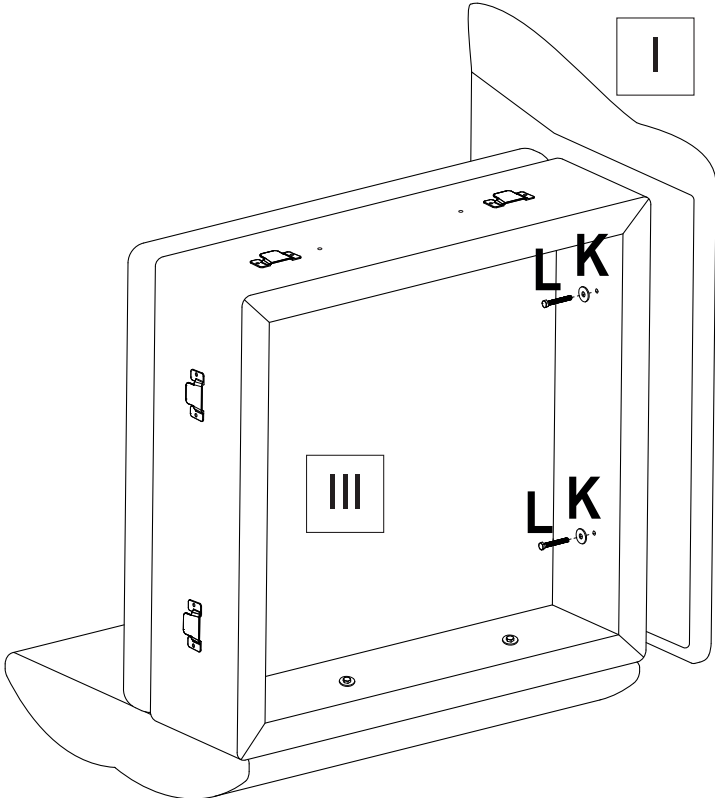
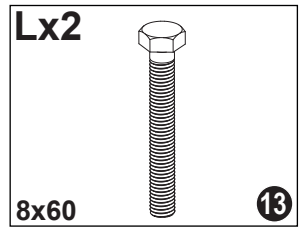
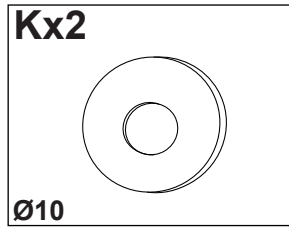

8

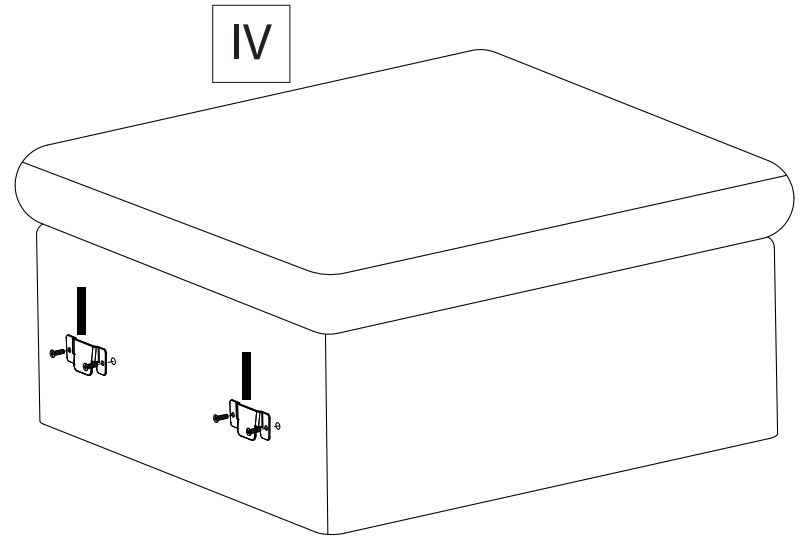
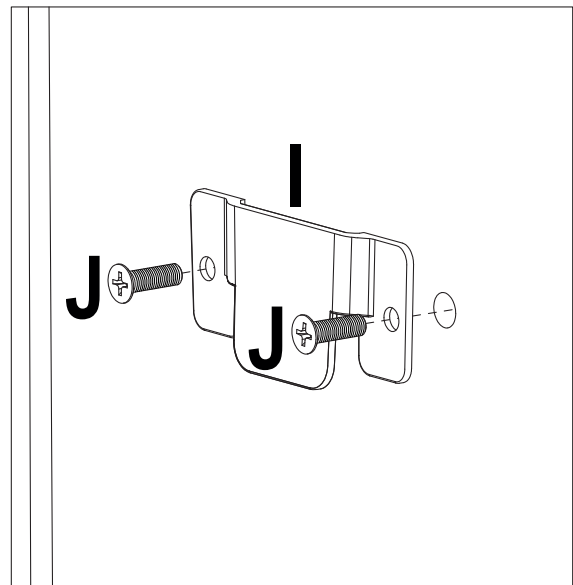
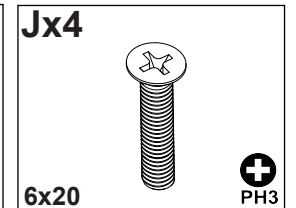
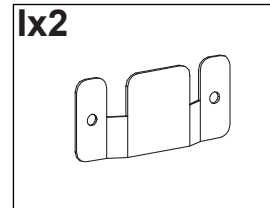

9

Cx2

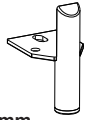

H=60/113 mm

Dx4

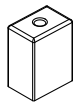

H=60 mm

Ex4



5x25



PZ2

Fx4



5x60



PZ2

Gx2



6x35



PH3

Hx2

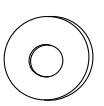

Ø6

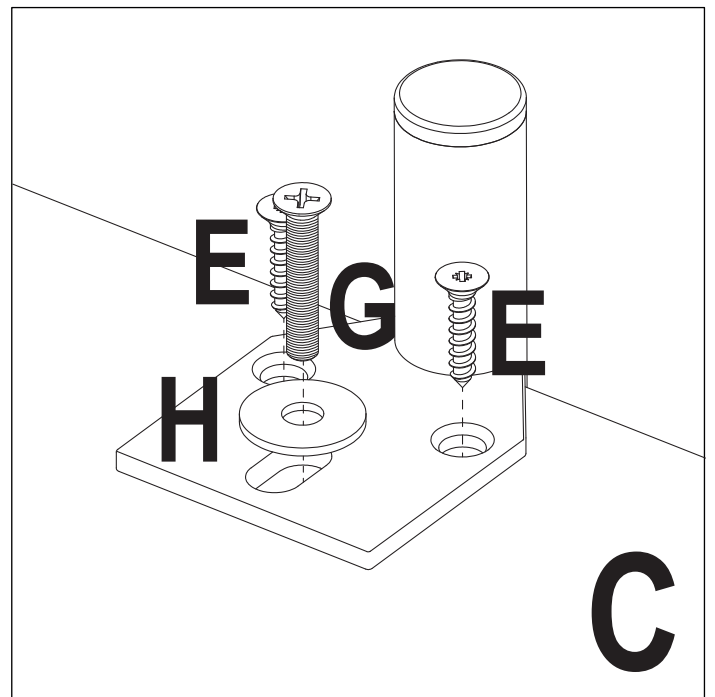
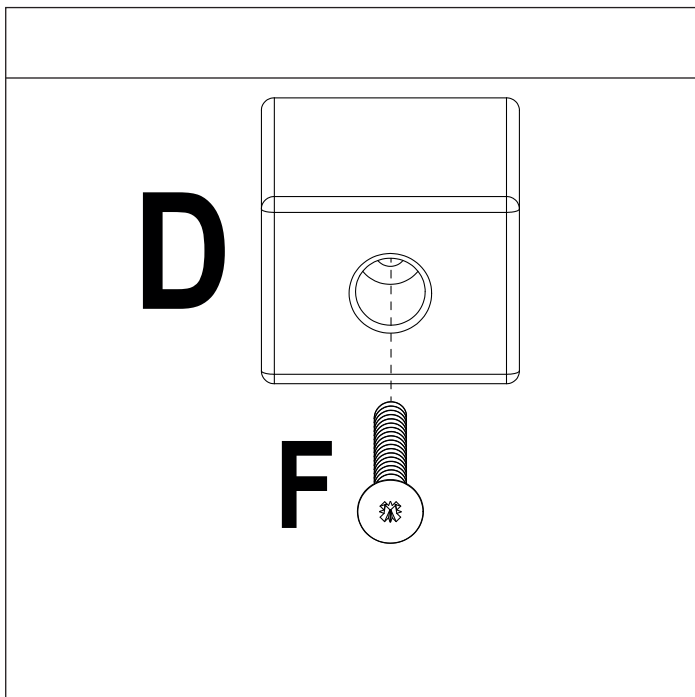
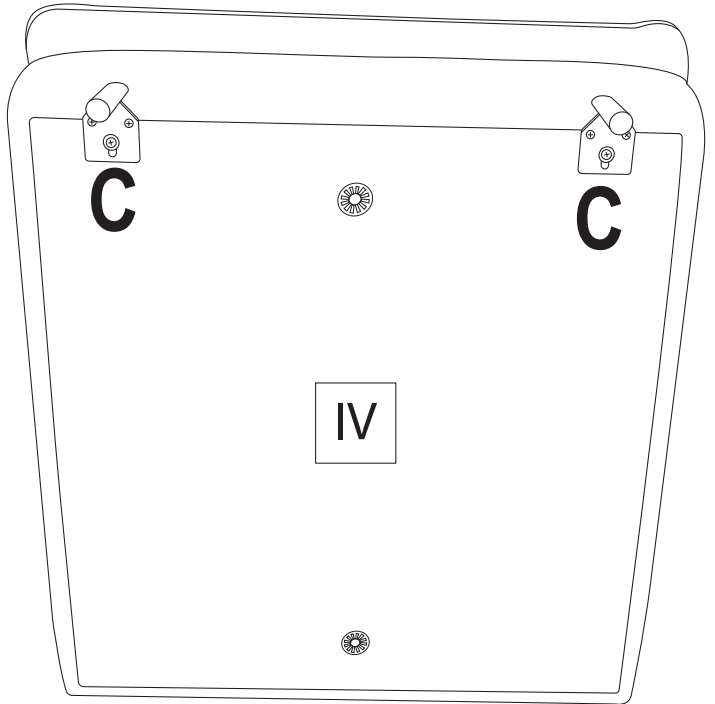
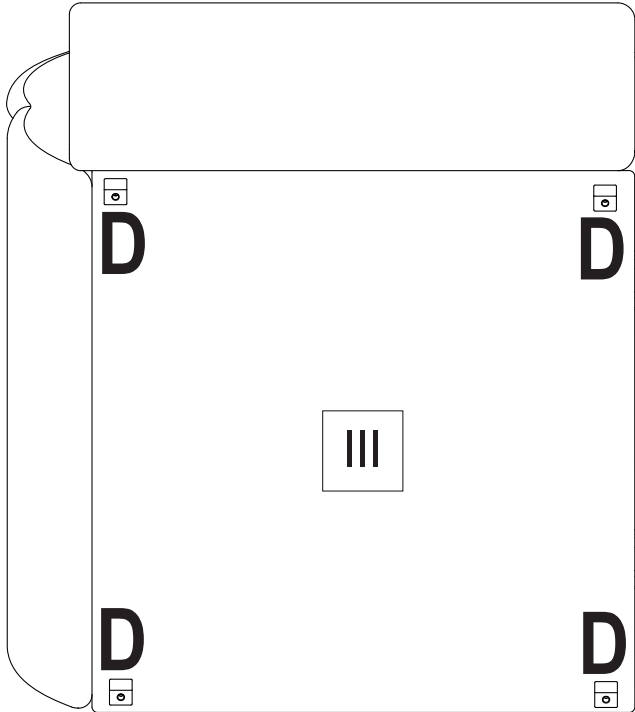

10

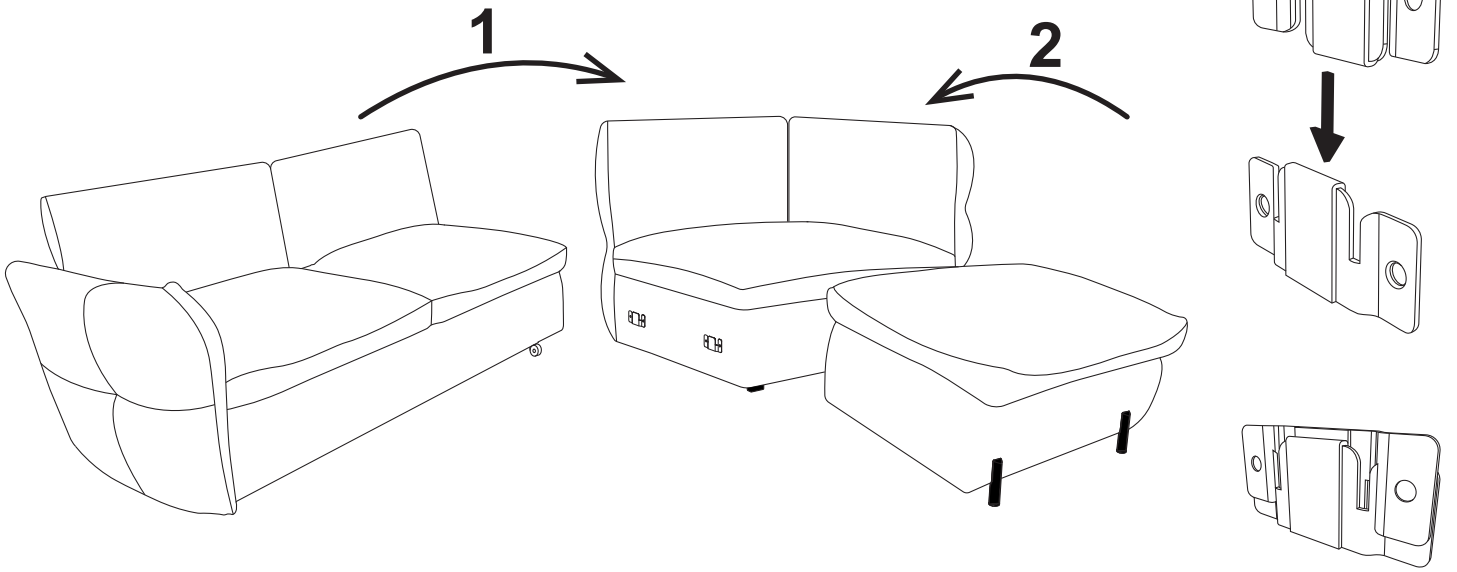

11

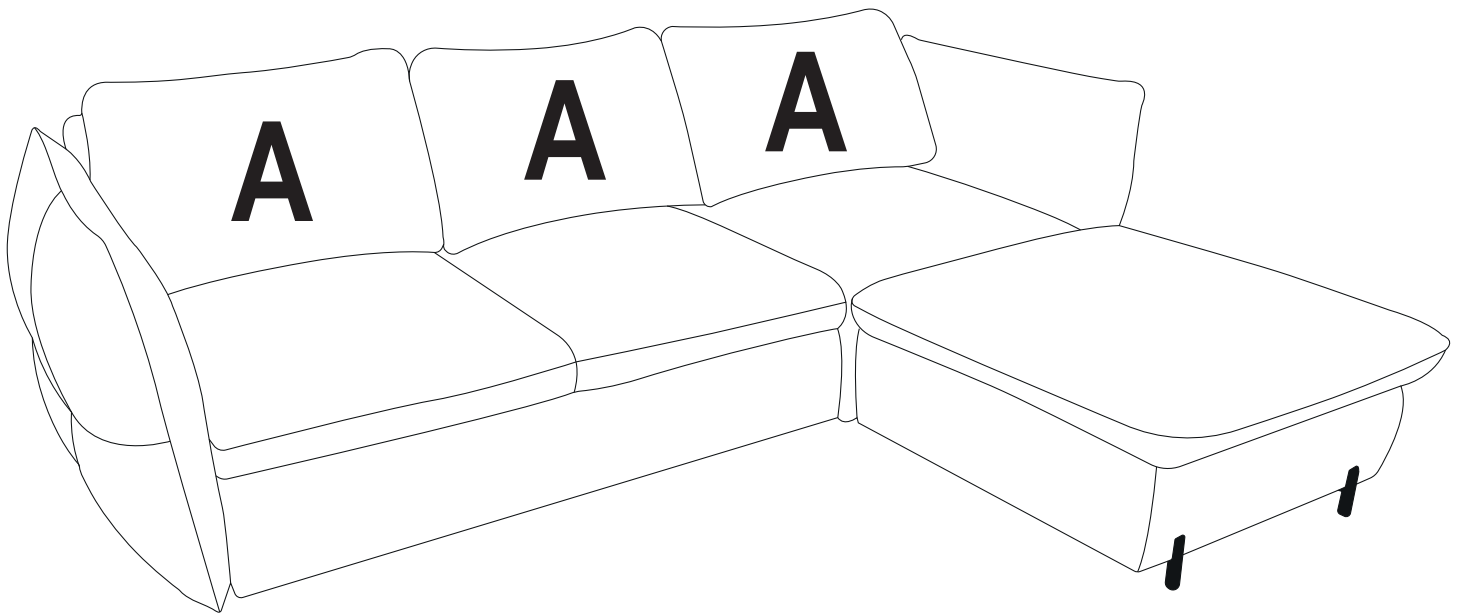

12

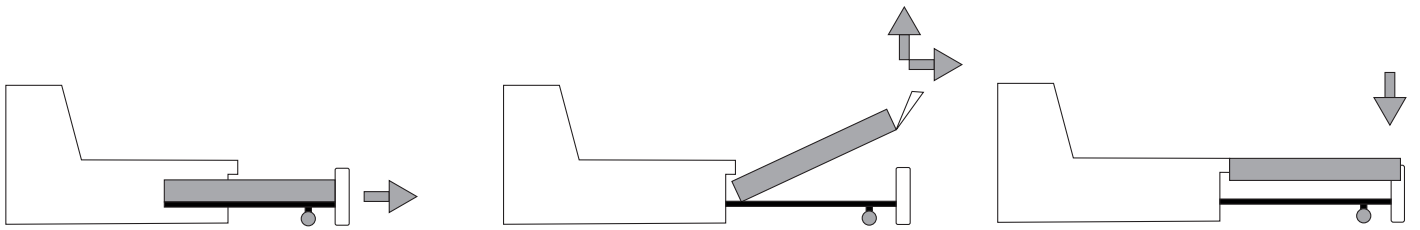
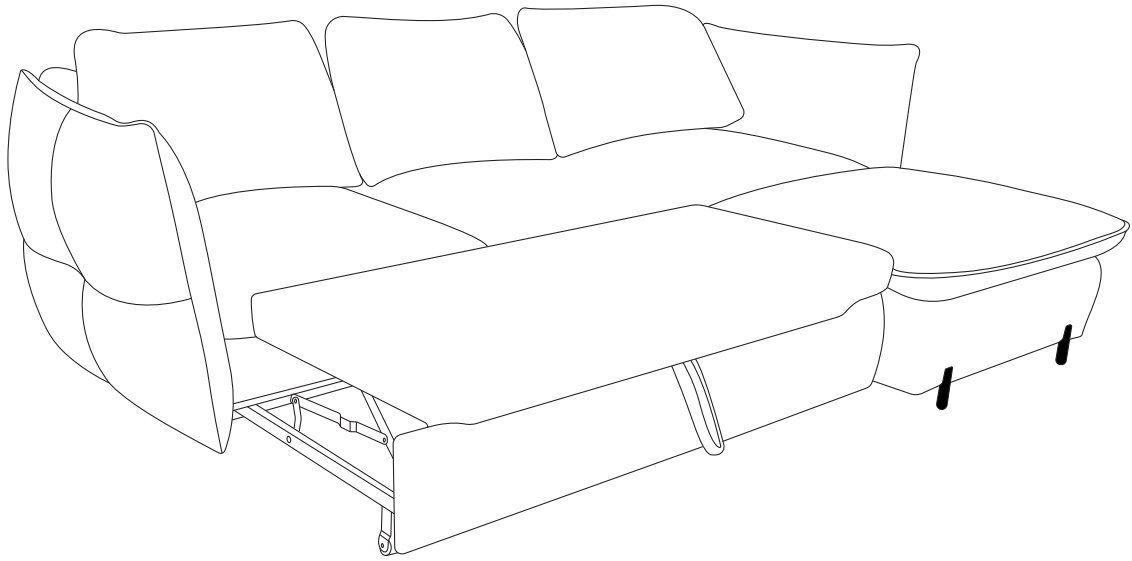

13

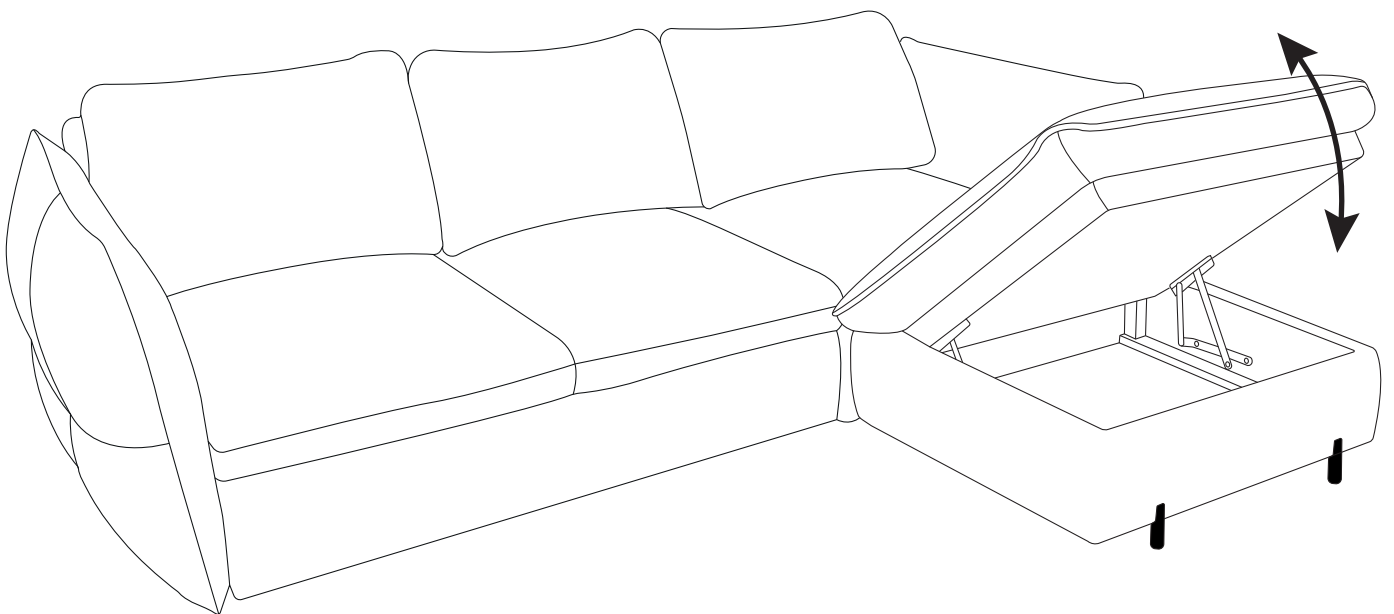

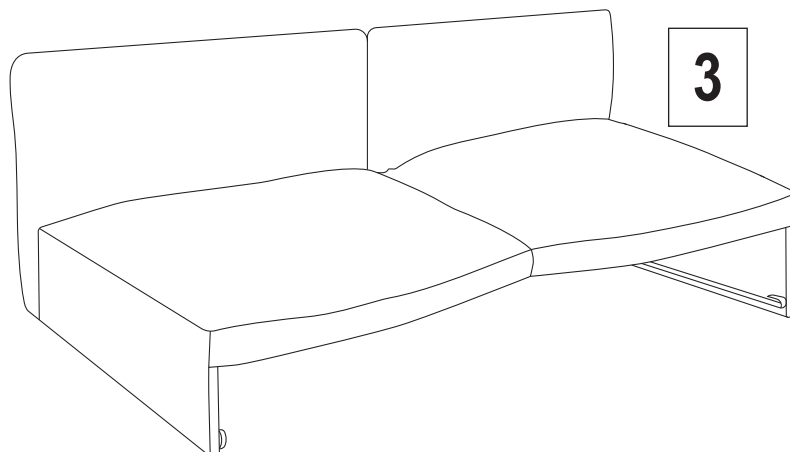
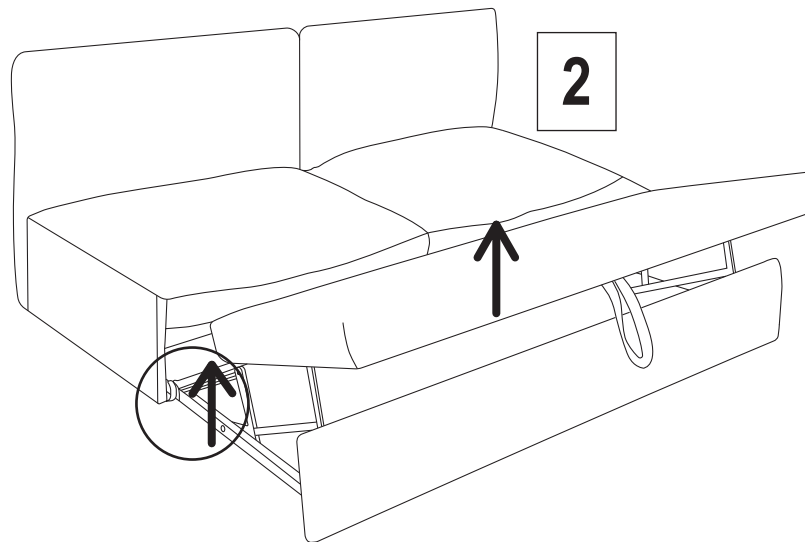
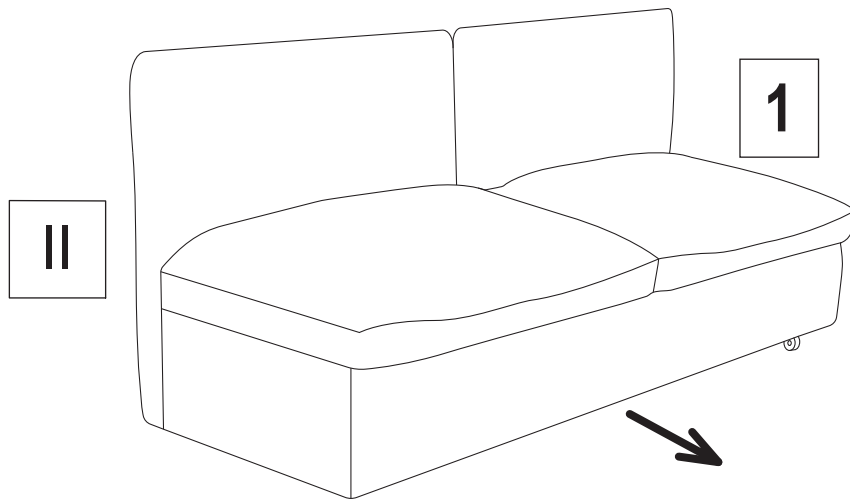

15

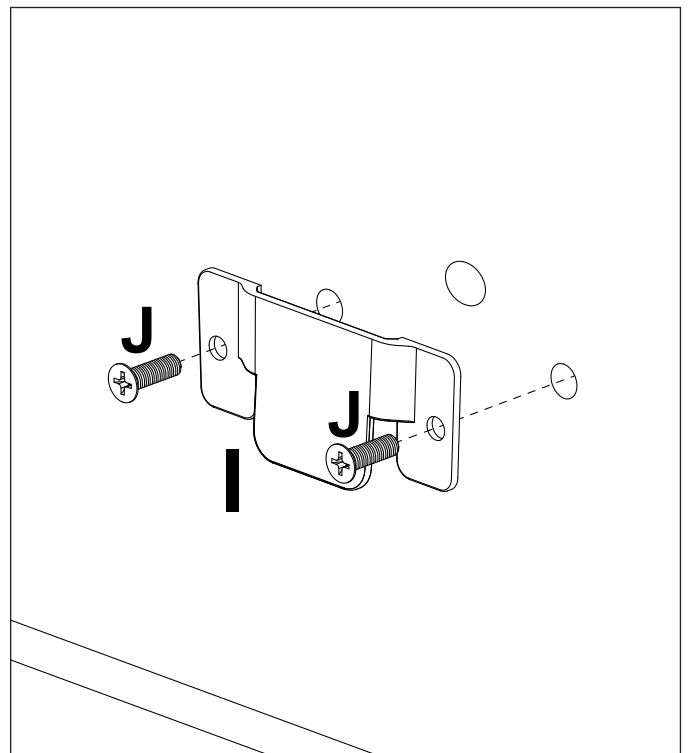
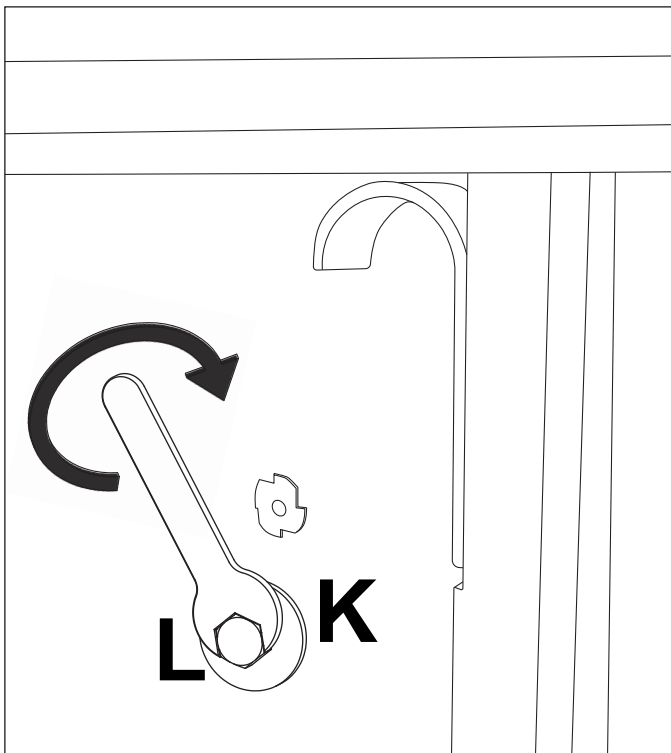
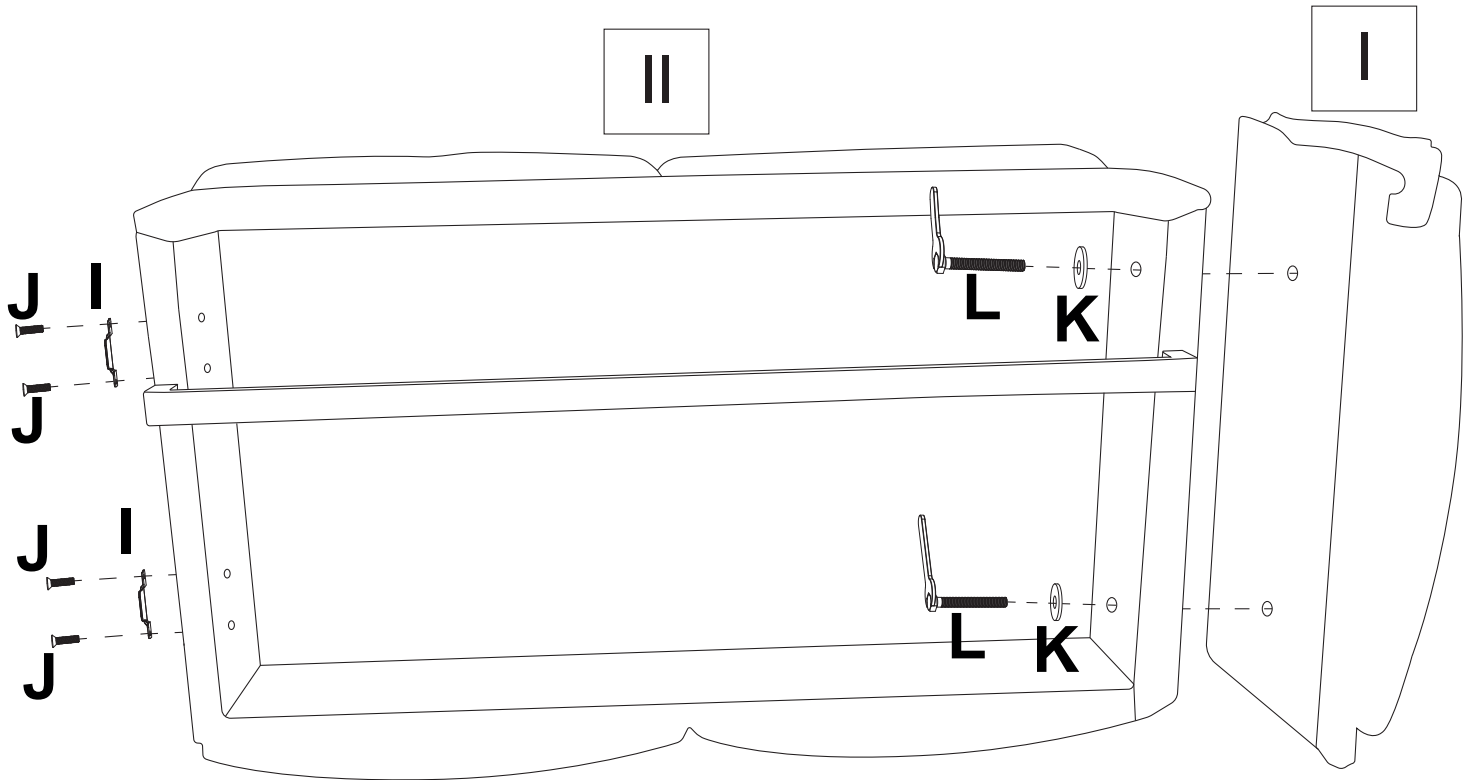
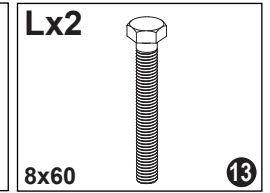
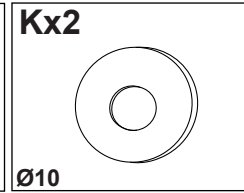
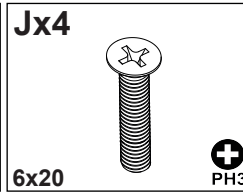
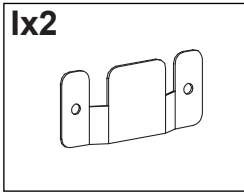

16

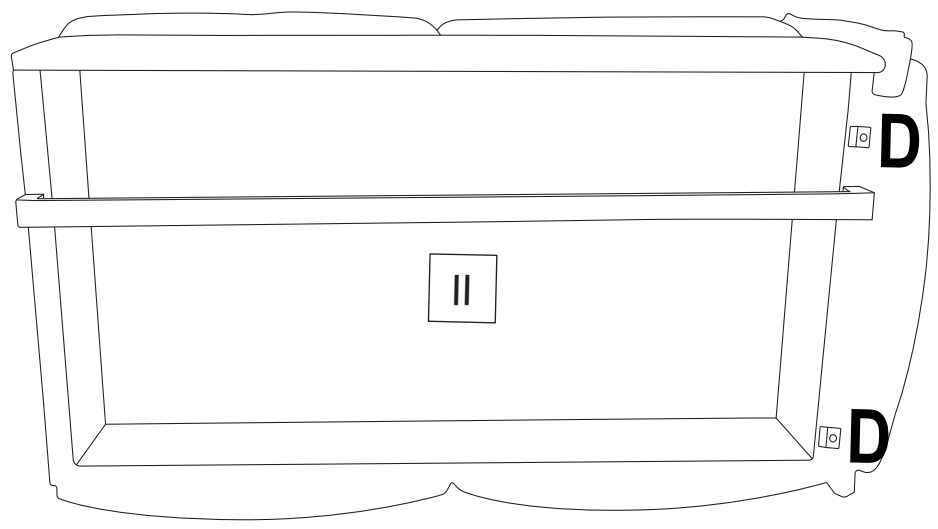
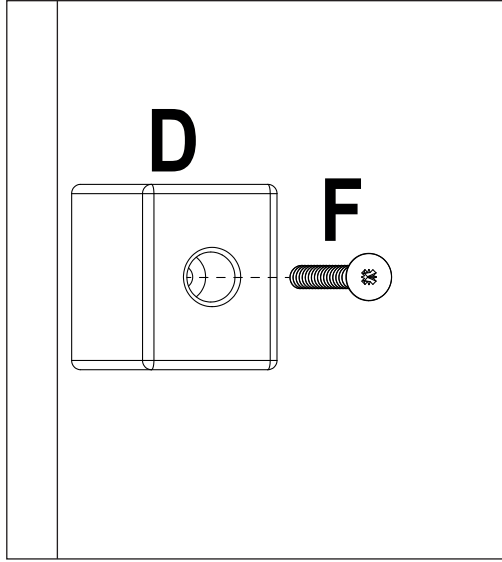
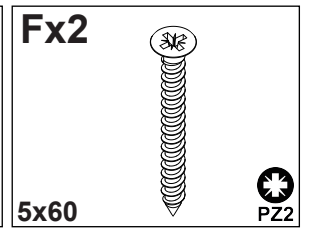
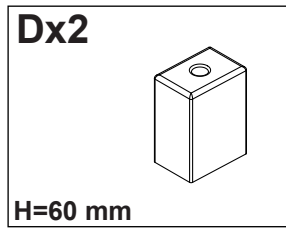

17

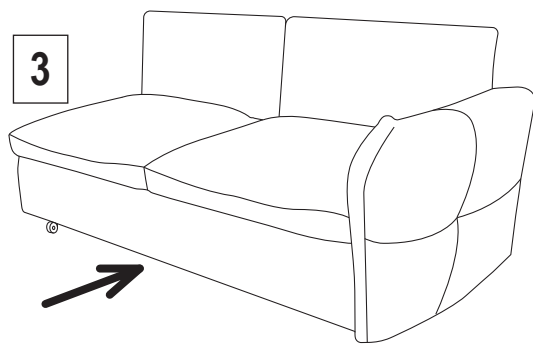
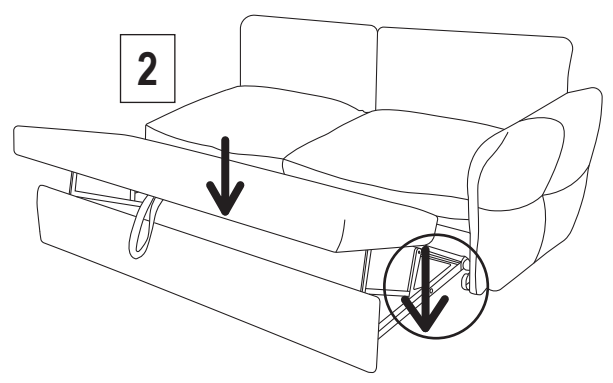
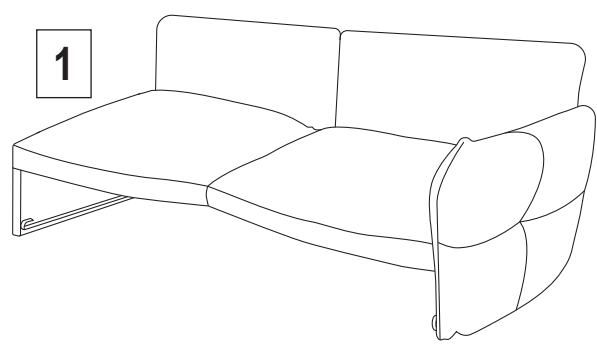

18

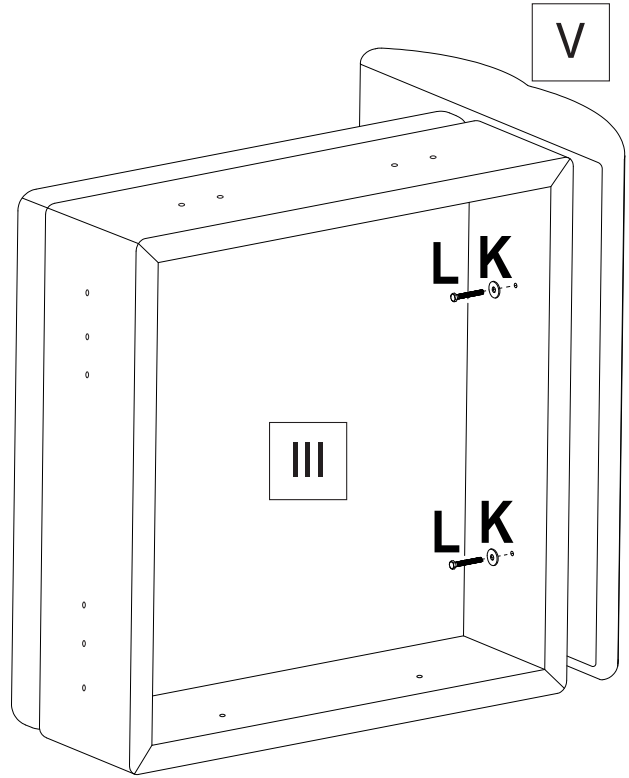
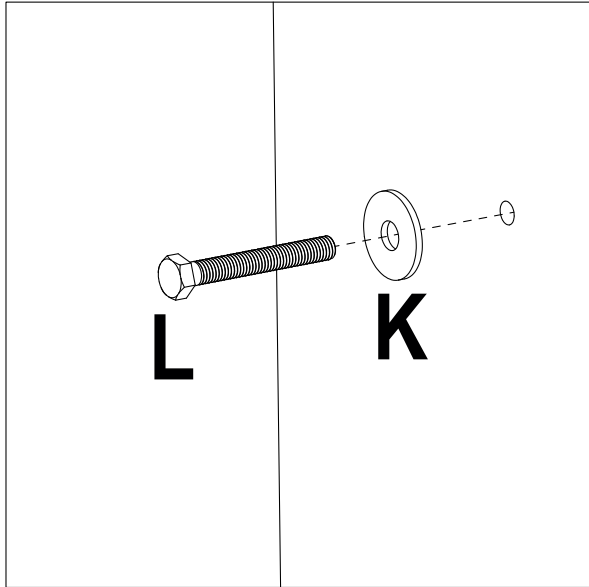
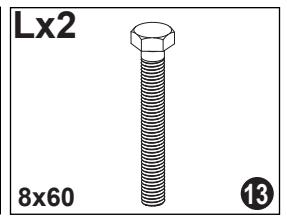
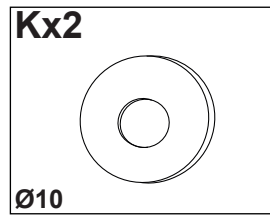
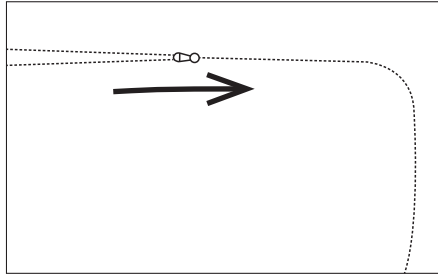

19

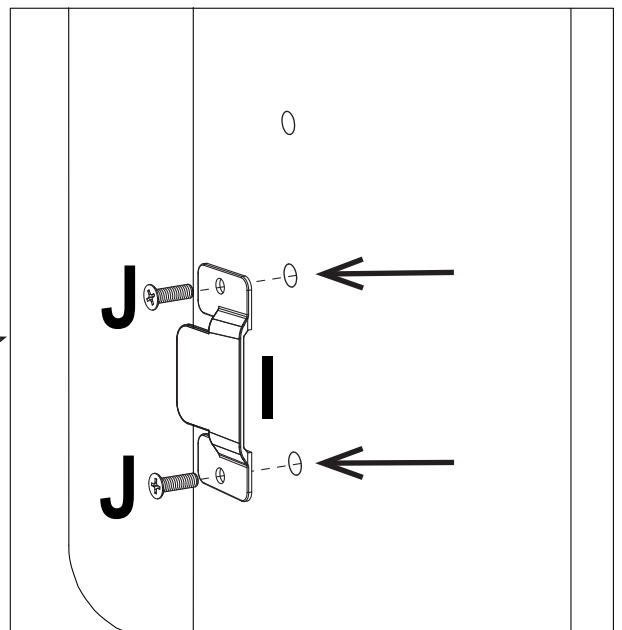
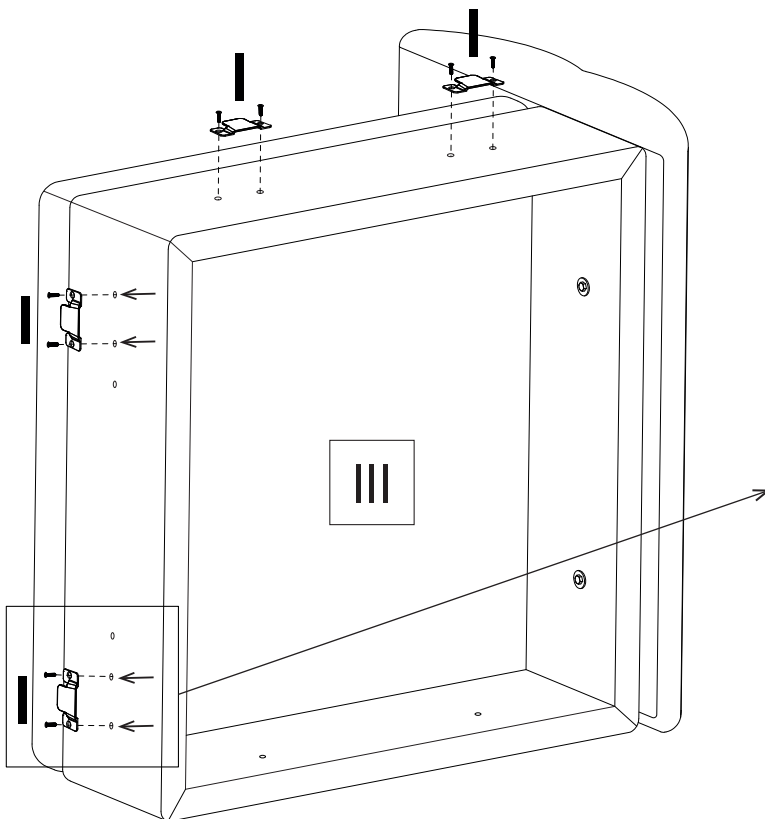
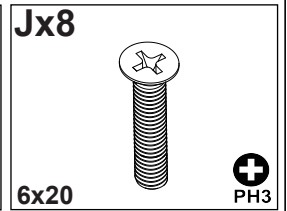
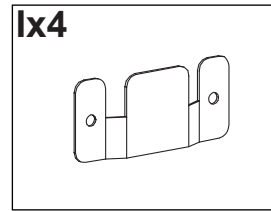

20

Kx2

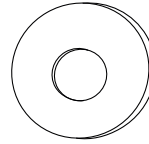

Ø10

Lx2

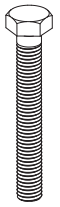

8x60

13

I

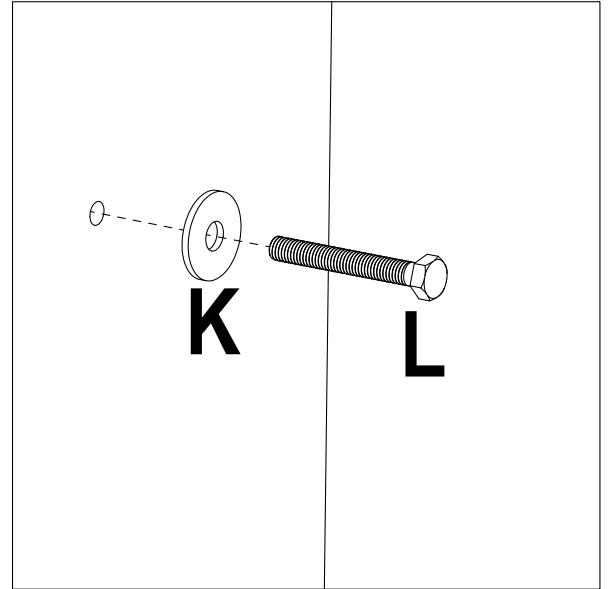
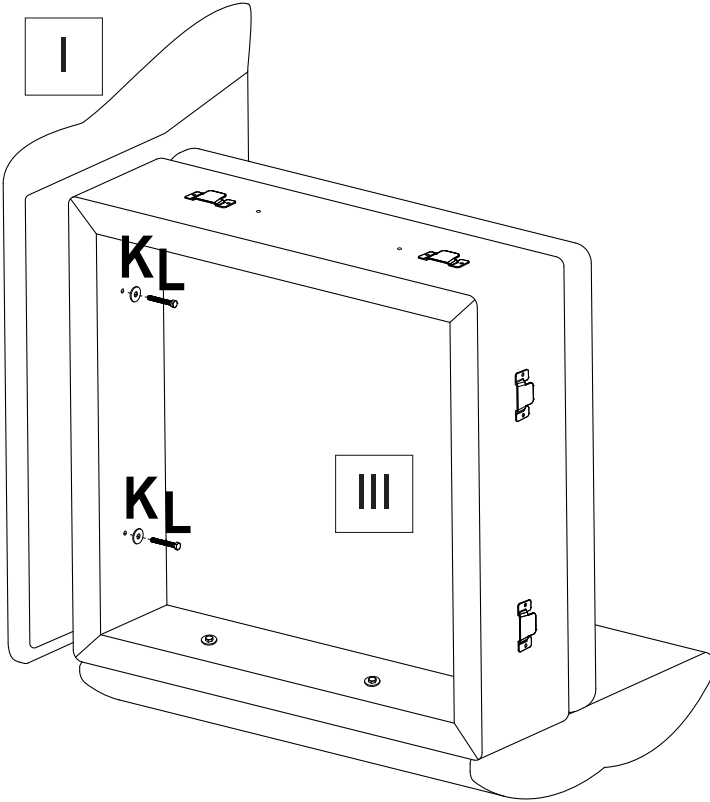

21

Ix2

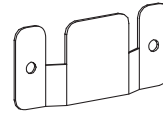

Jx4

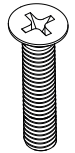

6x20

PH3

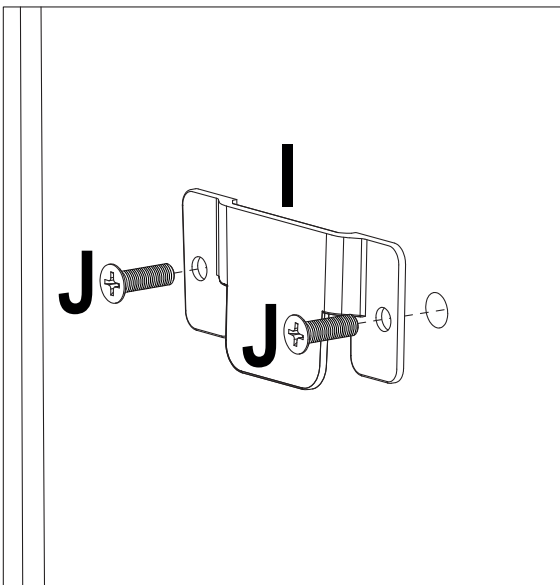

IV

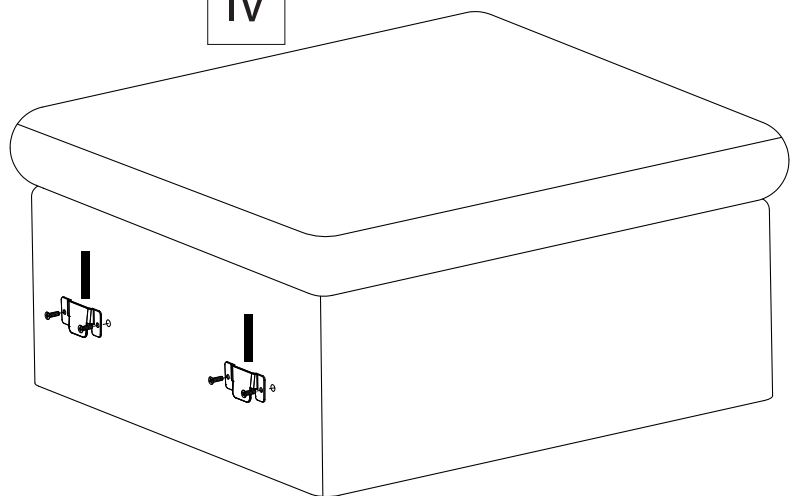

22

Cx2

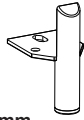

H=60/113 mm

Dx4

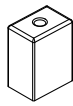

H=60 mm

Ex4



5x25



PZ2

Fx4



5x60



PZ2

Gx2



6x35



PH3

Hx2

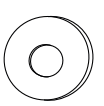

Ø6

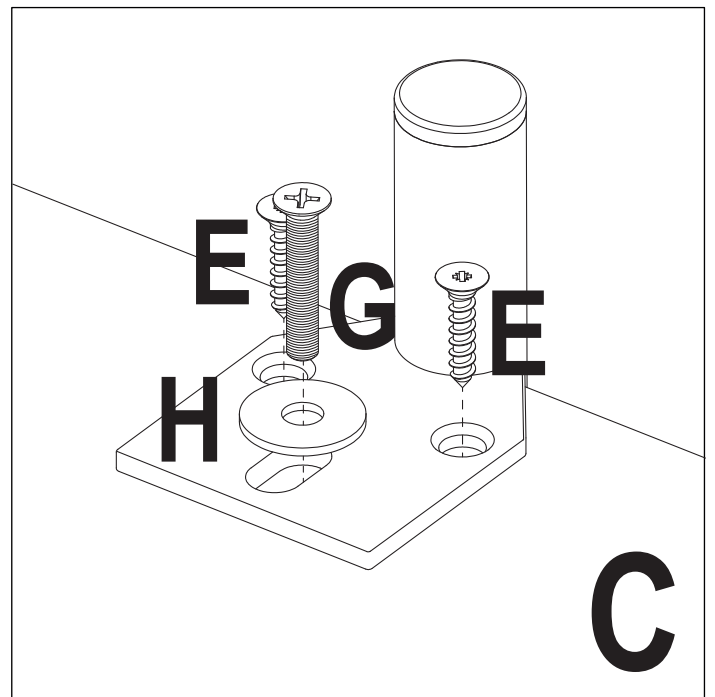
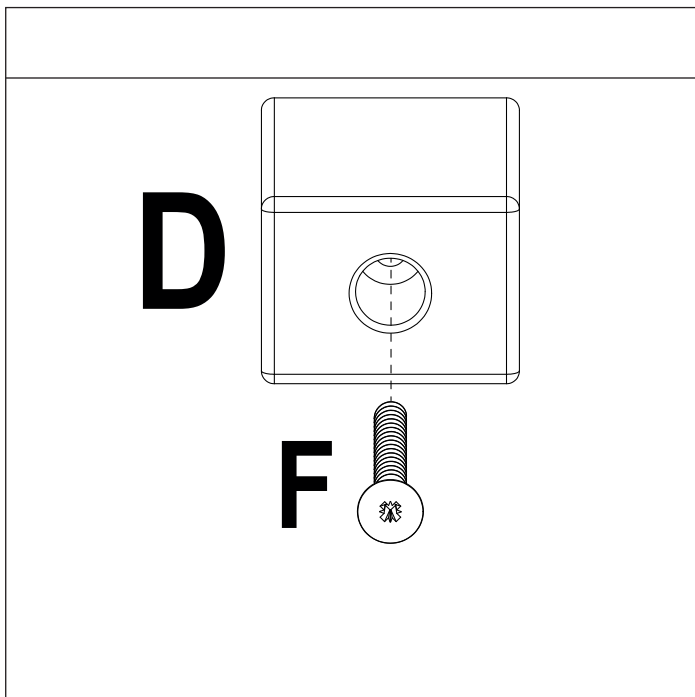
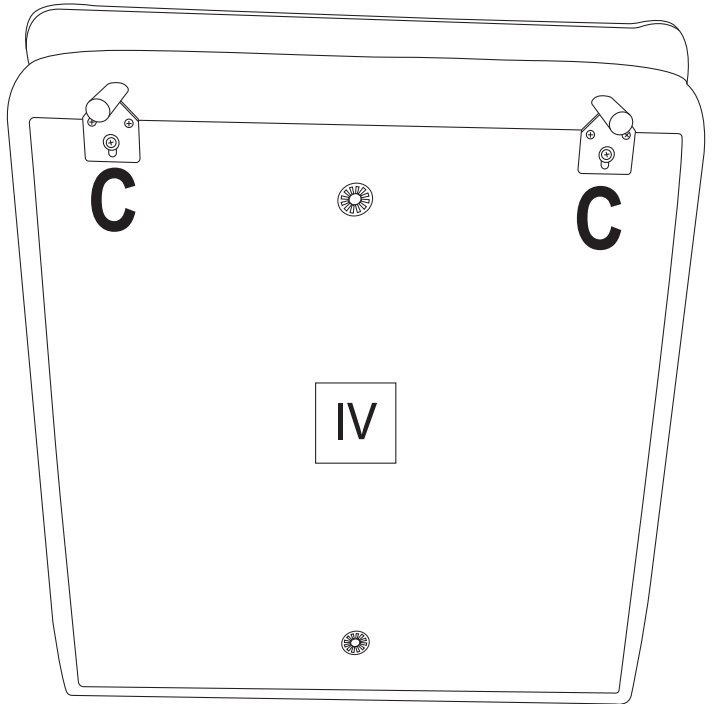
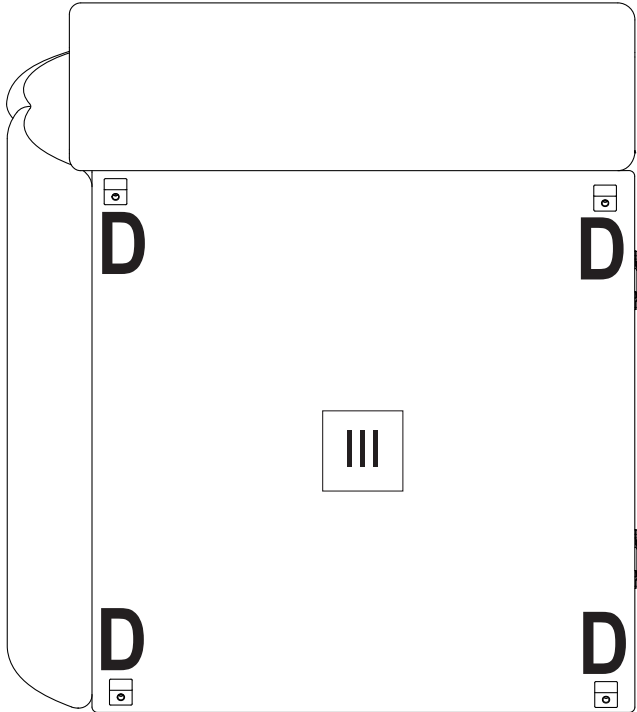

23

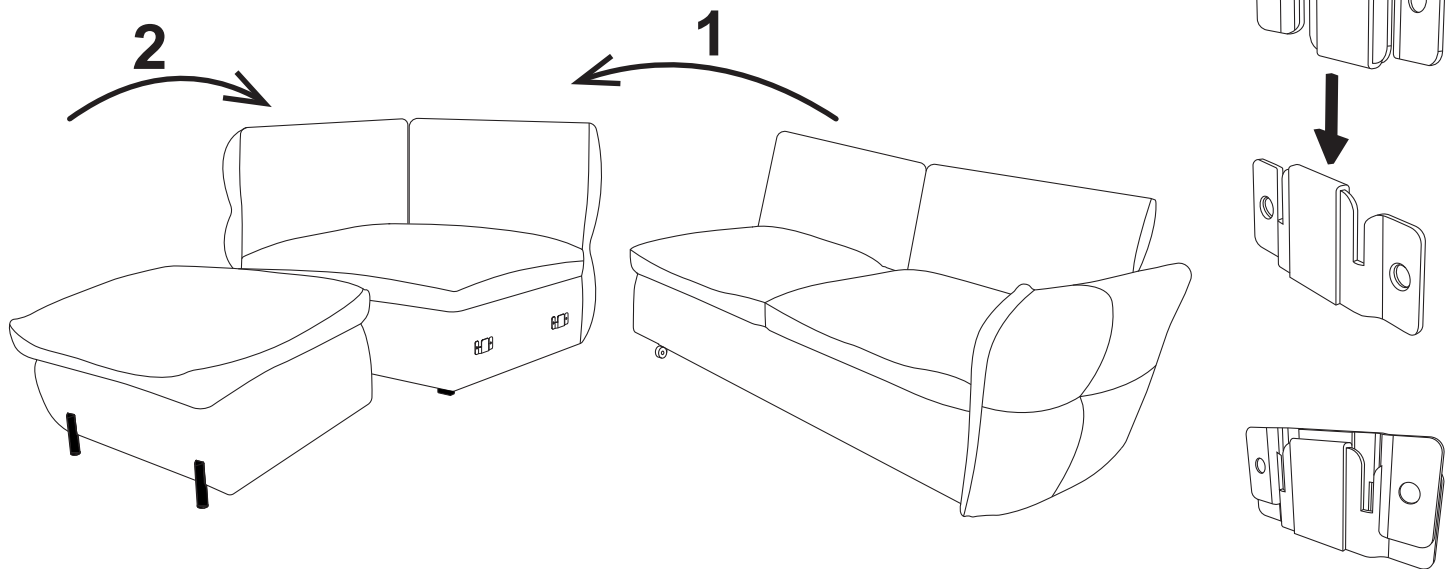

24

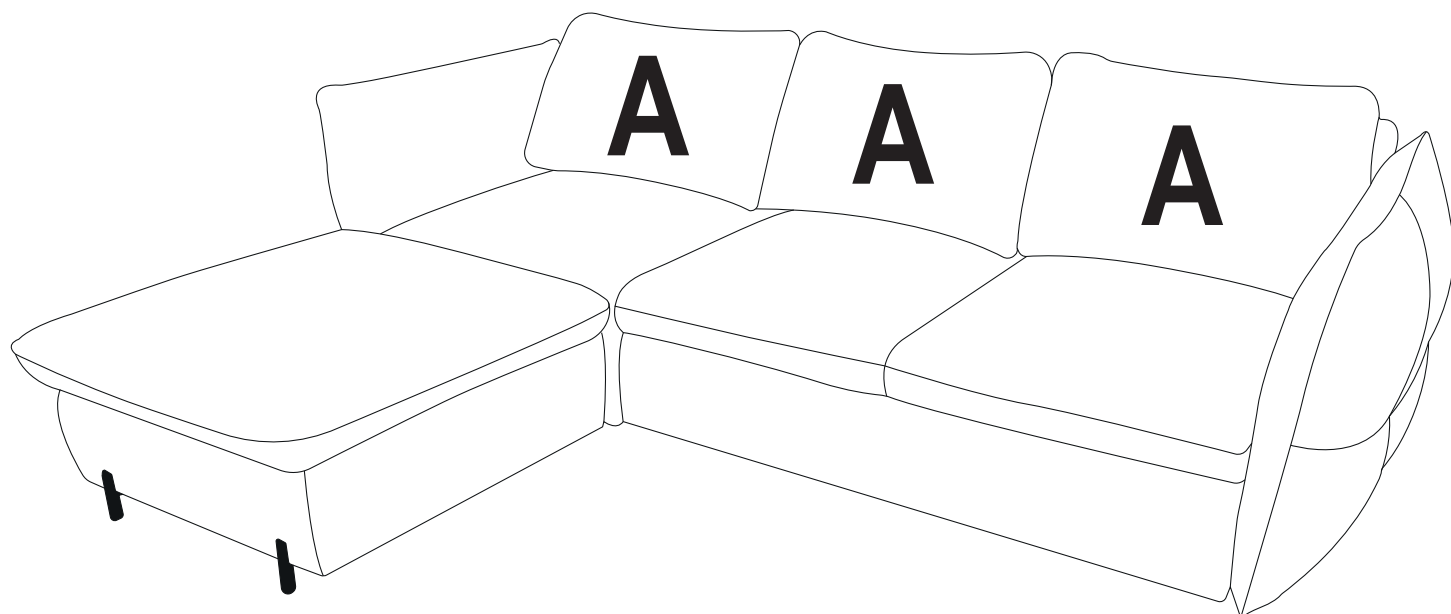

25

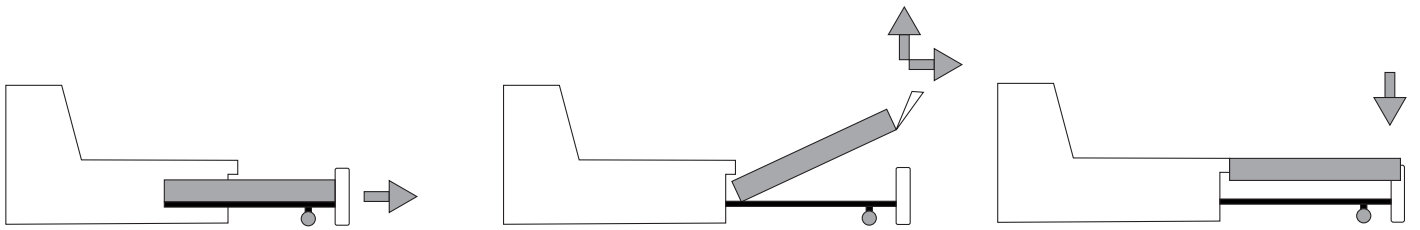
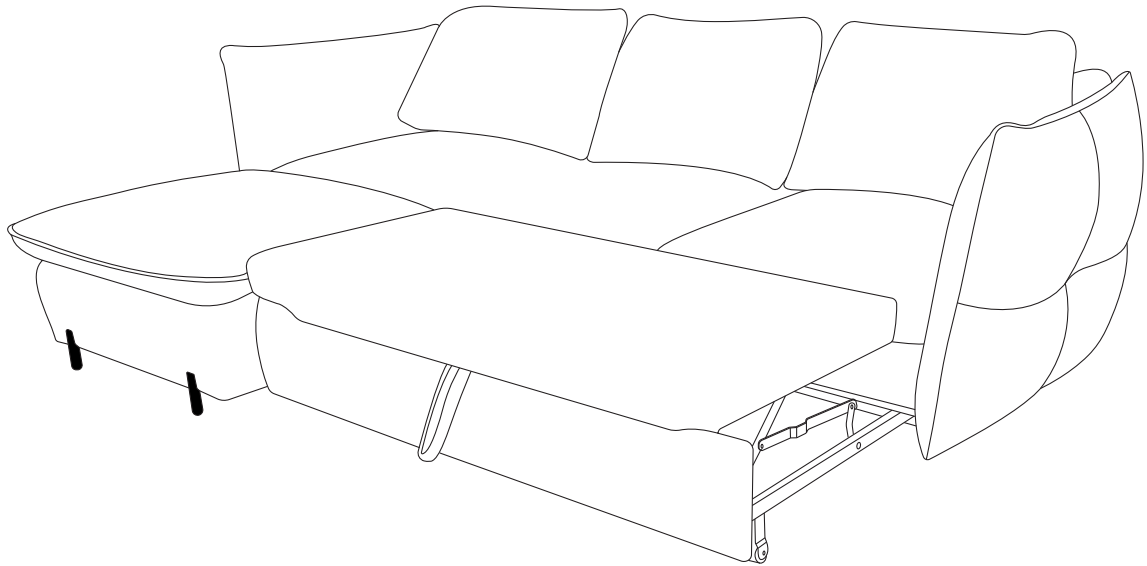

26

