

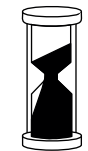

JUDY / JULIA

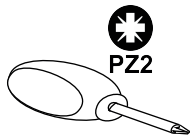

30min

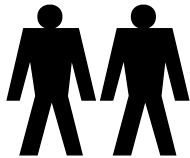

PZ2

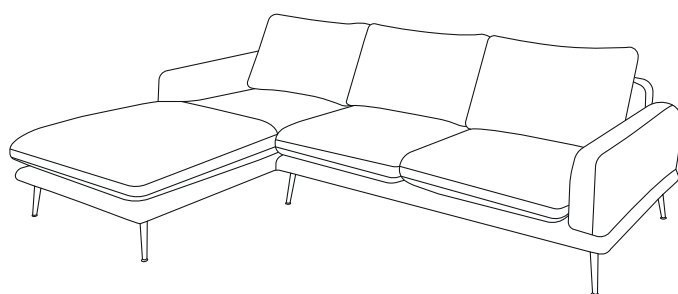
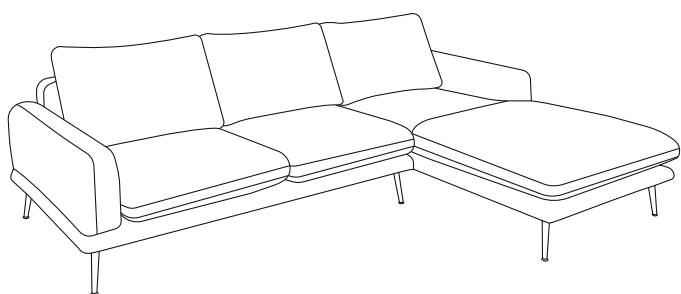

I

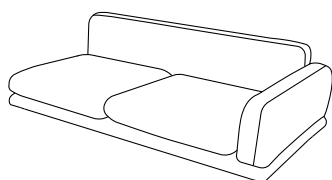
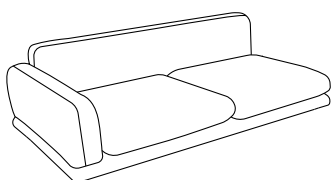

II

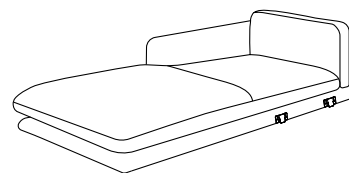
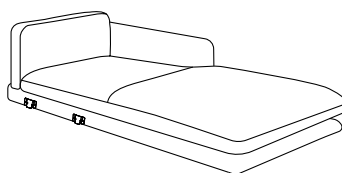

Ax3

Bx7

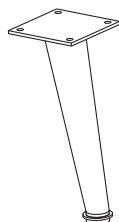

H=200 mm

Cx2



H=145-230 mm

Dx28

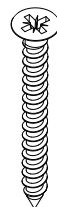

5x40



PZ2

1

Bx4

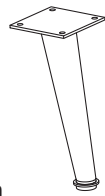

H=200 mm

Cx1

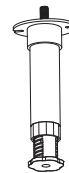

H=145-230 mm

Dx16



5x40



PZ2

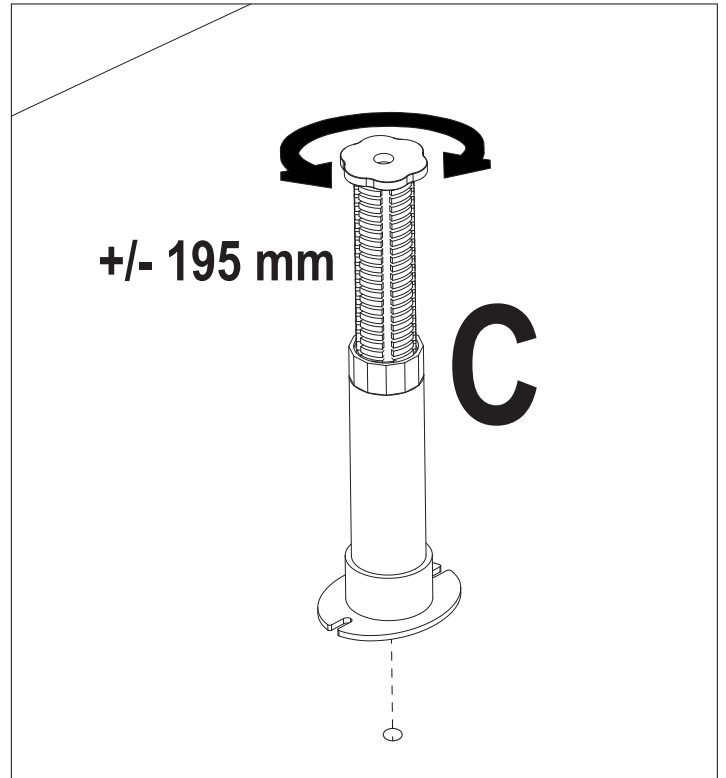
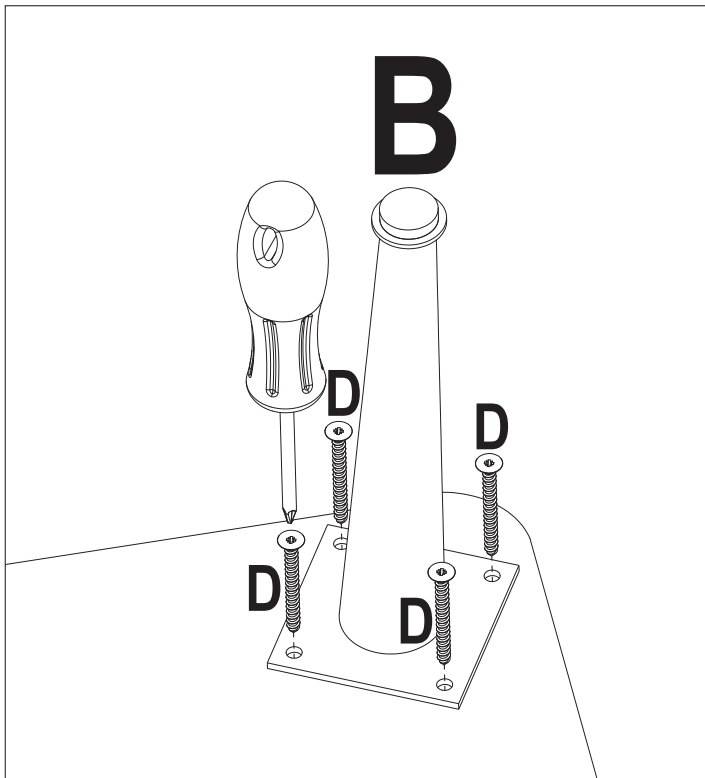
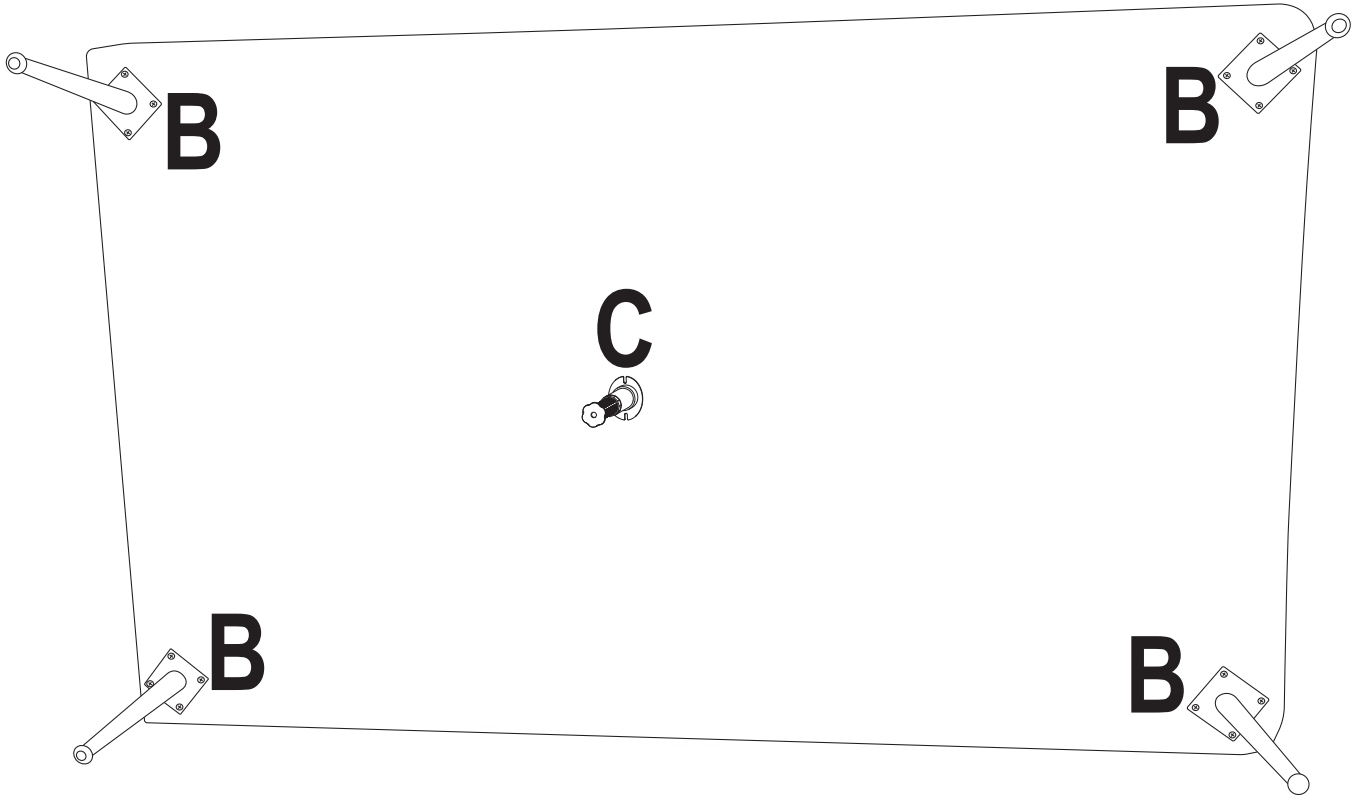

2

Bx3



H=200 mm

Cx1

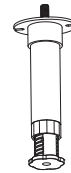

H=145-230 mm

Dx12

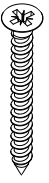

5x40



PZ2

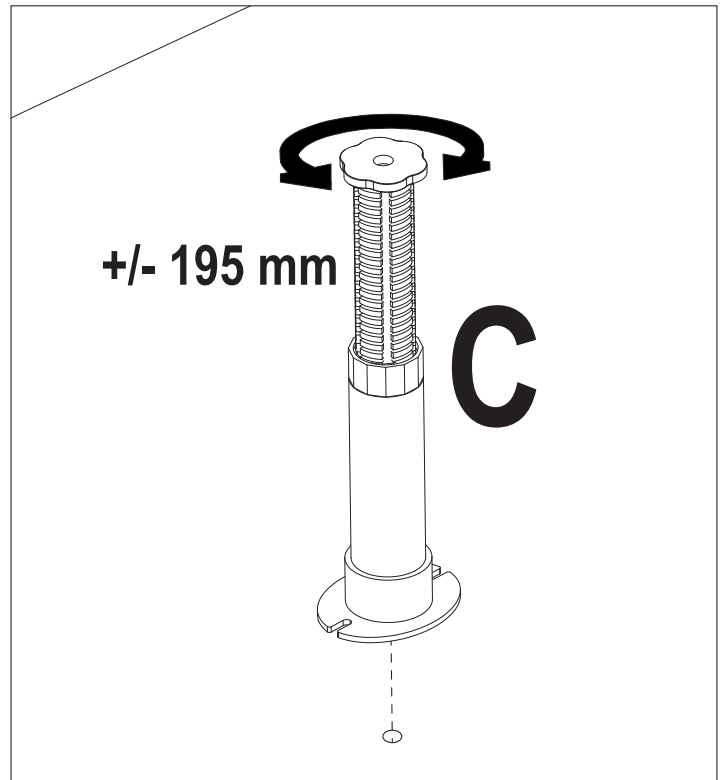
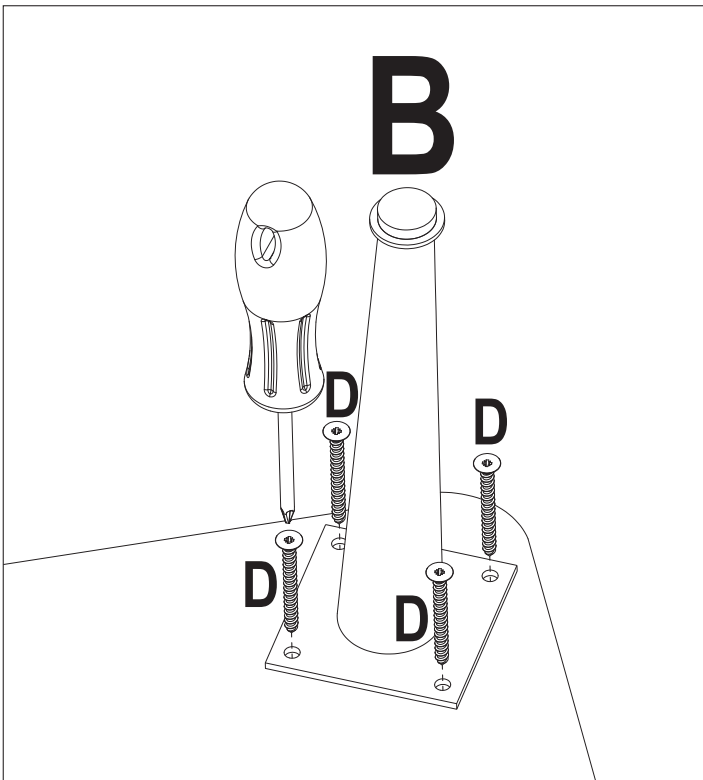
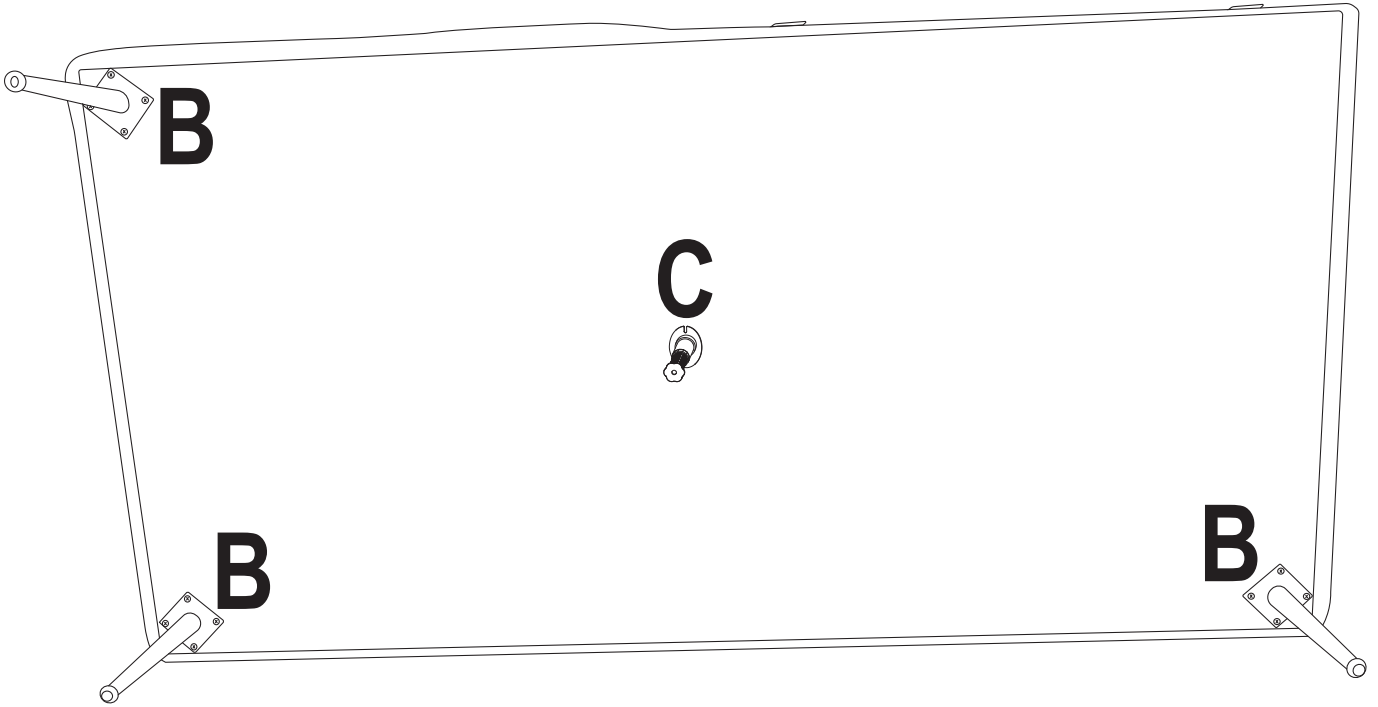

3

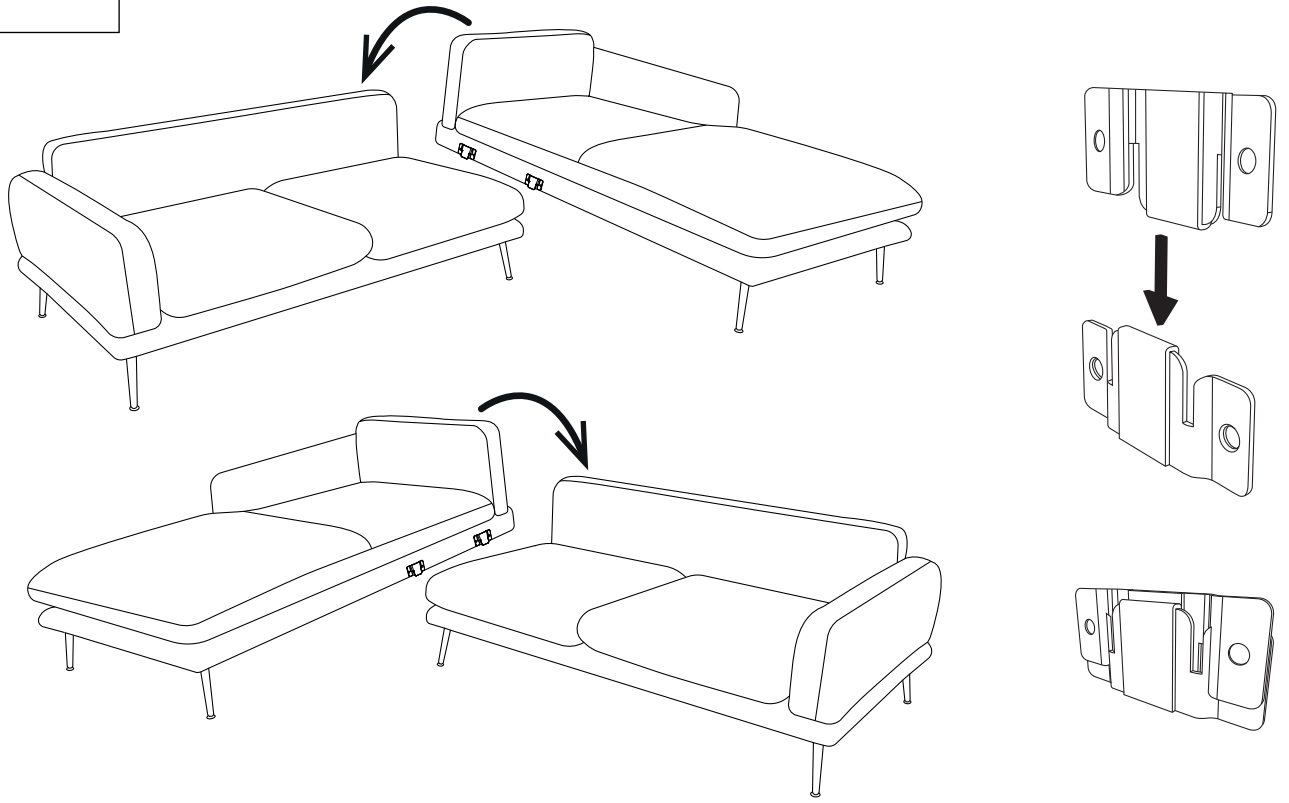

4

