

MARIO / LARA

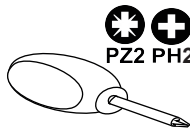

30min

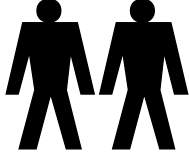

PZ2 PH2 PH3

R

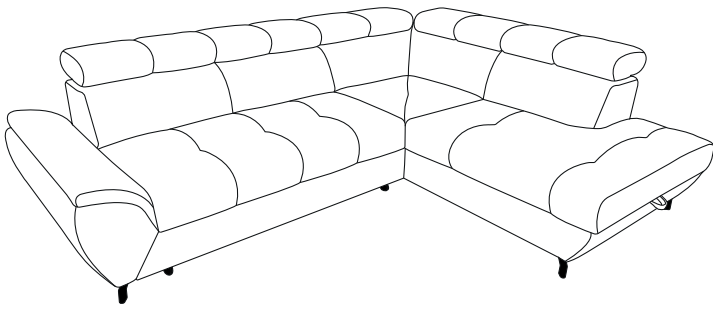

L

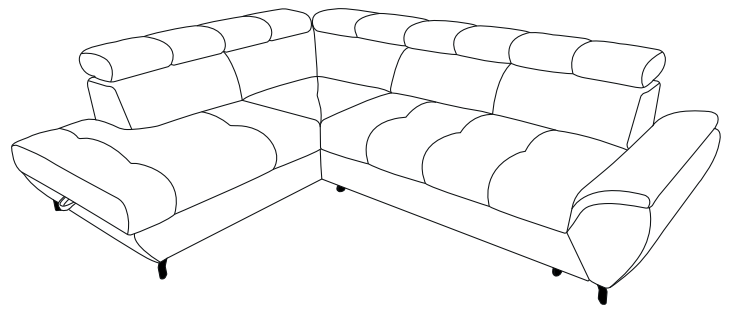

I

R L

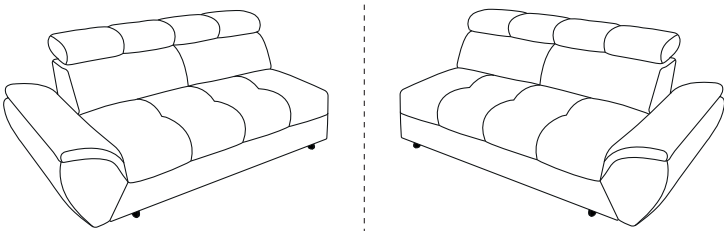

II

R L

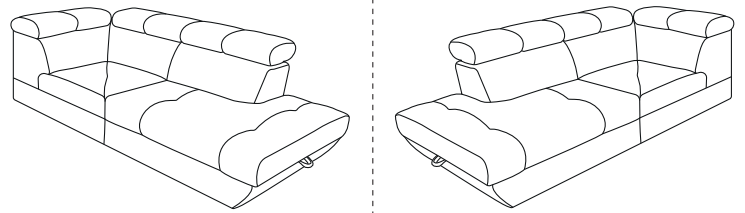

Ax4

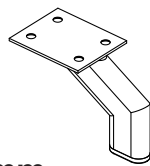

H=87 mm

Bx3

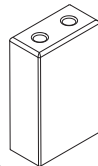

H=87 mm

Cx1

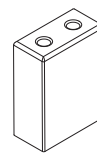

H=50 mm

Dx12

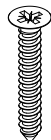

5x25



Ex4

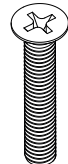

6x30



Fx6



5x80



Gx2

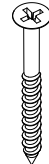

3,5x55



1

Ax2

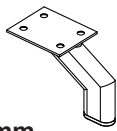

H=87 mm

Cx1

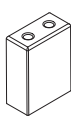

H=50 mm

Dx4



5x25



Ex4

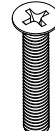

6x30

Gx2

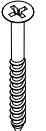

3,5x55



PH2

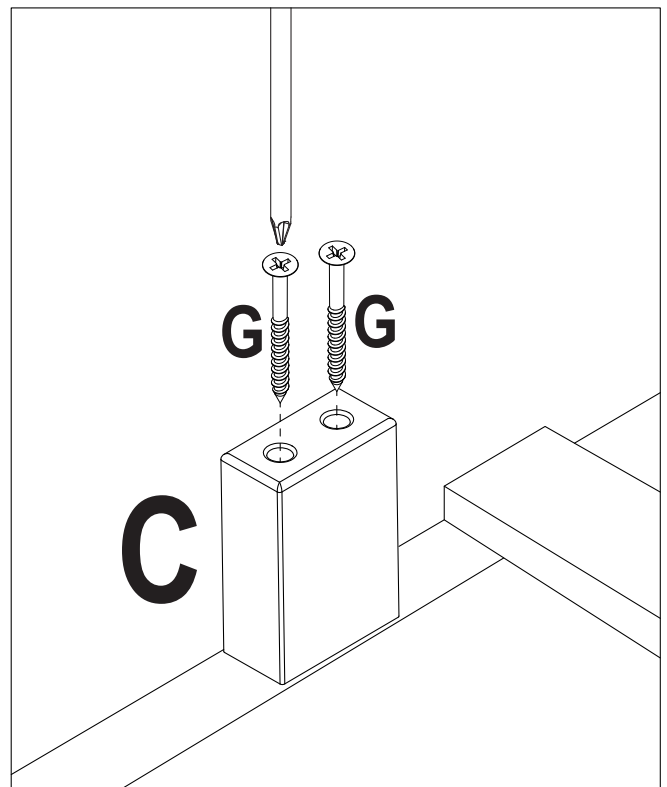
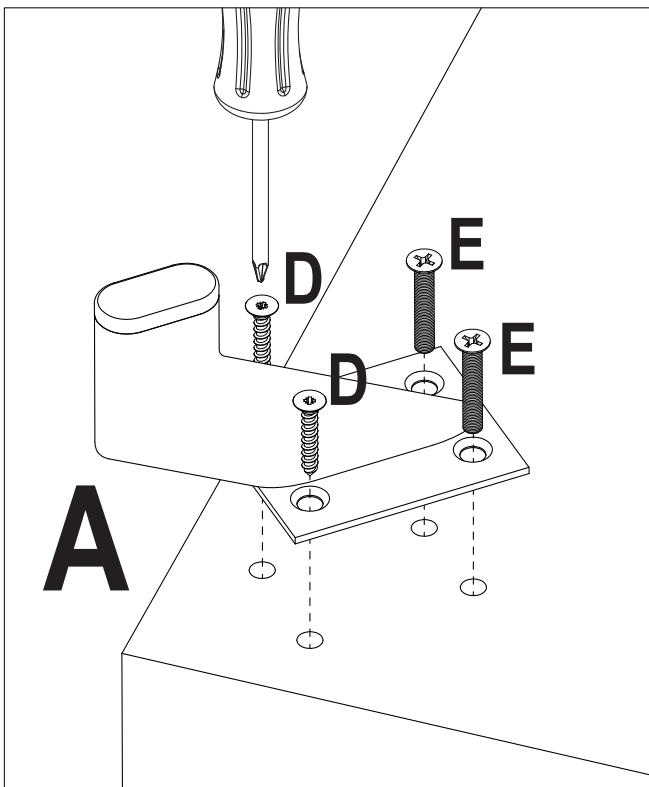
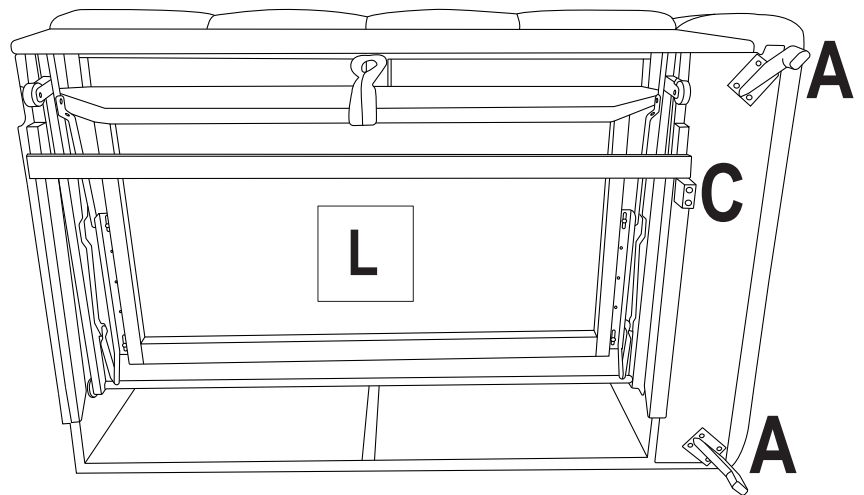
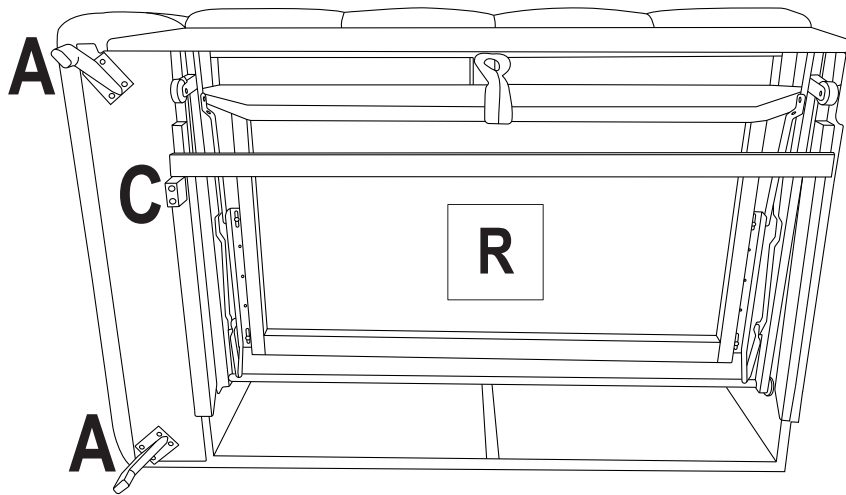

2

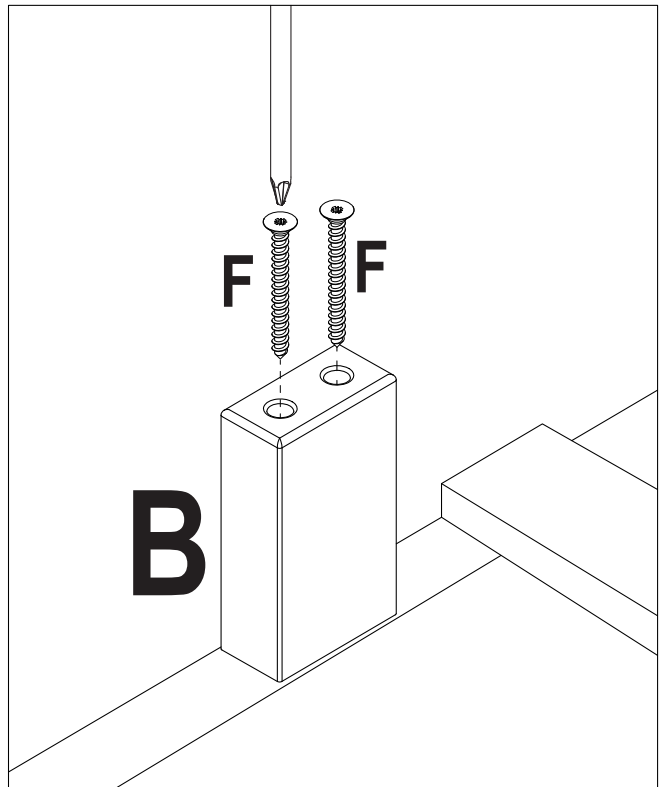
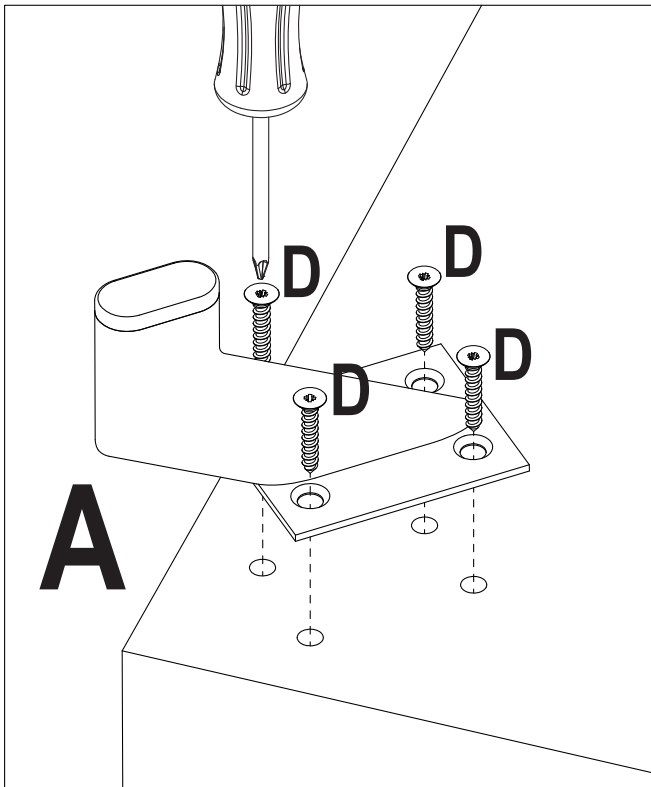
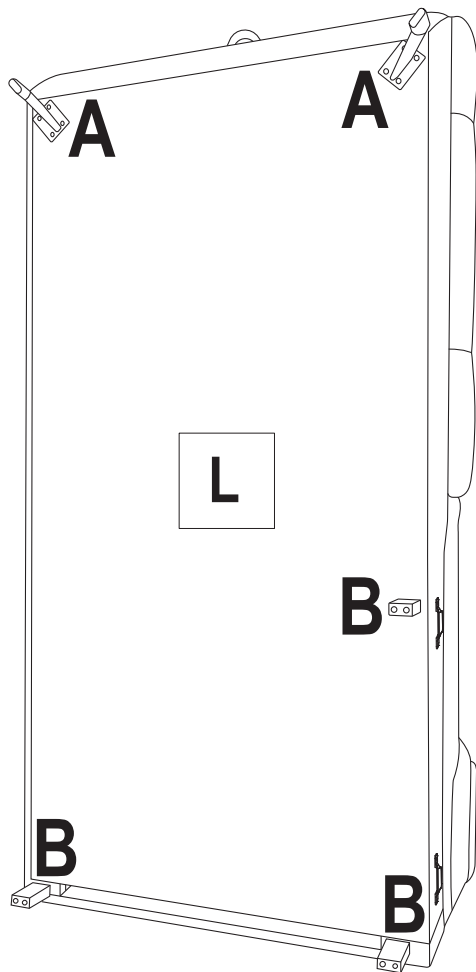
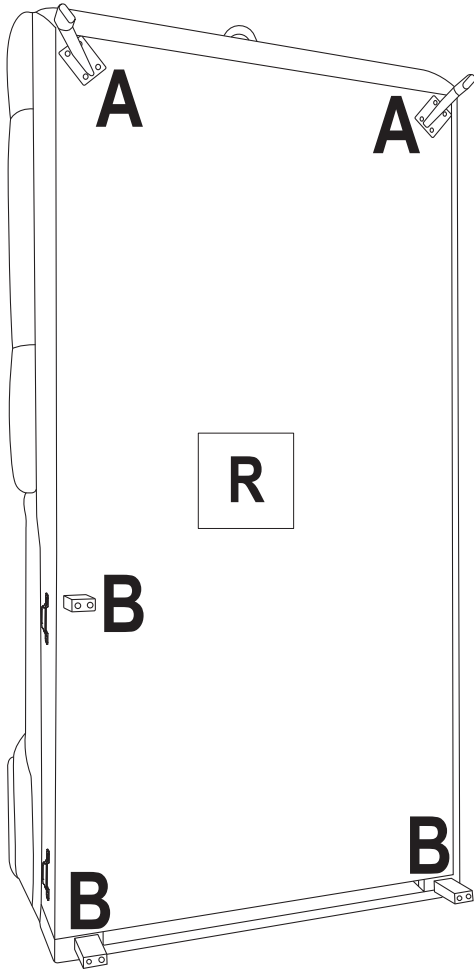
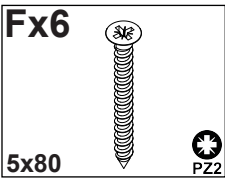
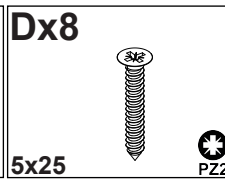
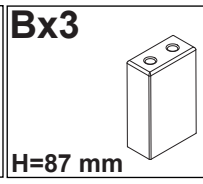
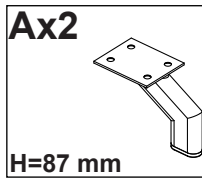

3

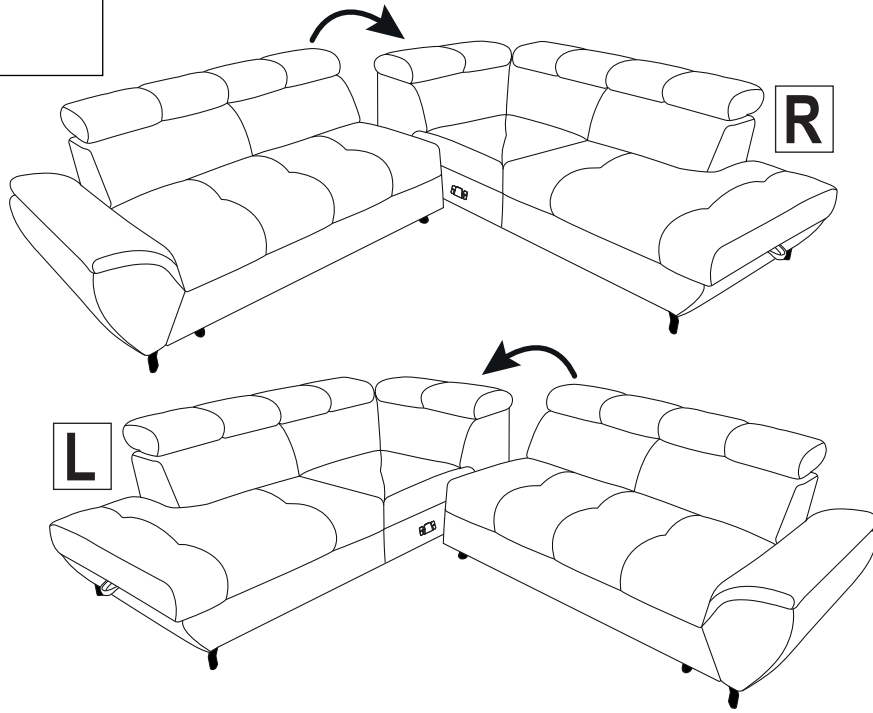

4

