

MATTIA

2.05.2024

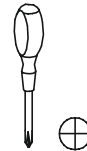
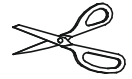
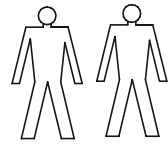

R-Prawy

L-Lewy

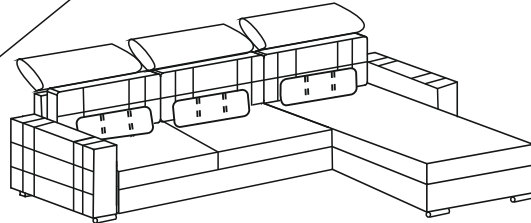
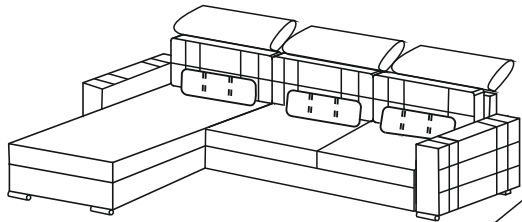

Ax1

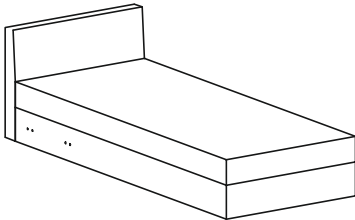

Bx1

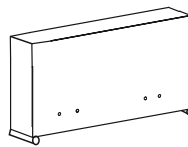

Cx1

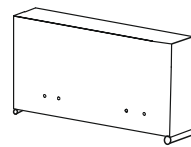

Dx1

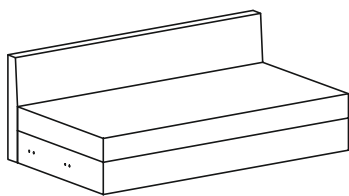

Ex3



F1 x 2

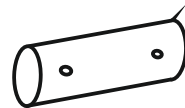

F2 x 3



Gx4

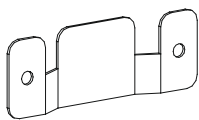

Hx8

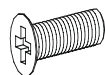

M6 x 16

I x 8

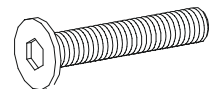

M6 x 50

Jx8

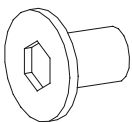

K1 x3



70mm

K2 x 4

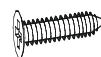

35mm

Lx1





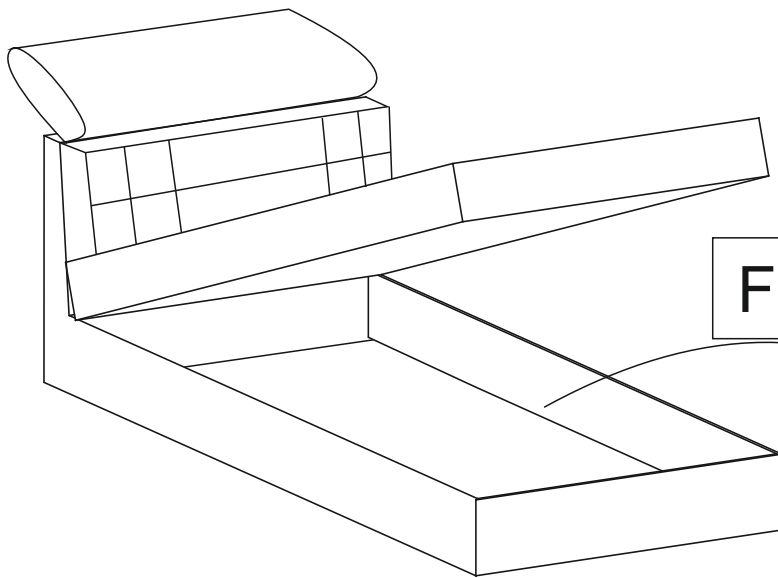

1

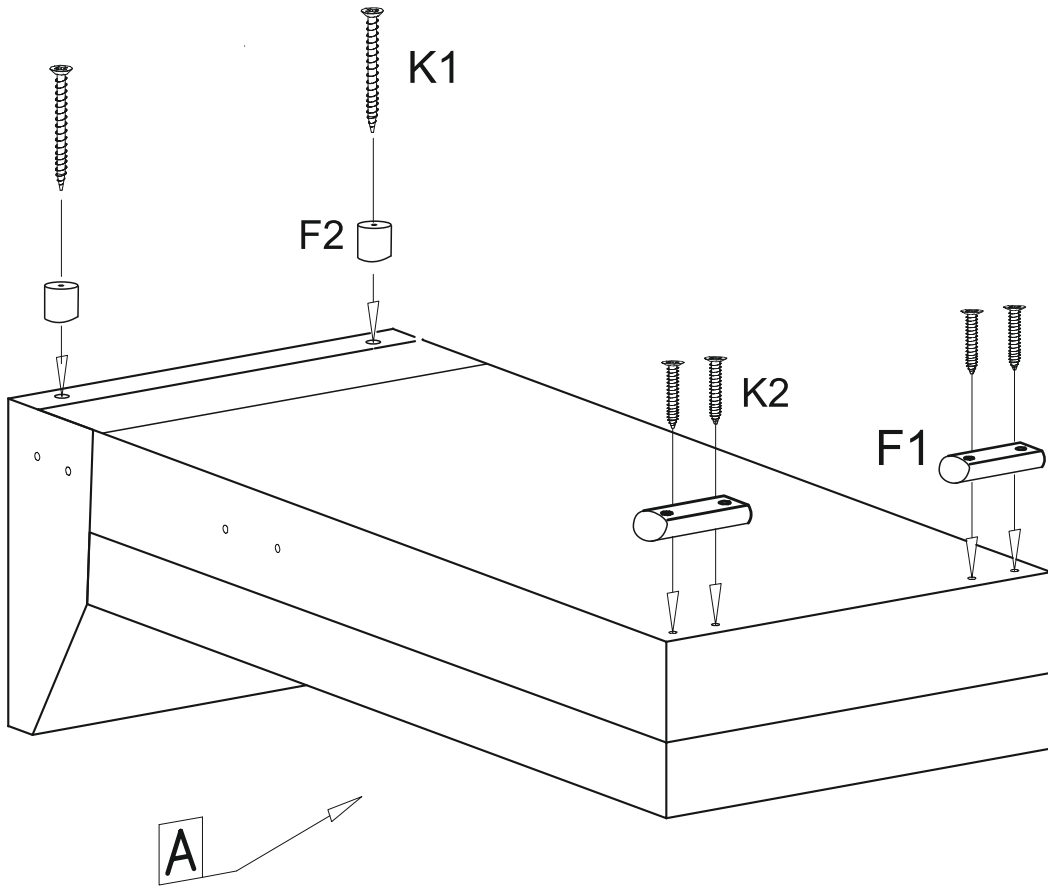

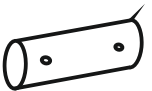
F+G+H+I+J+K+L

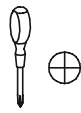

F1 x 2	K2 x 4	F2 x 4	K1 x 2	
				
	35mm		70mm	

2

2

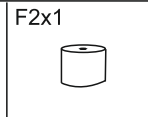
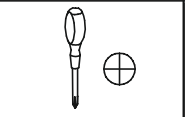
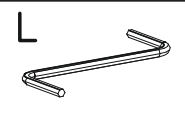
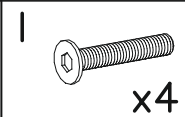
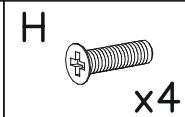
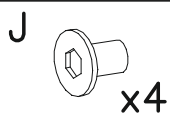
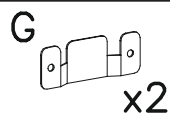
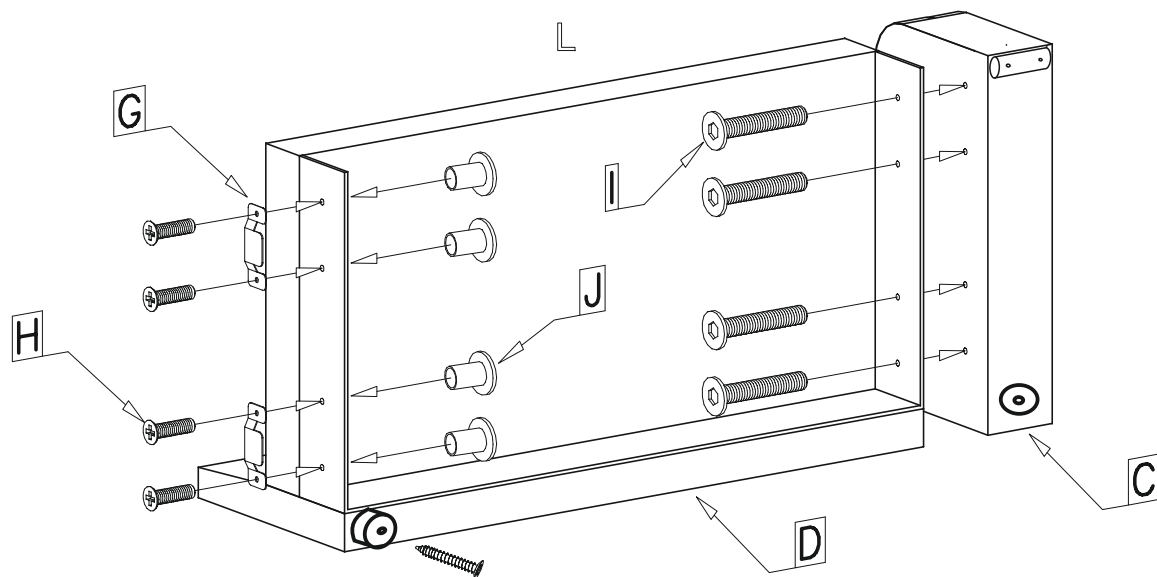

2

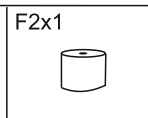
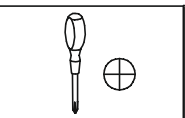
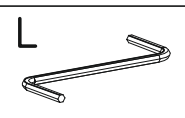
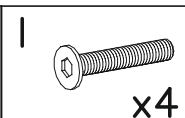
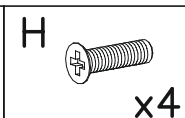
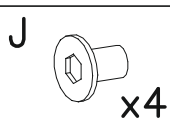
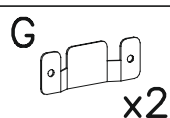
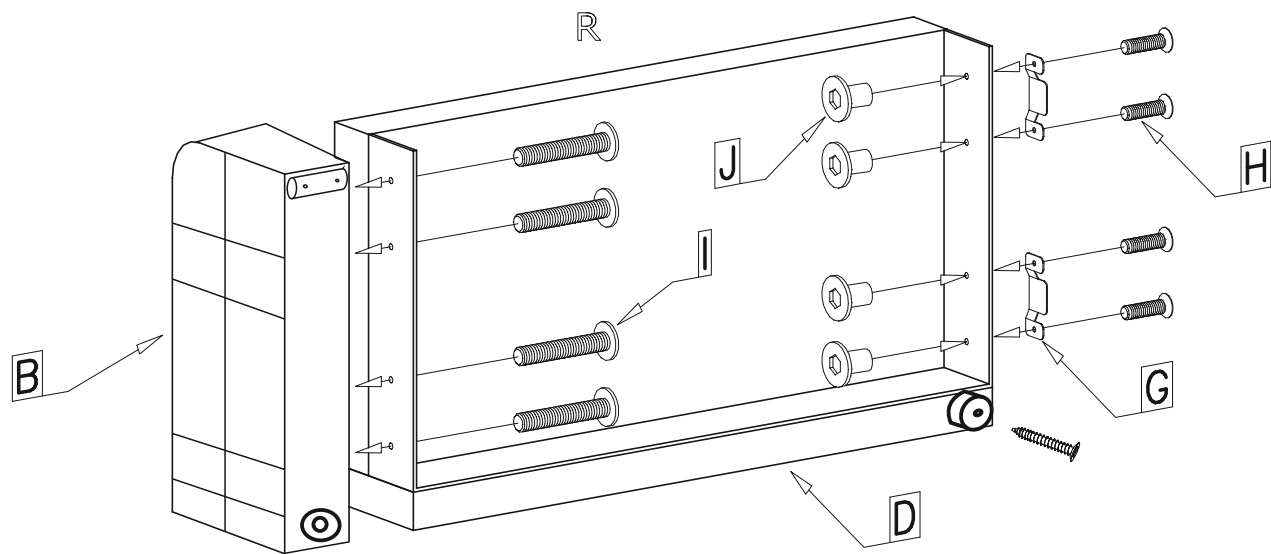



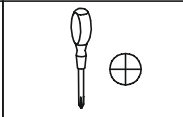
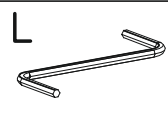
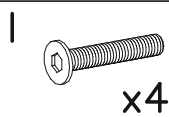
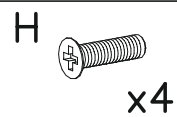
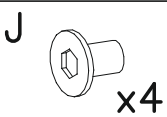
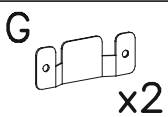
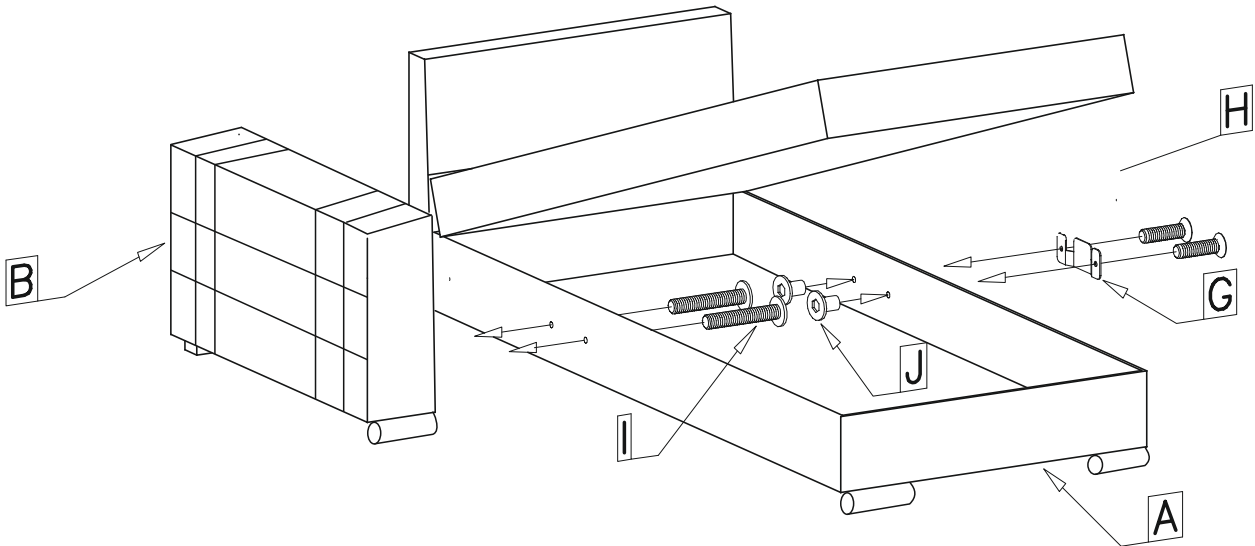
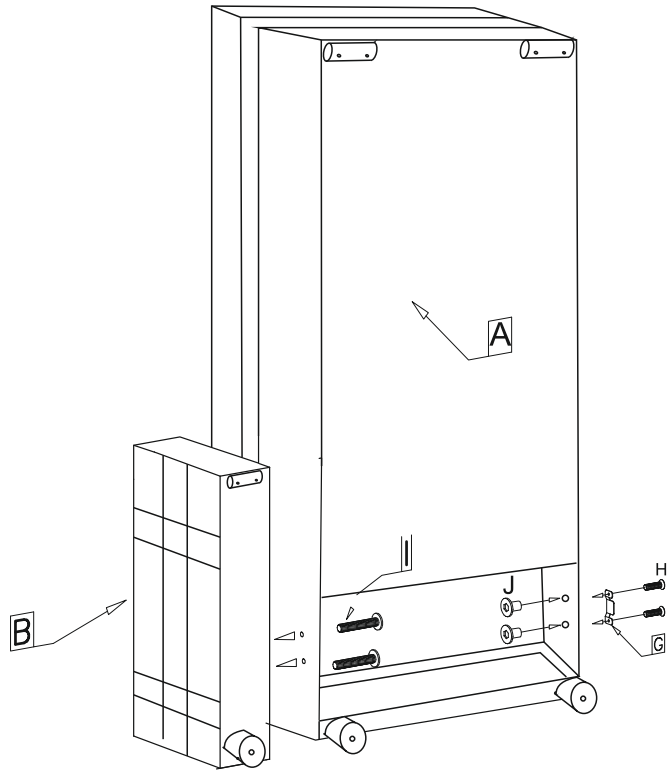
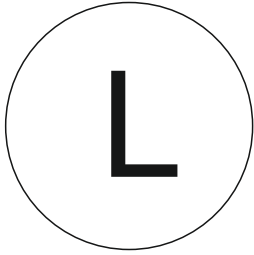

3

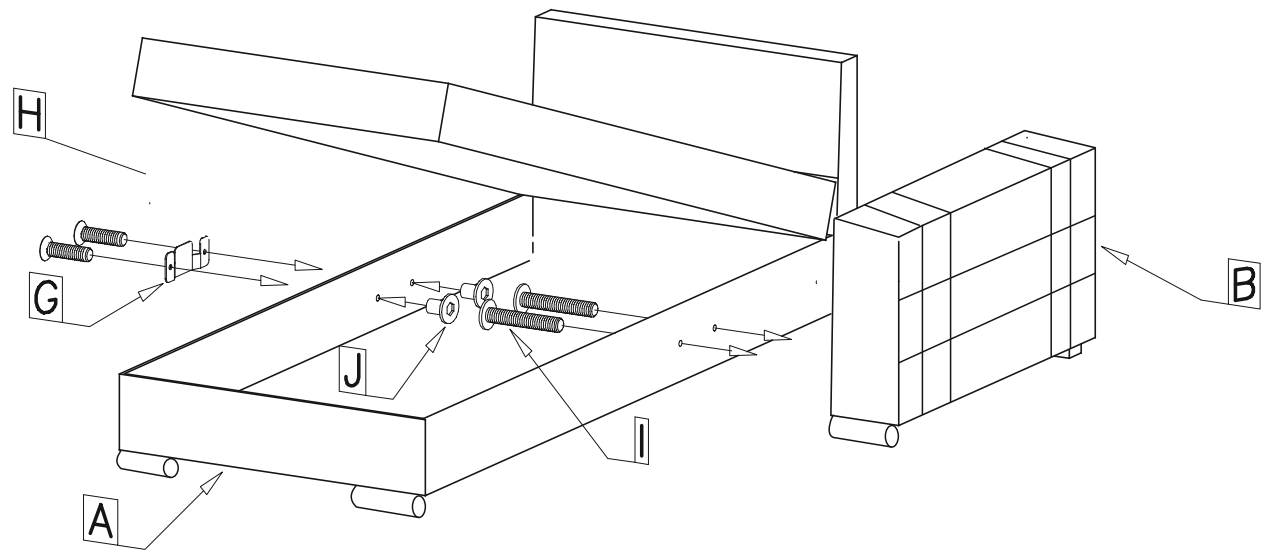
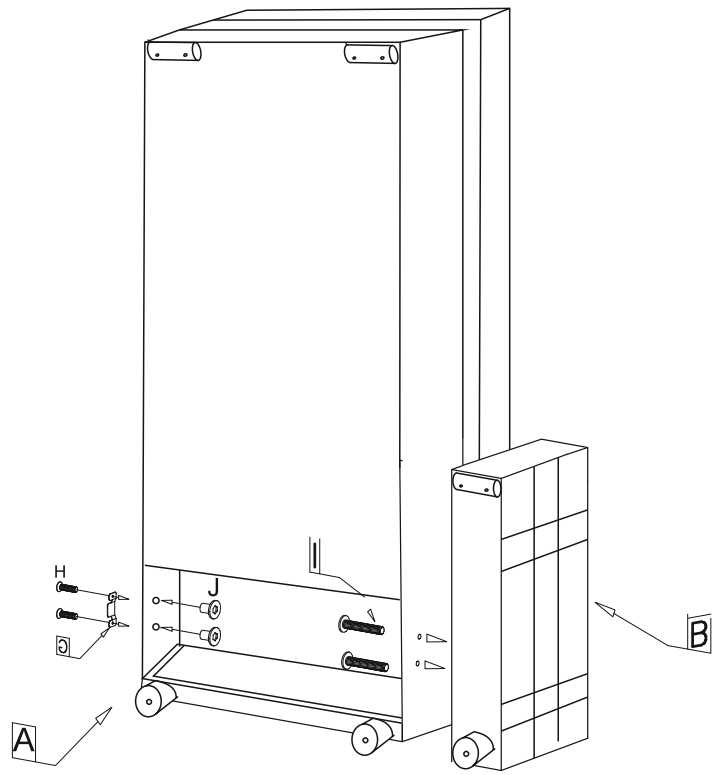

3

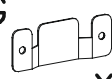
R

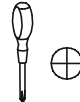

 x2	 x4	 x4	 x4	 L	
---	---	---	---	---	---

4

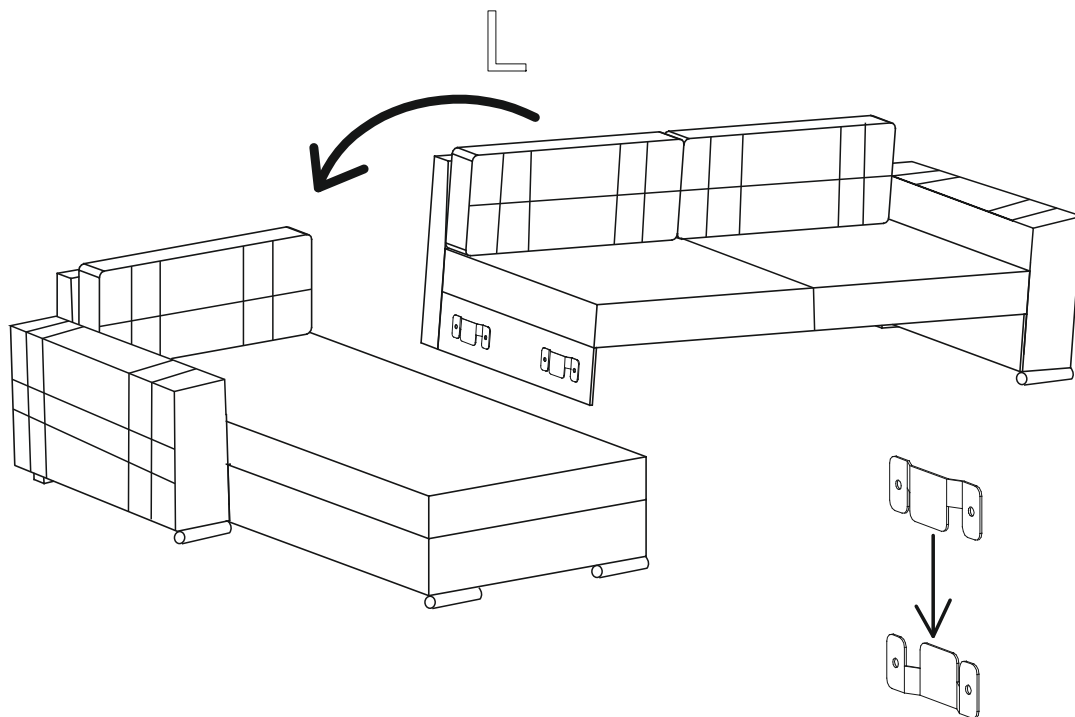

4

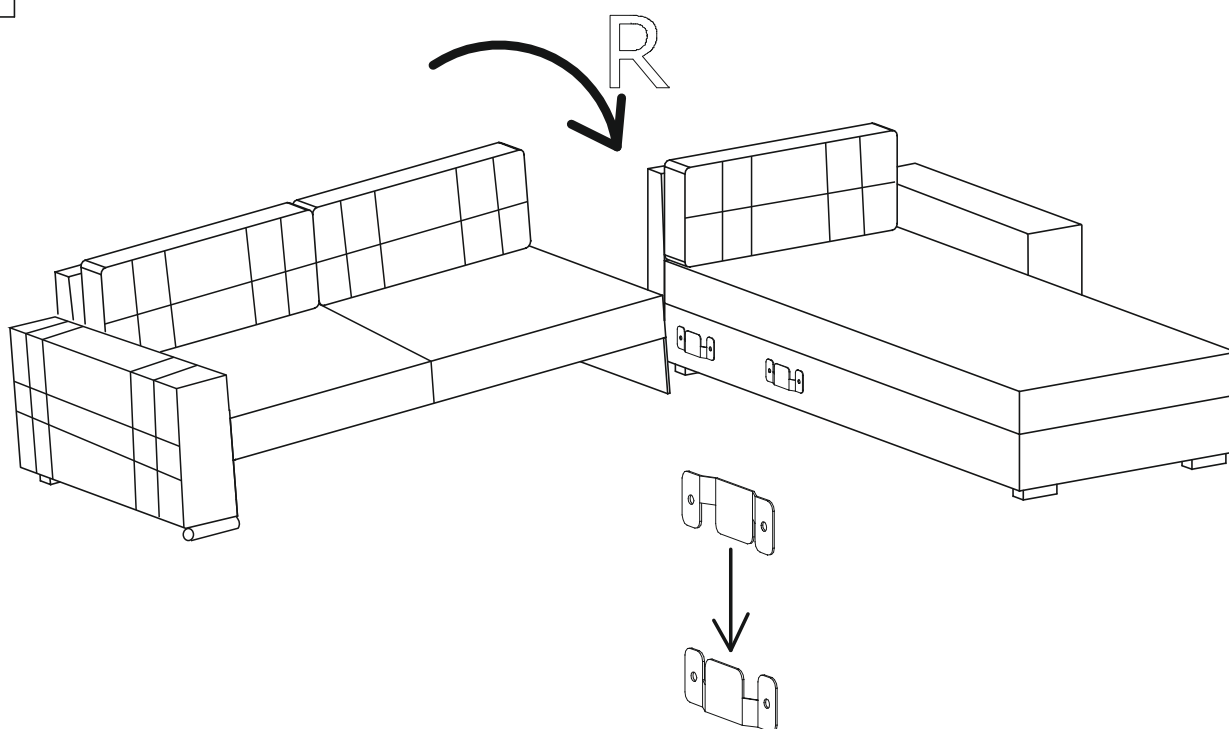

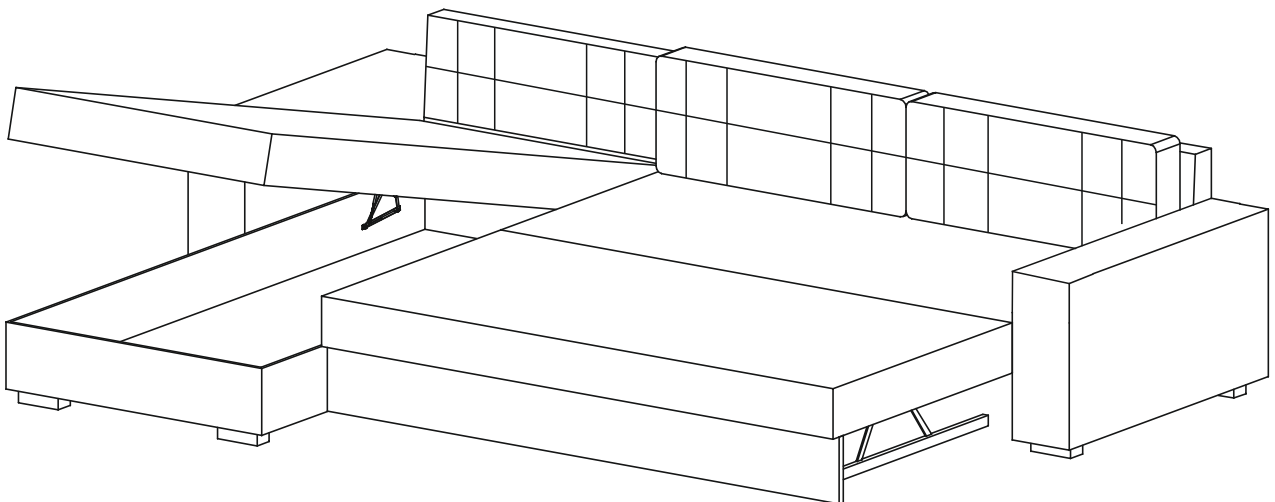
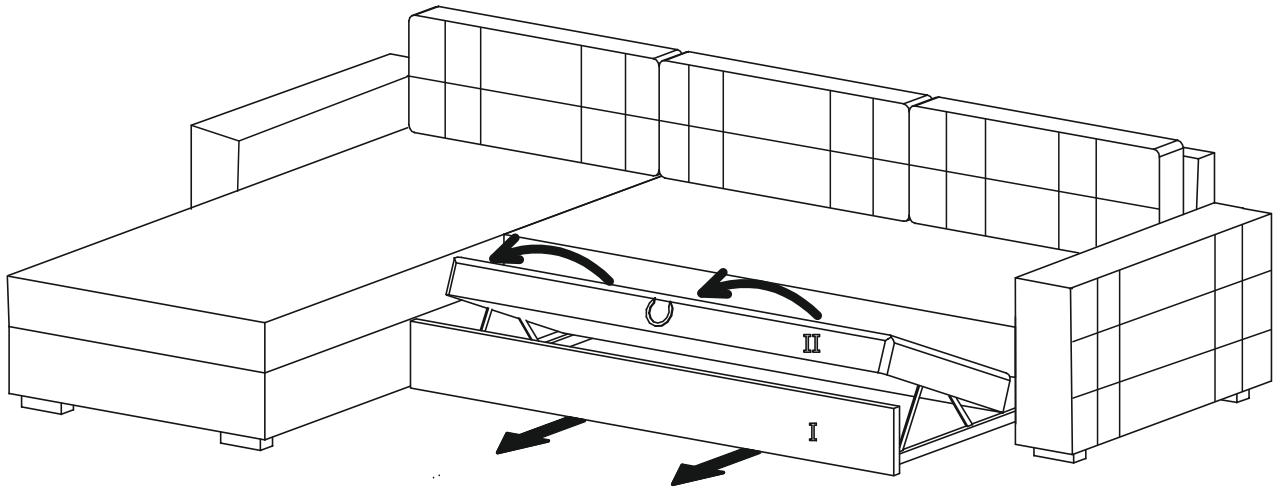

L

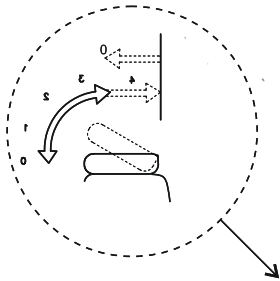
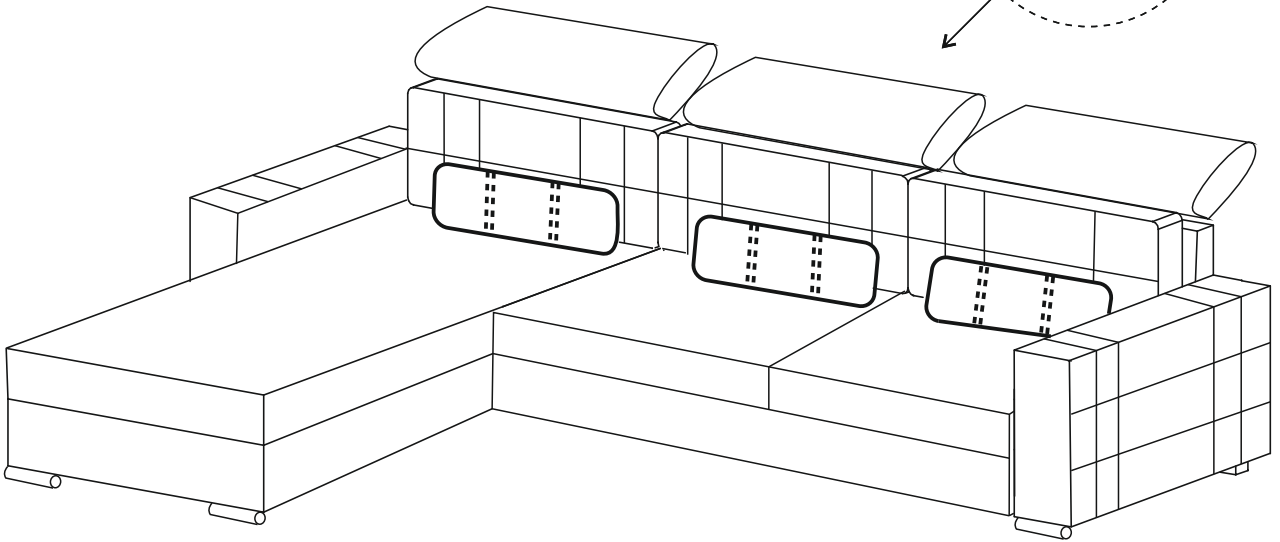
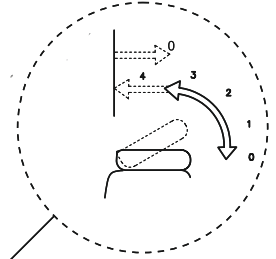

R

