

No	T(mm)	L(mm)	W(mm)	Stc.
1	16	300	400	1
2	16	267	386	1
3	16	2200	400	1
4	16	2200	400	1
5	16	267	386	4
6	16	267	384	3
7	3	1578	284	1
8	3	628	284	1

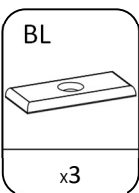

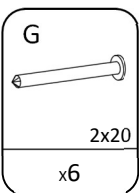

1

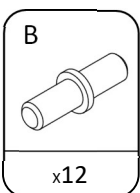
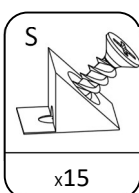
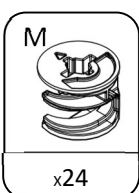
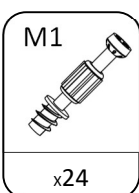
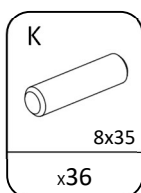
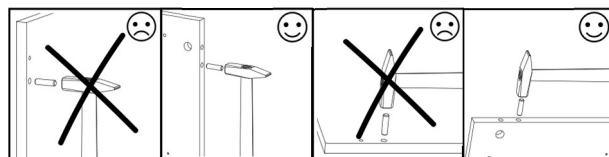
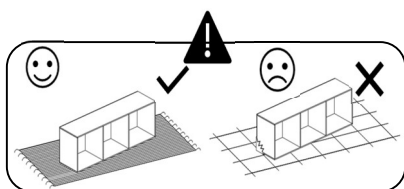
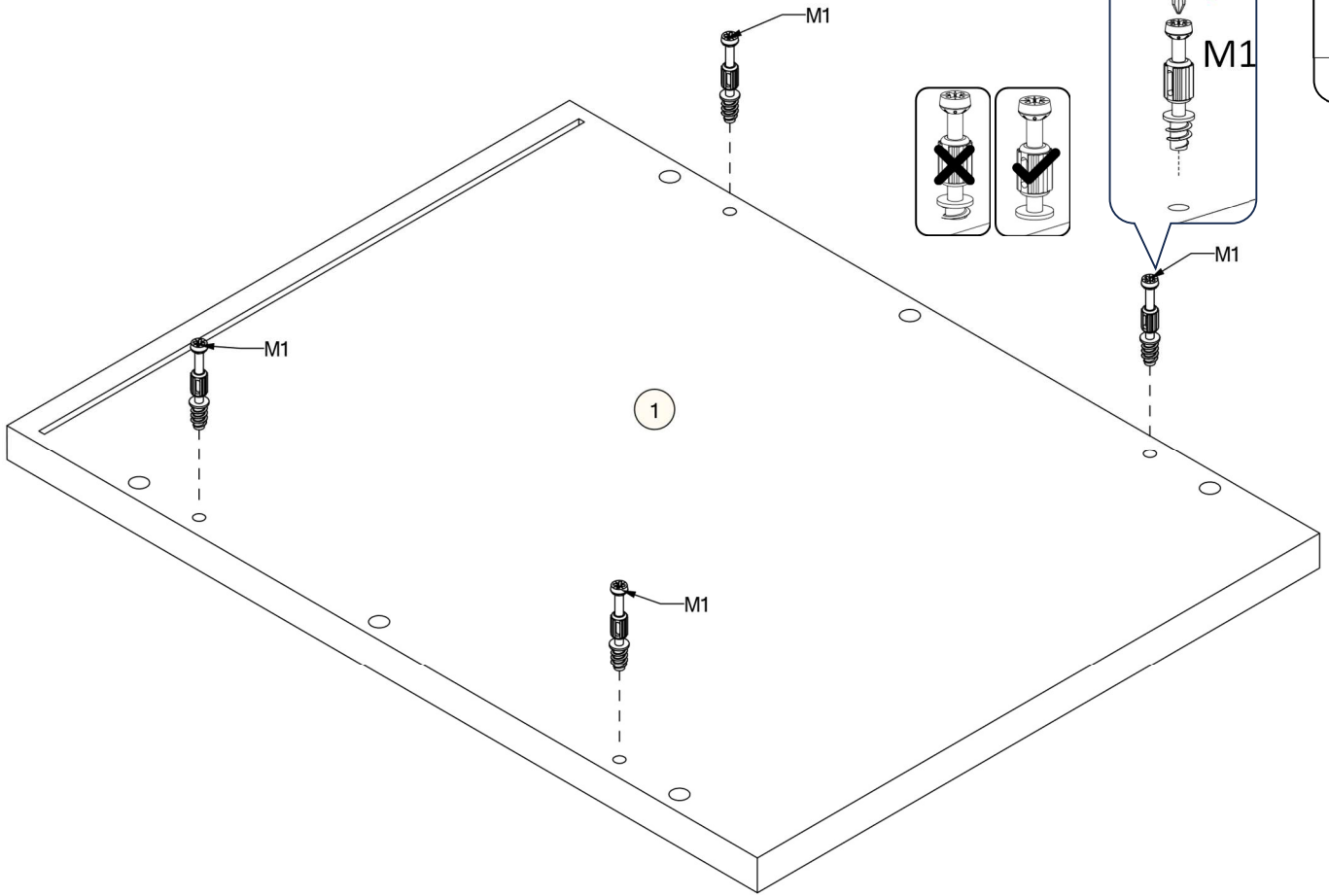

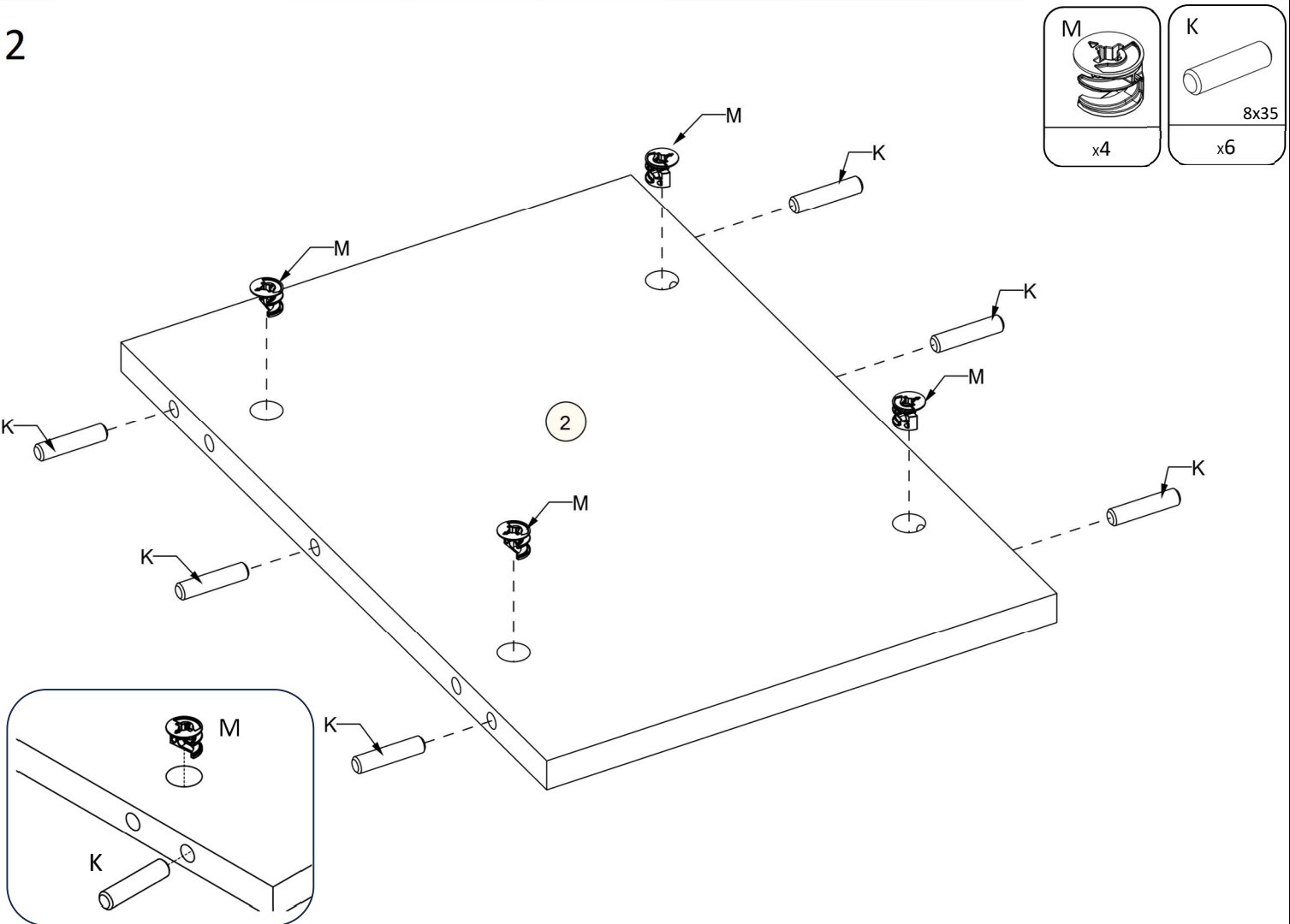
2



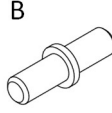
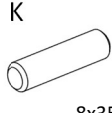

3

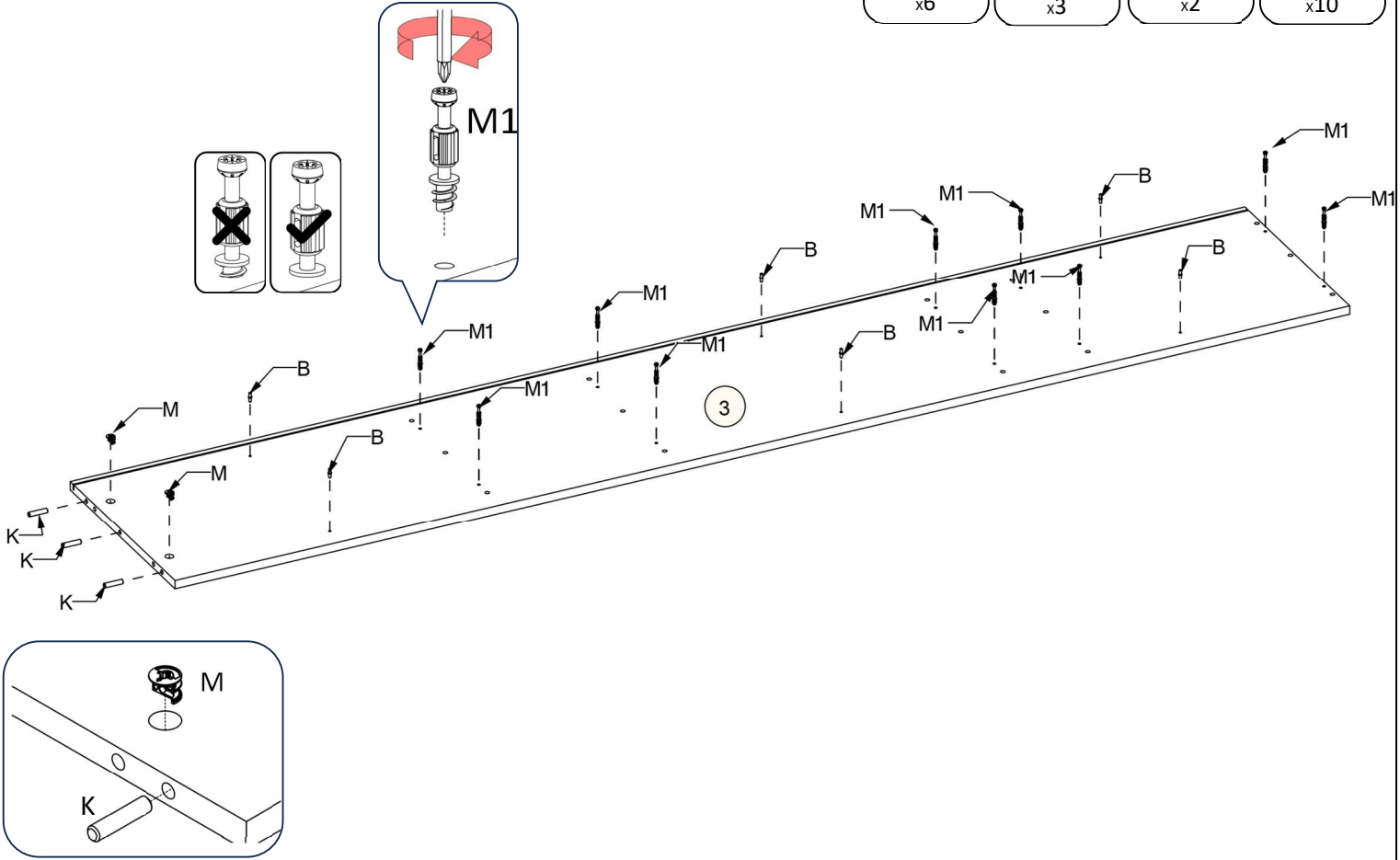
			
x6	8x35 x3	x2	x10

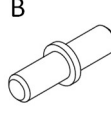
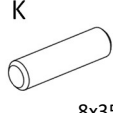

4

			
x6	8x35 x3	x2	x10

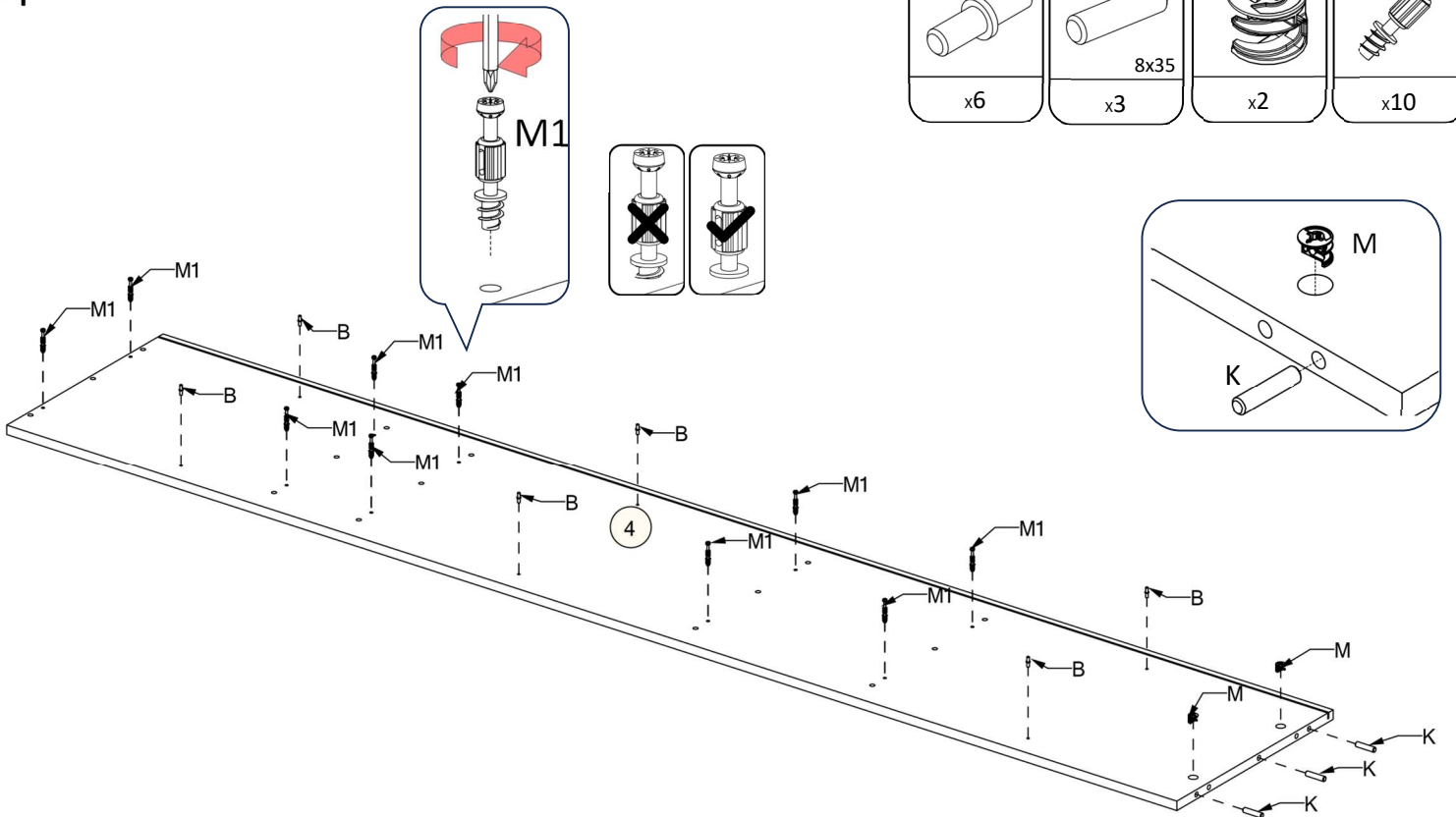

5

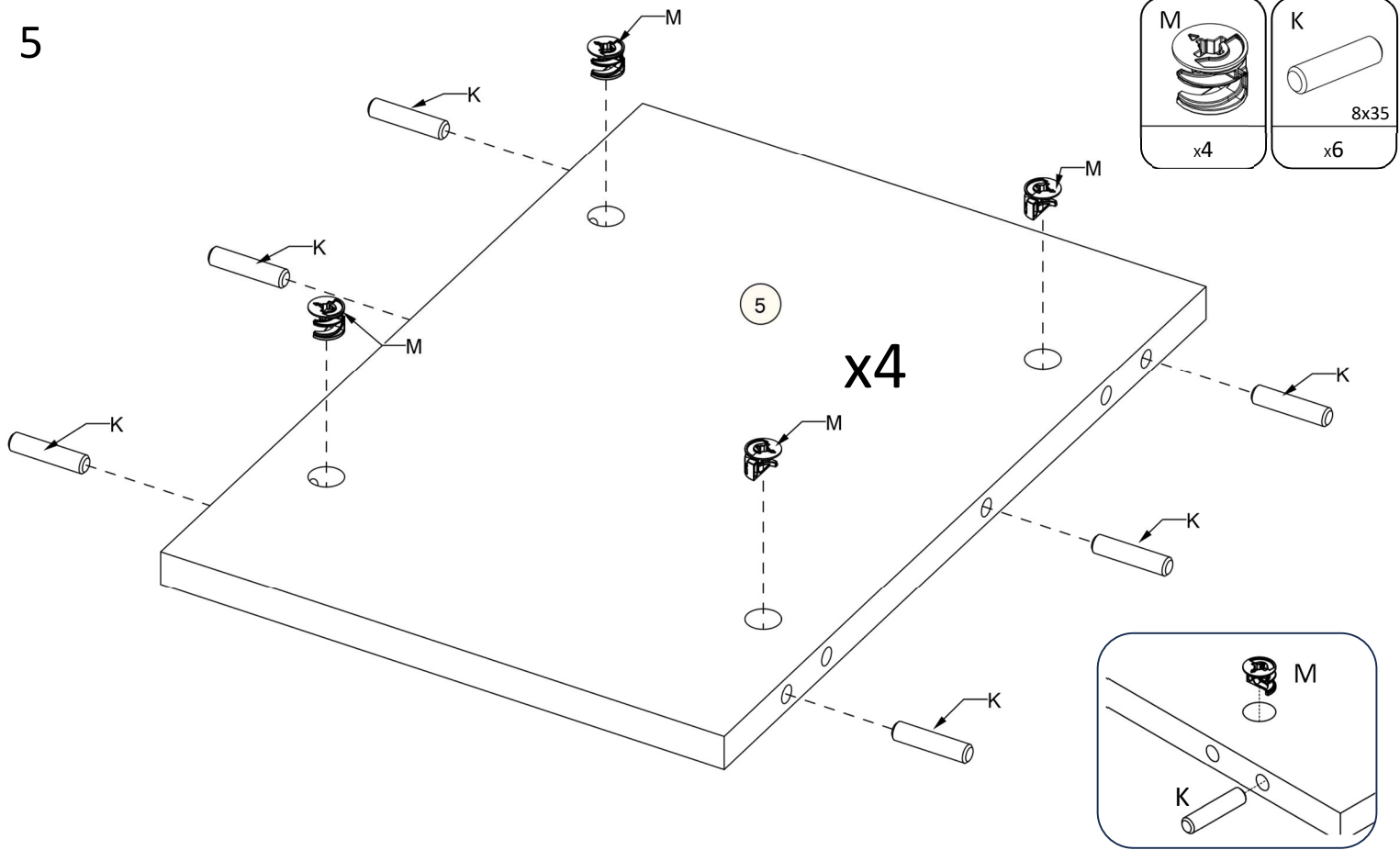

6

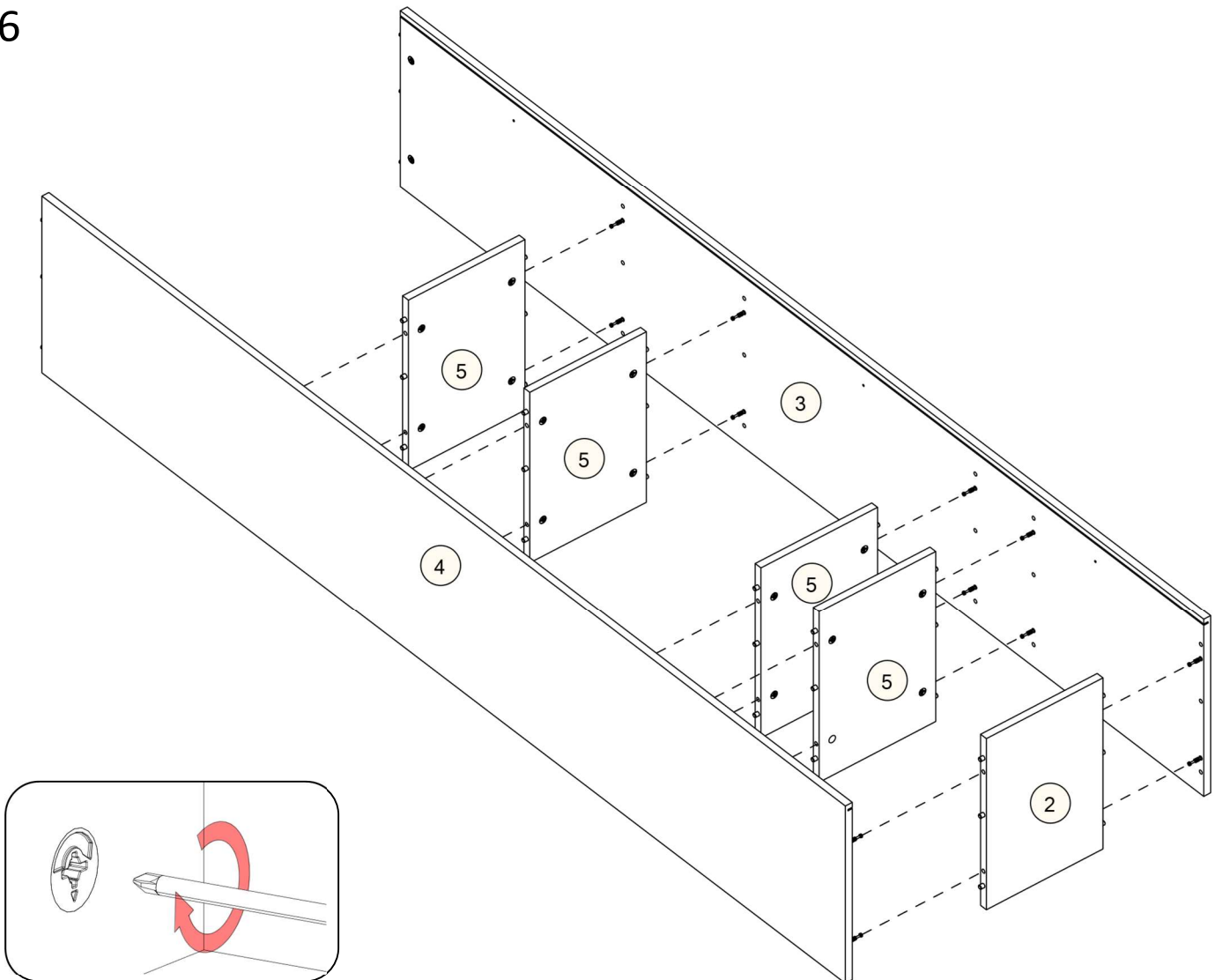

7

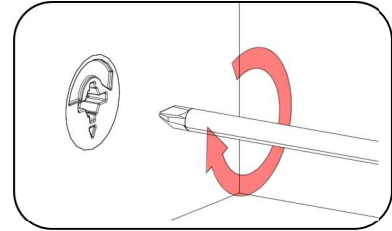
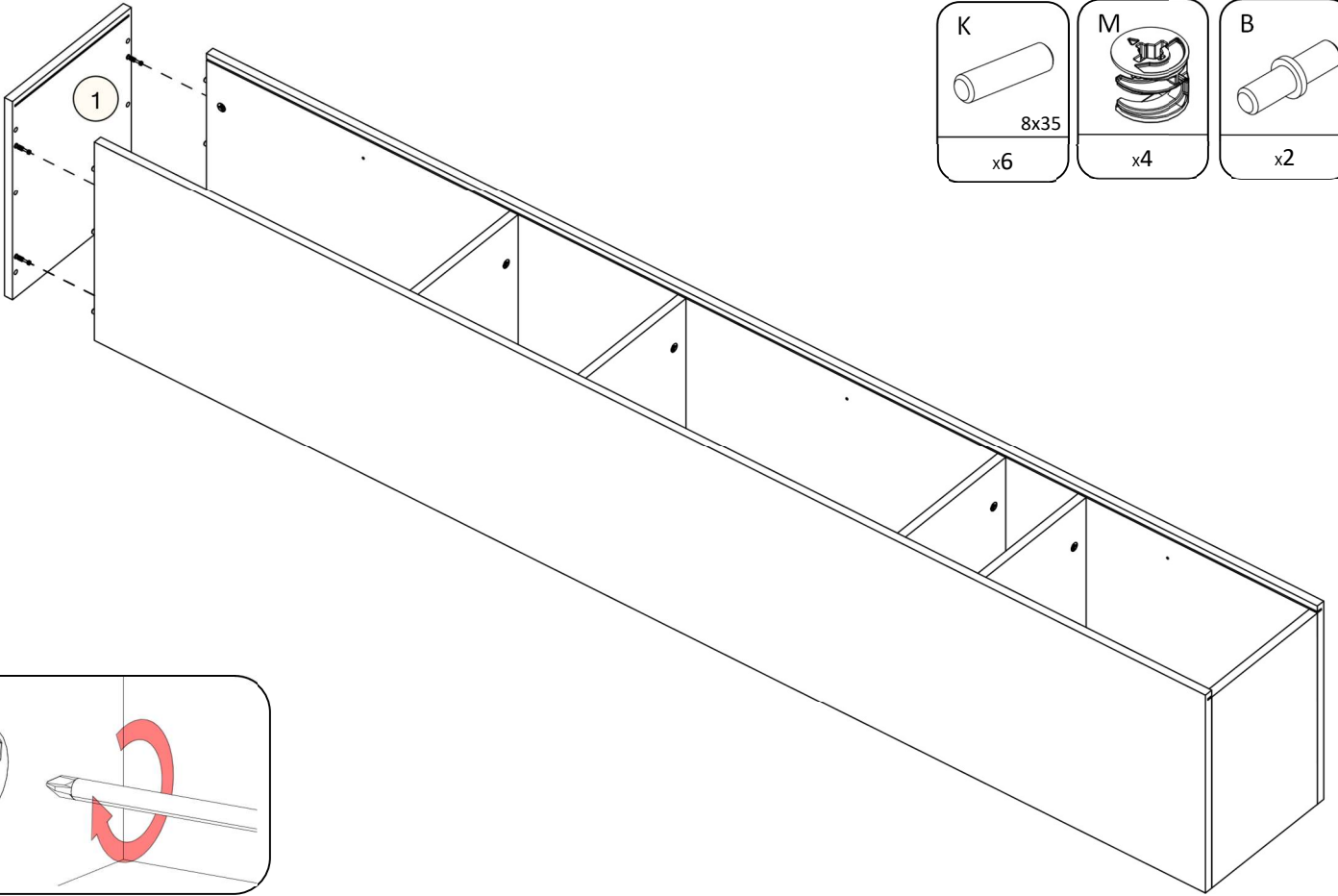

8

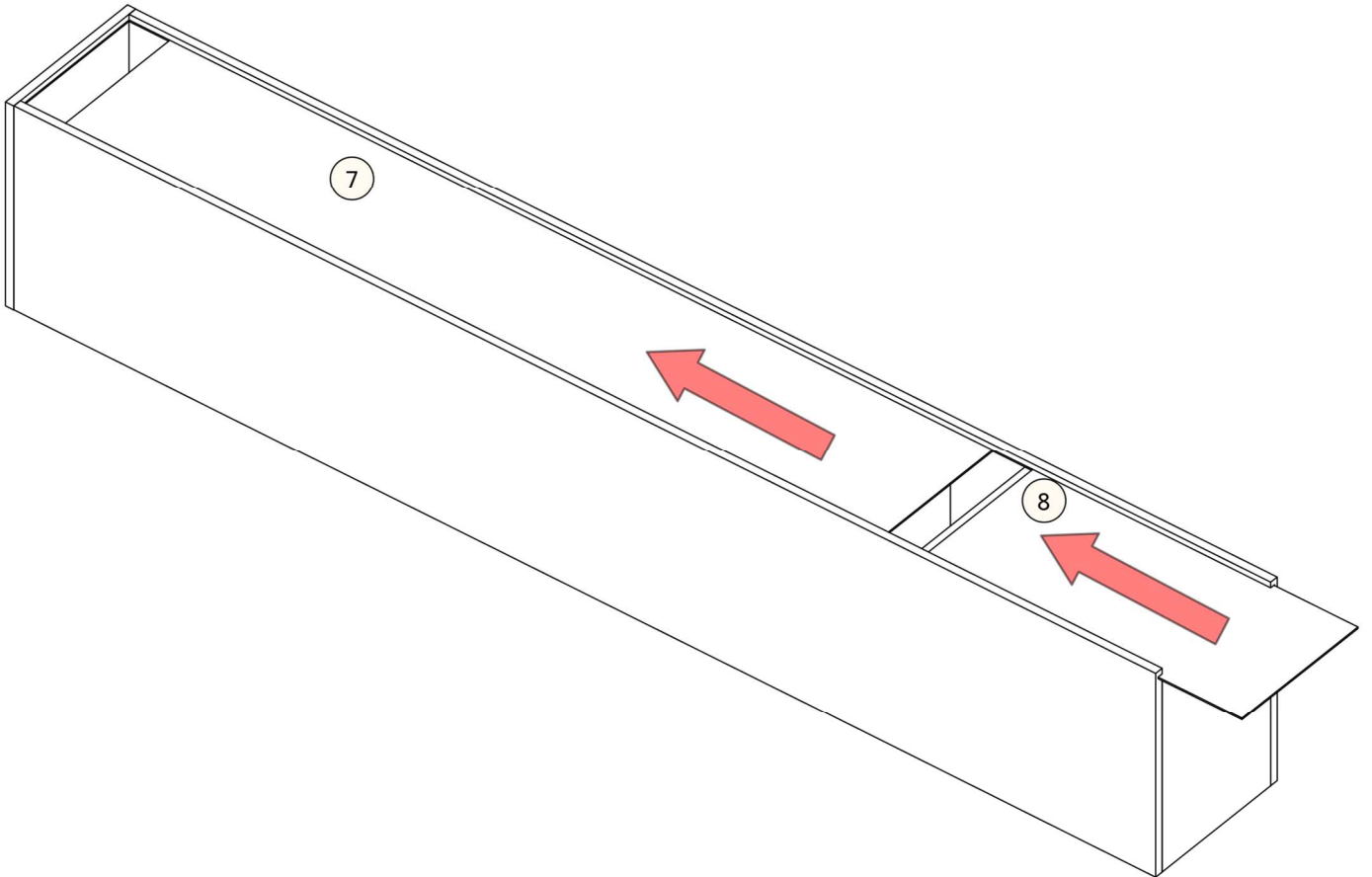

9

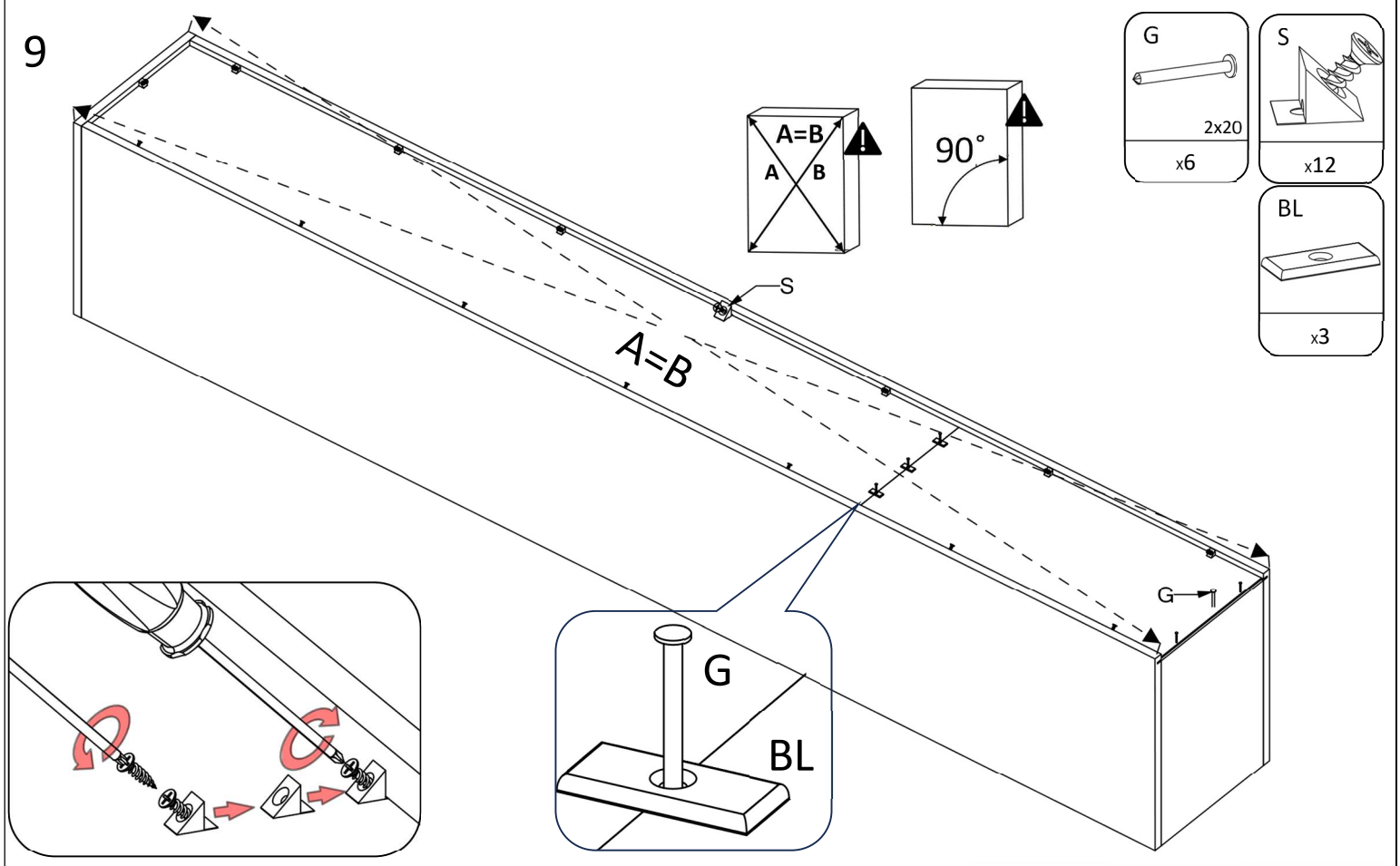

10

