

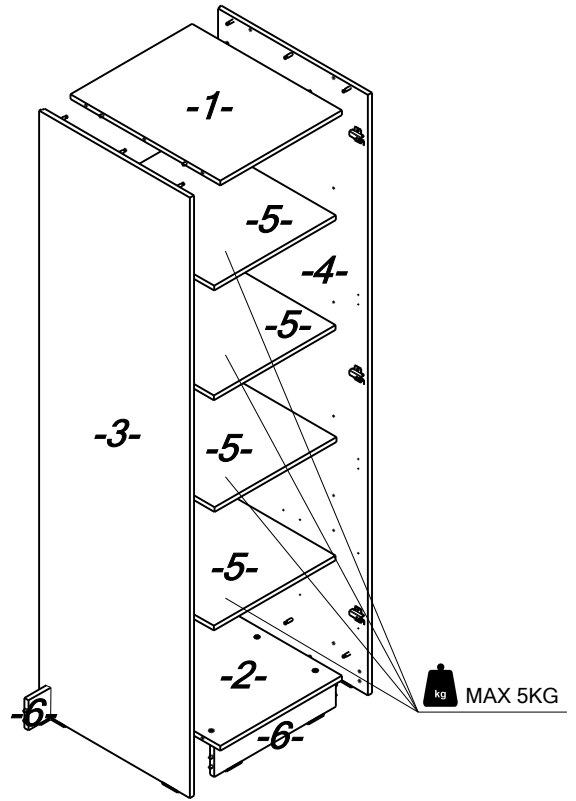

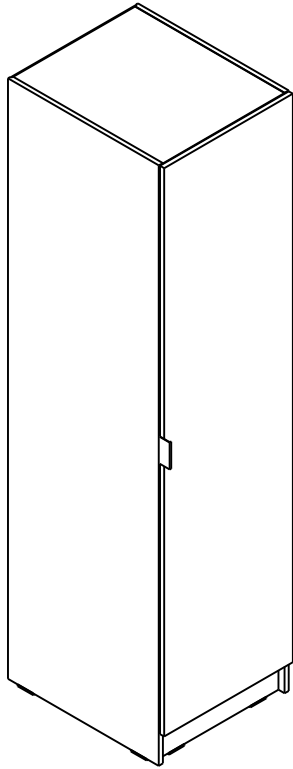

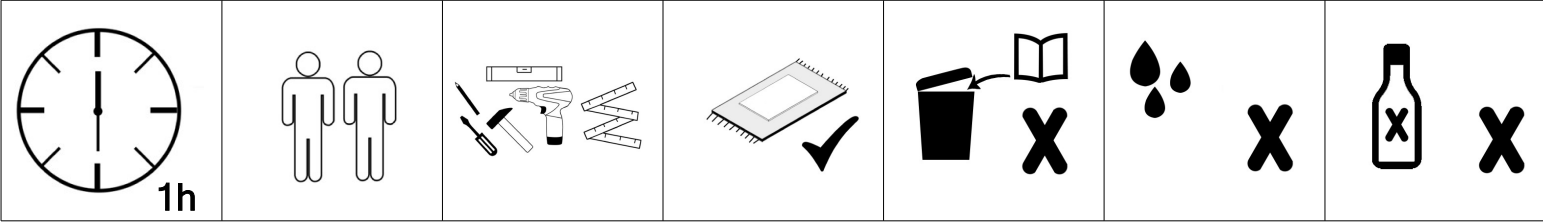

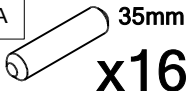







# MAXI SZAFKA 50



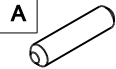

A	 35mm <b>x16</b>	B	 <b>x12</b>	C	 <b>x12</b>	D	 <b>x8</b>	E	 3,5x16 <b>x9</b>	F	 <b>x1</b>
G	 <b>x1</b>	H	 4x16 <b>x6</b>	J	 <b>x3</b>	K	 <b>x3</b>	L	 <b>x60</b>	M	 <b>x16</b>

	WYMIARY ELEM.		WYMIARY ELEM.
-1-	468x576	-5-	4x 468x550
-2-	468x576	-6-	2x 468x100
-3-	2000x580	-7-	1893x496
-4-	2000x580	-8-	1898x482

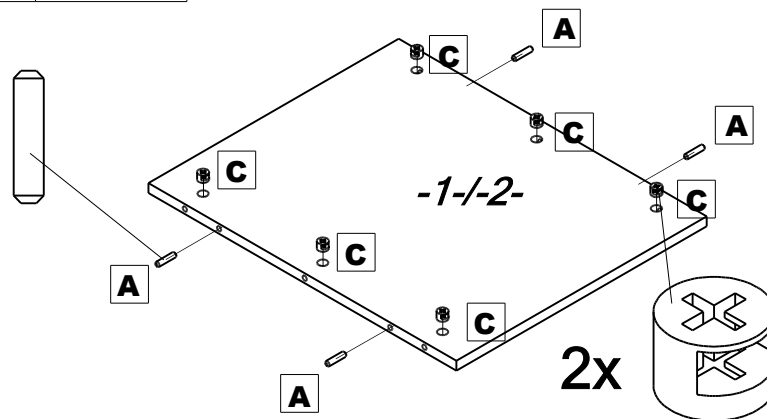
<b>1</b>		
	x8	x12

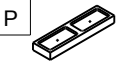

<b>2</b>			
	x4	x8	x16

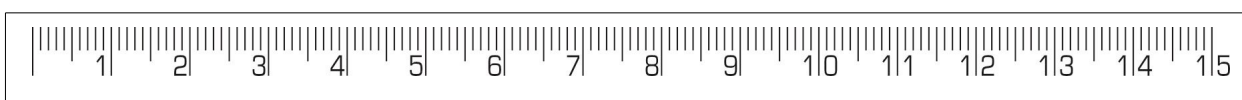
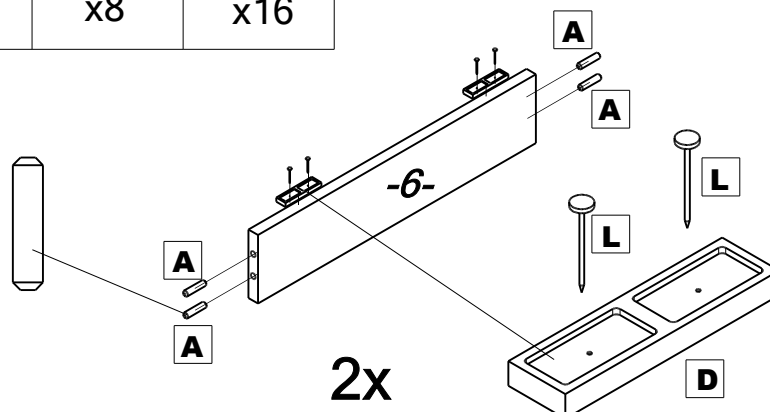

<b>3</b>	M	L	B	D
	x8	x4	x6	x2

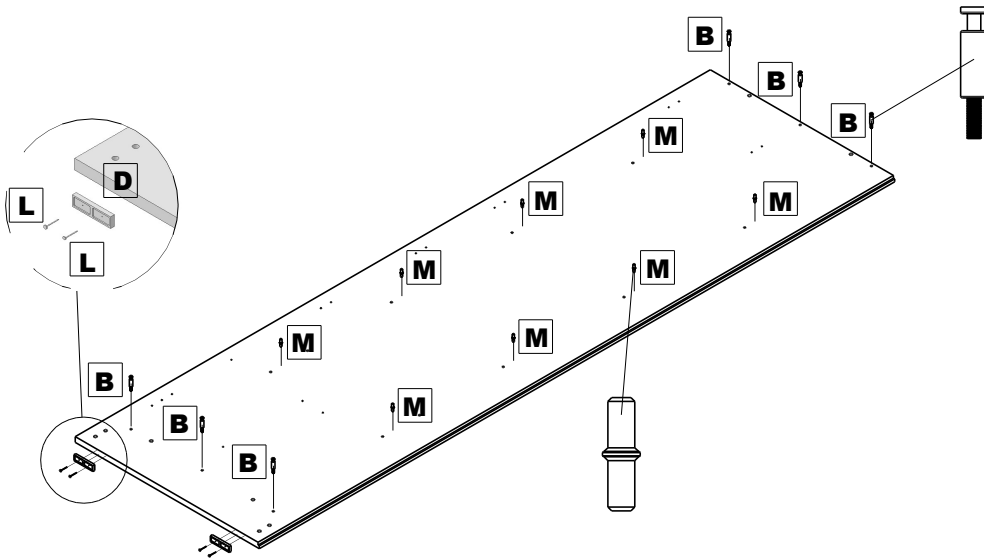

<b>4</b>	J	L	H	D	B	M
	x3	x4	4x16	x2	x8	x8

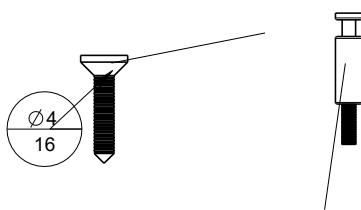
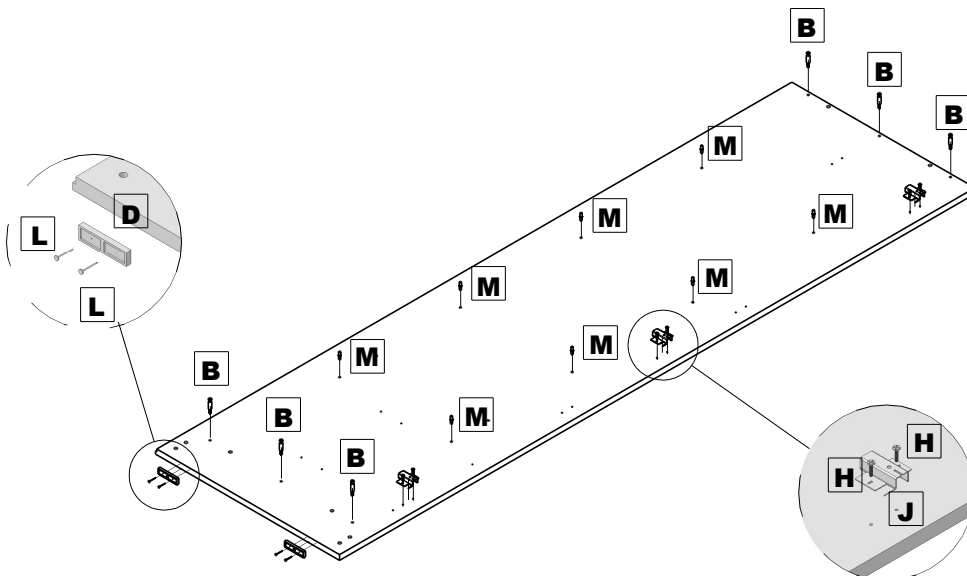



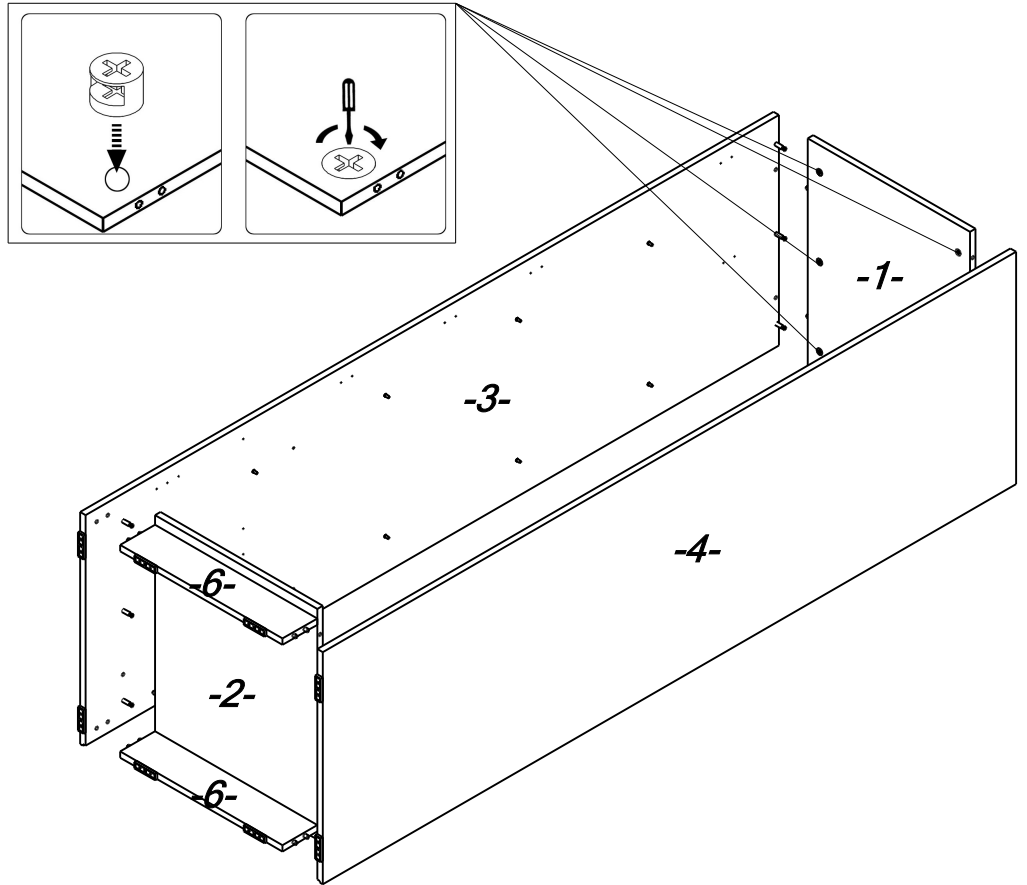

5

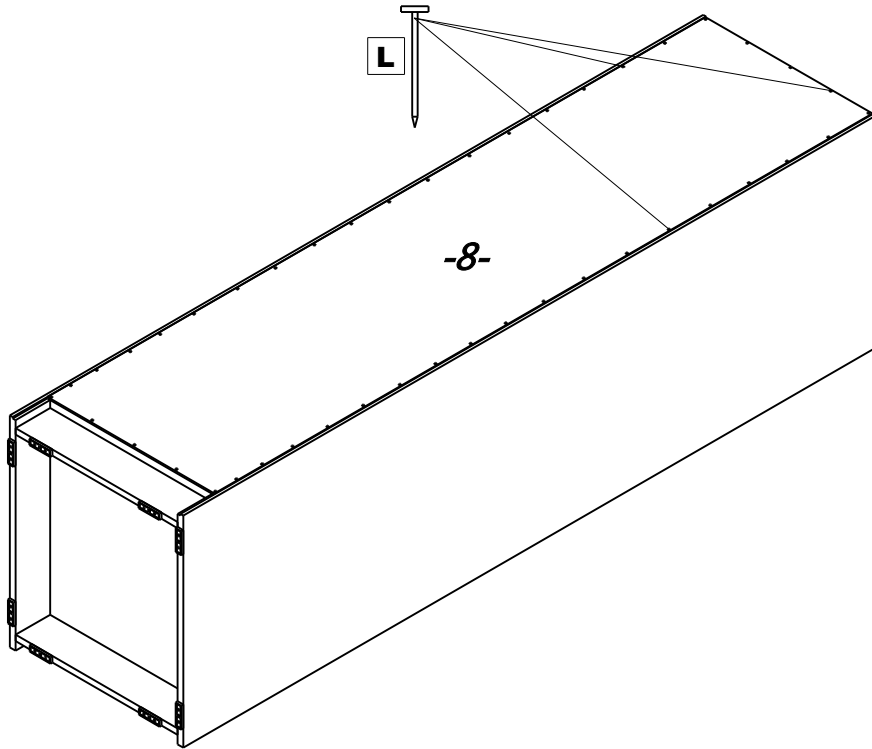

6

L	
x50	



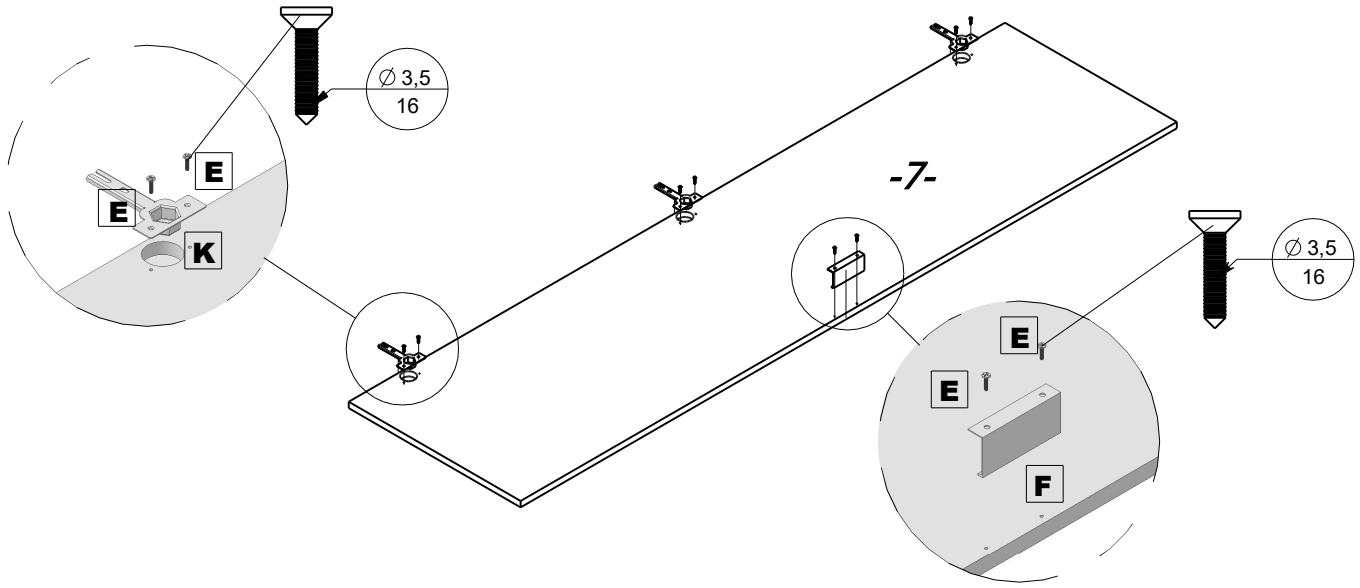

7	K	E	F
		 3,5x16	
	x3	x6	x1

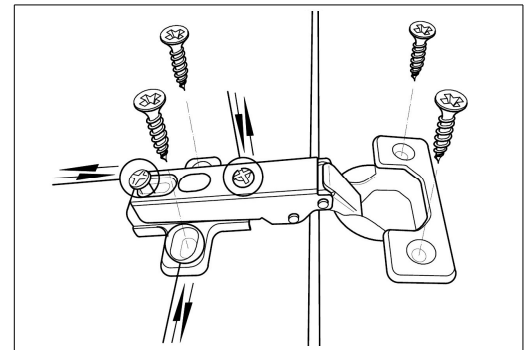
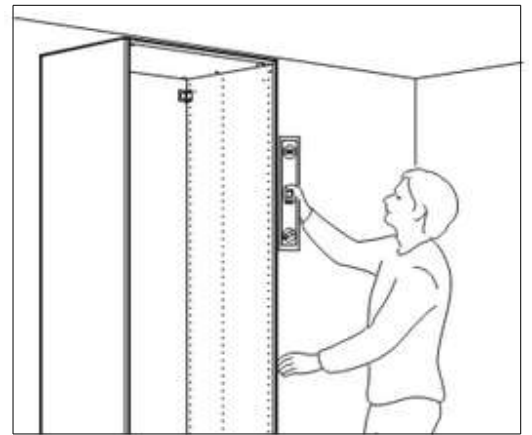
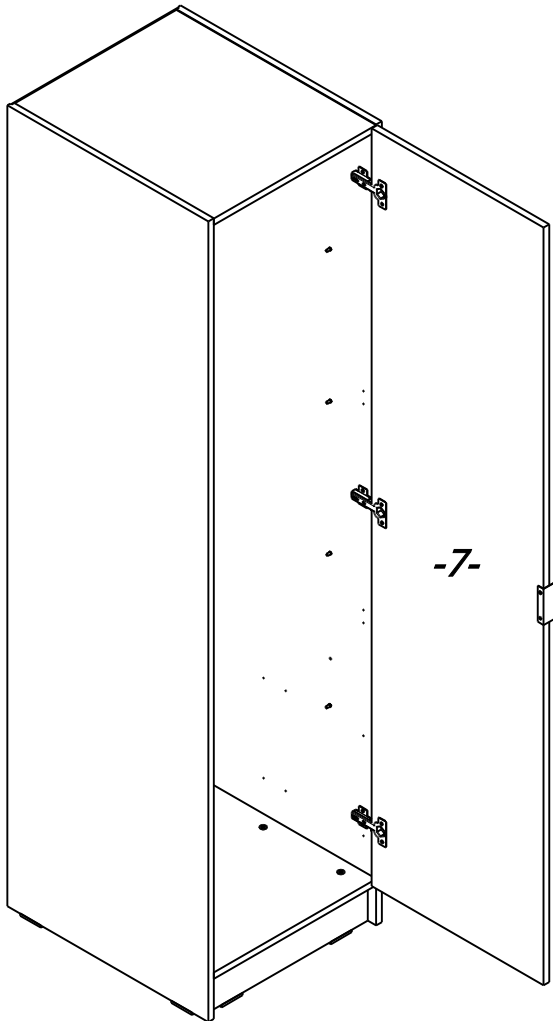

8



9	G		E	
		x1		3,5x16

