

MARIT

INSTRUKCJA MONTAŻU

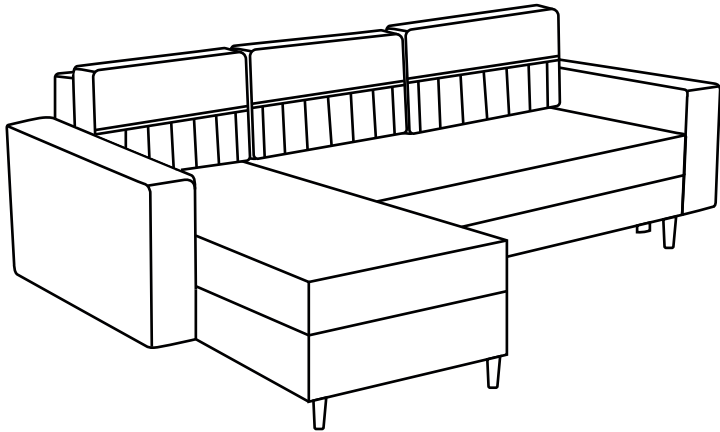

LEWA STRONA

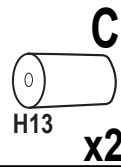
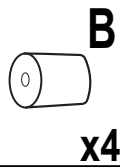
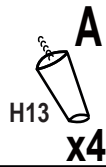
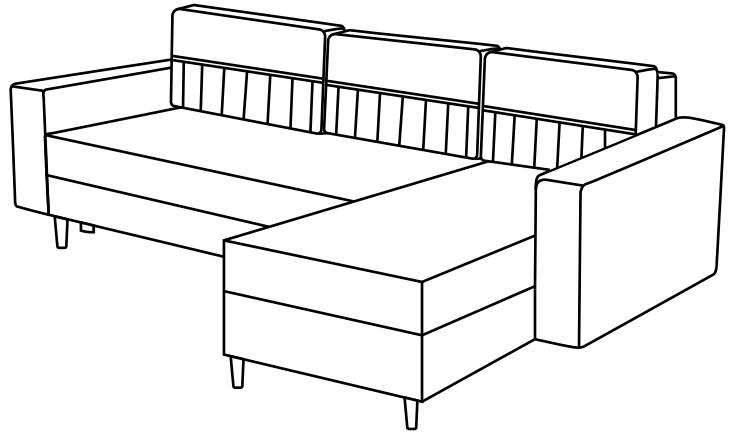

PRAWA STRONA

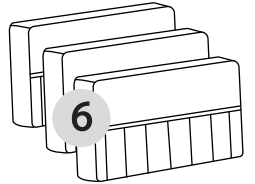
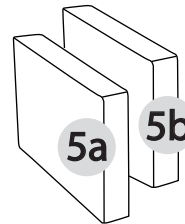
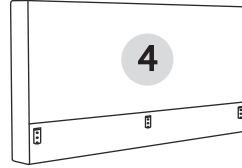
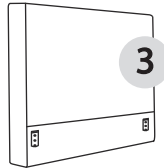
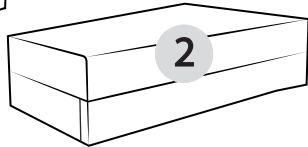
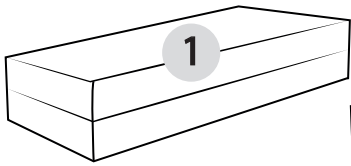

KROK 1

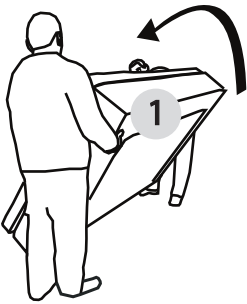

KROK 2

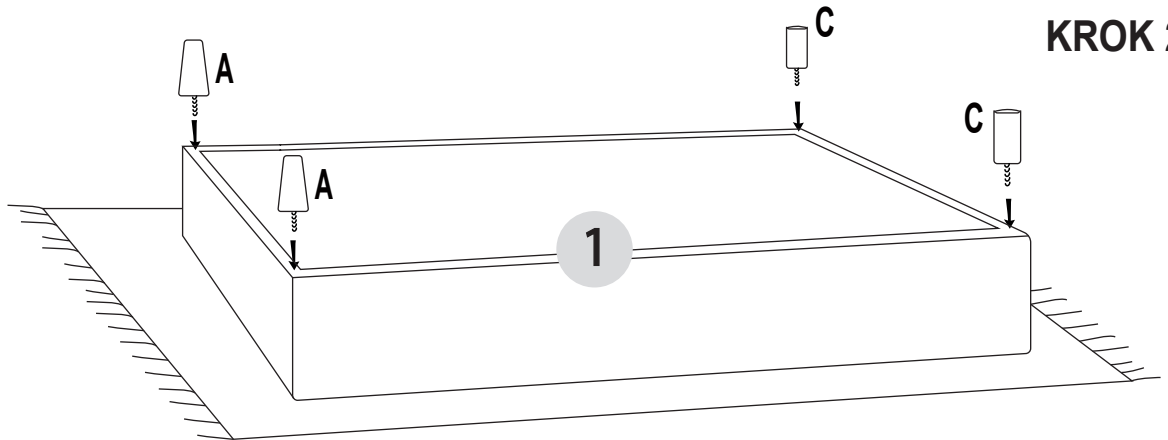

KROK 3

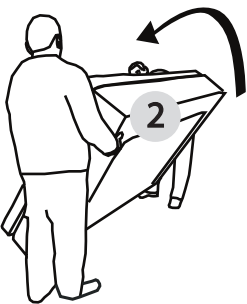

KROK 4

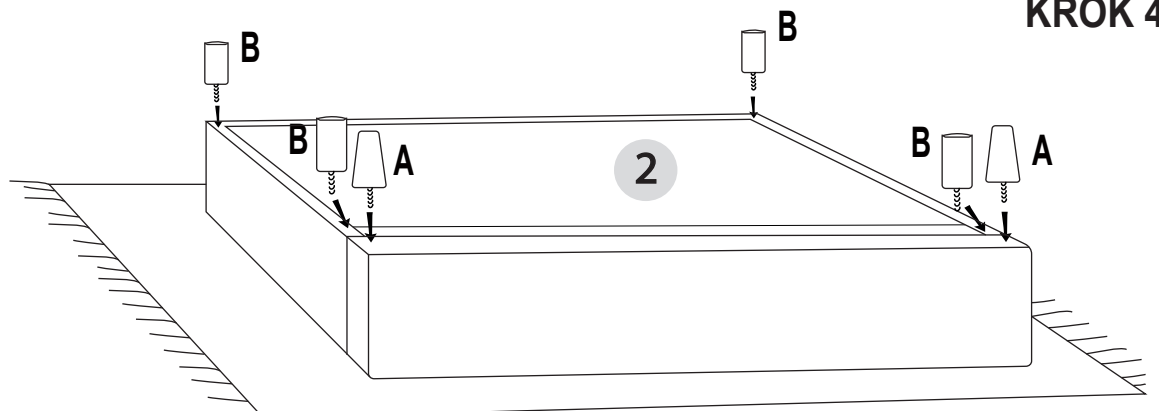

LEWA STRONA KROK 5

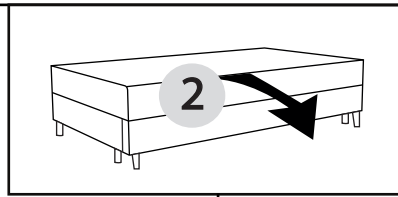
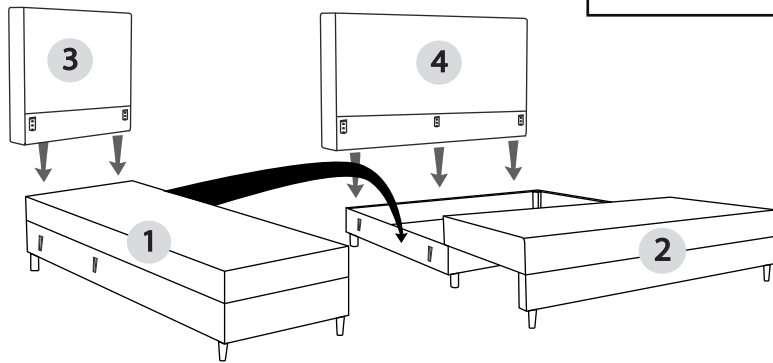

LEWA STRONA KROK 6

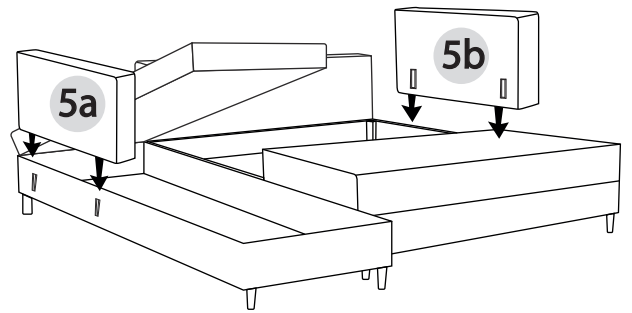

PRAWA STRONA KROK 5

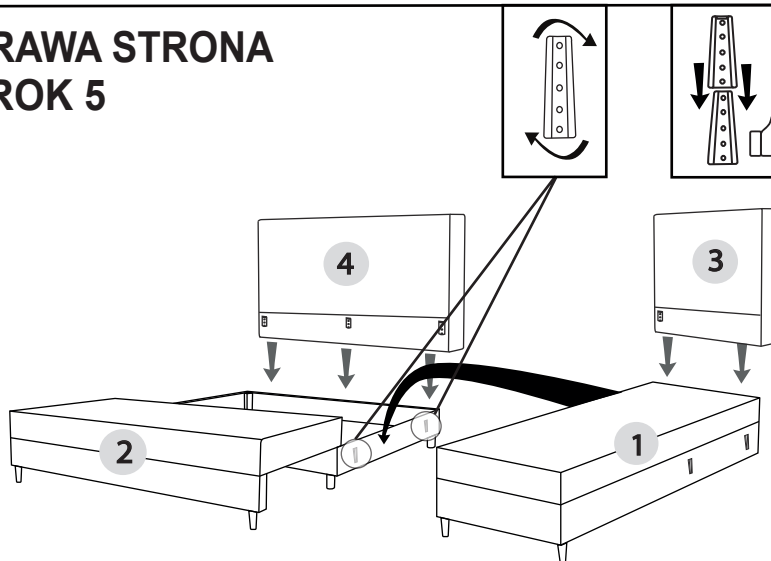

PRAWA STRONA KROK 6

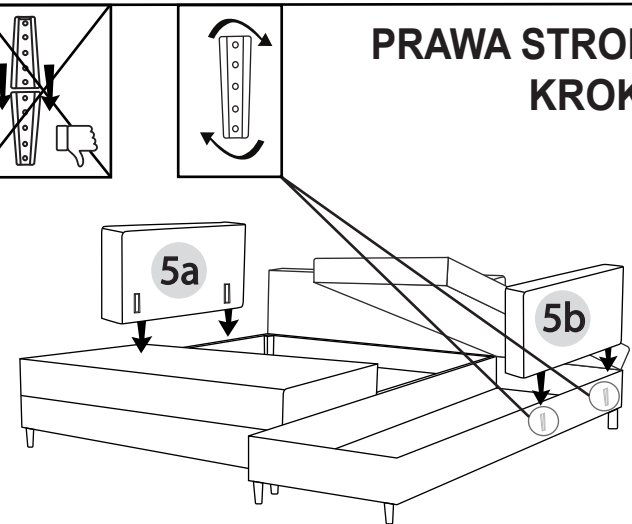

KROK 7

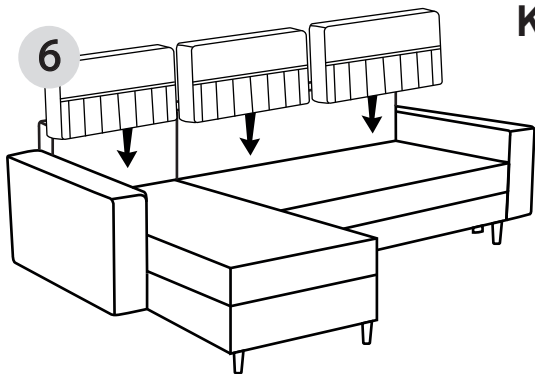

FUNKCJE

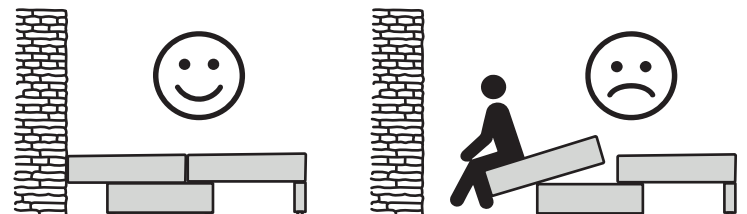
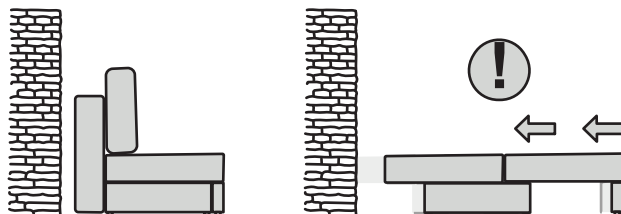
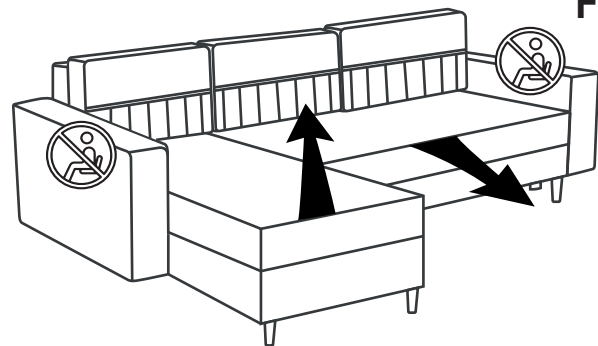

Mebel ustawiać w odległości nie mniejszej niż 1m od grzejników.



Niedozwolone jest siadanie na podłokietnikach, oparciach oraz miękkich elementach konstrukcyjnych.



Niedozwolone jest powodowanie dużego obciążenia w miejscach do tego nie przystosowanych.



Mebel należy przechowywać w pomieszczeniach o temp. 15-30°C oraz wilgotności 40-70 %.



Przy przemieszczaniu mebli należy zabezpieczyć wszystkie elementy tapicerowane przed uszkodzeniem mechanicznym.



Przy rozpakowywaniu nie wolno używać ostrych, niebezpiecznych narzędzi.



Podczas przenoszenia trzymać za stałe elementy konstrukcyjne.



Mebel użytkowane powinny być zgodnie z ich przeznaczeniem.