

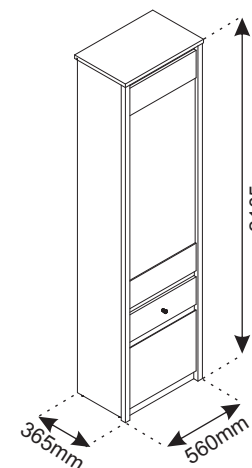

Instrukcja montażowa

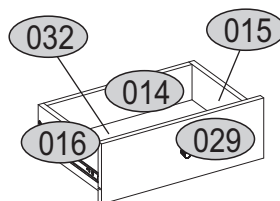

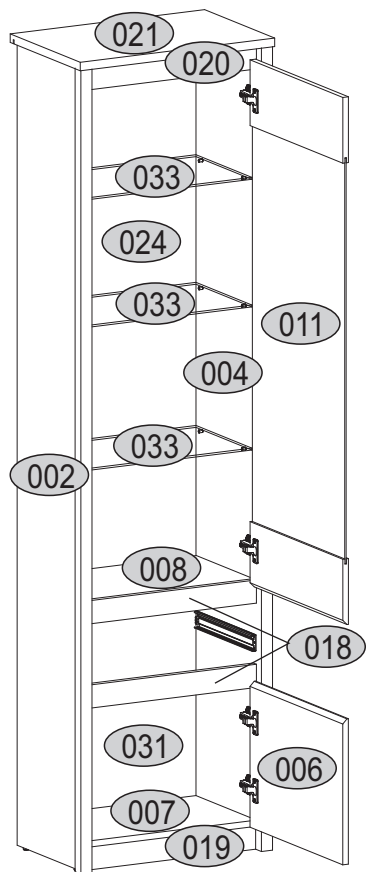

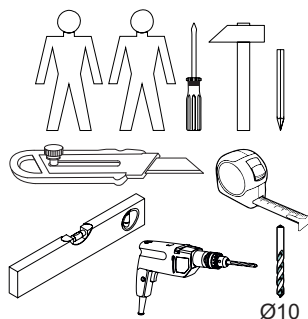
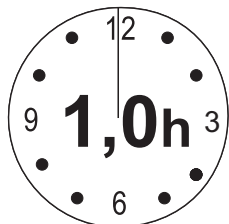

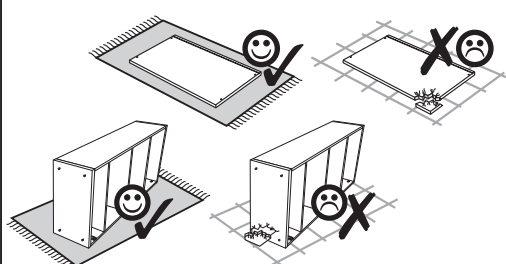
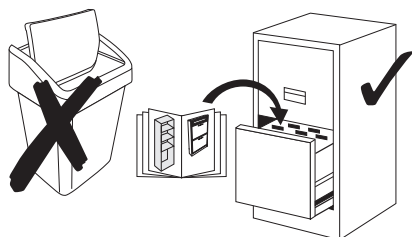









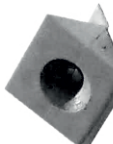

KARIN Witryna wysoka 1D1W1S



Kod	Wymiary				Pakiet
	2078	360	16/32	1	
002	2078	360	16/32	1	1/3
004	2078	360	16/32	1	1/3
006	376	482	16	1	1/3
007	488	334	16	1	1/3
008	488	296	16	1	1/3
011	1364	482	16	1	2/3
014	431	120	16	1	1/3
015	300	120	16	1	1/3
016	300	120	16	1	1/3
018	70	488	16	2	1/3
019	488	60	16	1	1/3
020	488	60	16	1	1/3
021	560	364	22	1	1/3
024	1401	507	2,5	1	1/3
029	482	170	16	1	1/3
031	620	507	2,5	1	1/3
032	302	449	2,5	1	1/3
033	488	290	5	3	3/3
Akcesoria				1	1/3







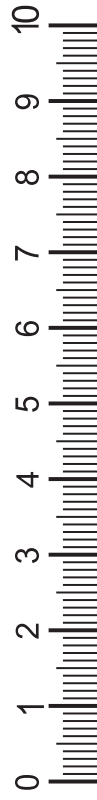
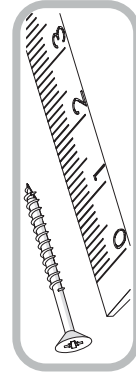

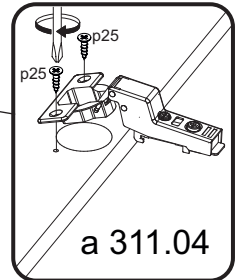
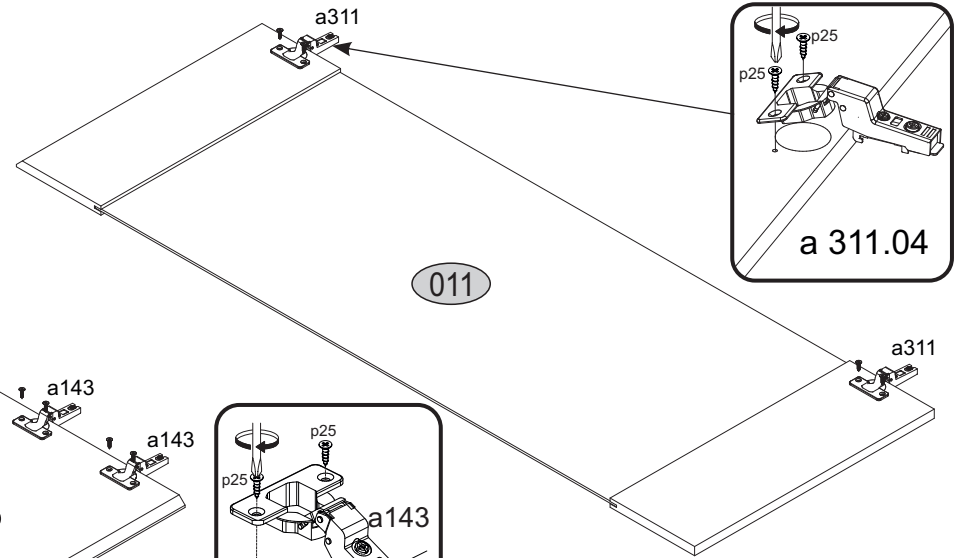
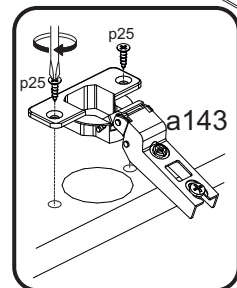
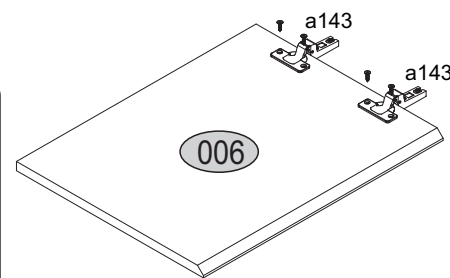
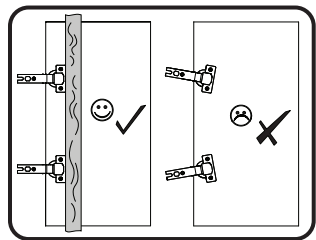
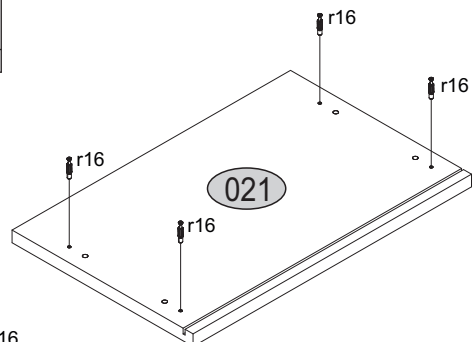
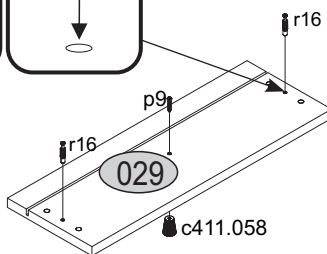
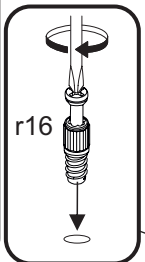
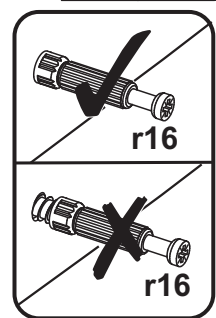
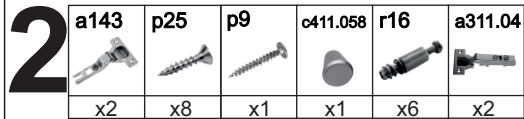
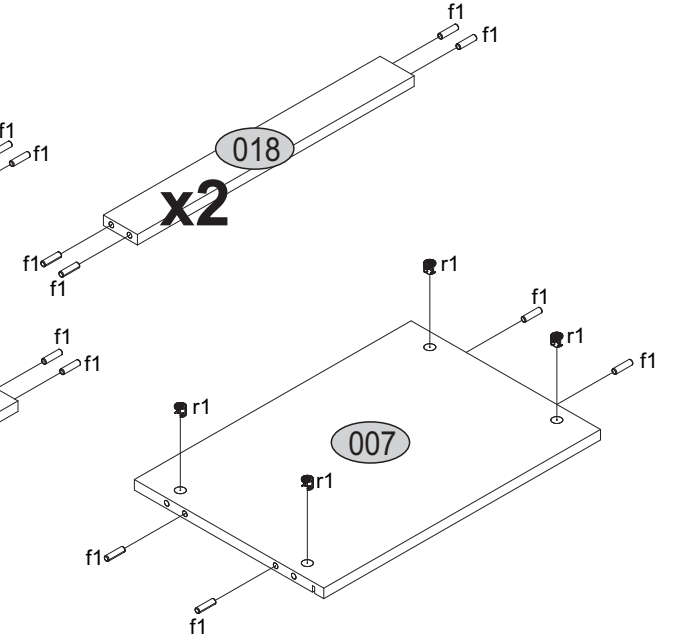
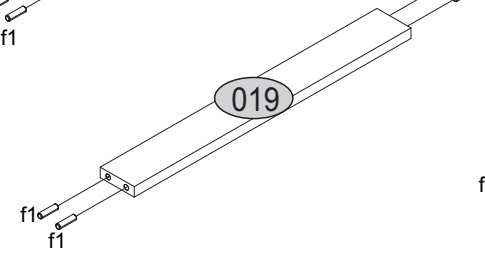
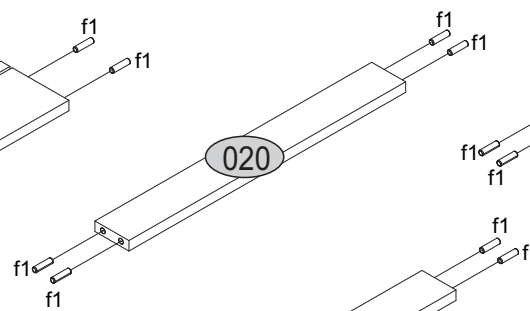
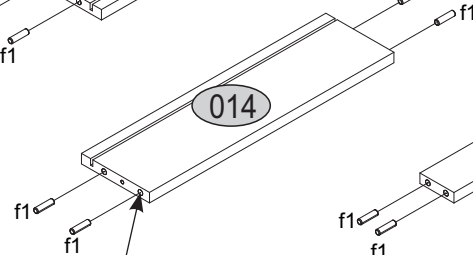
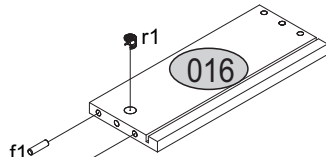
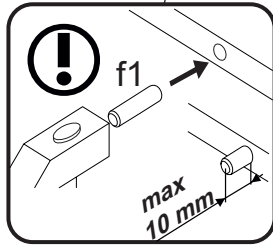
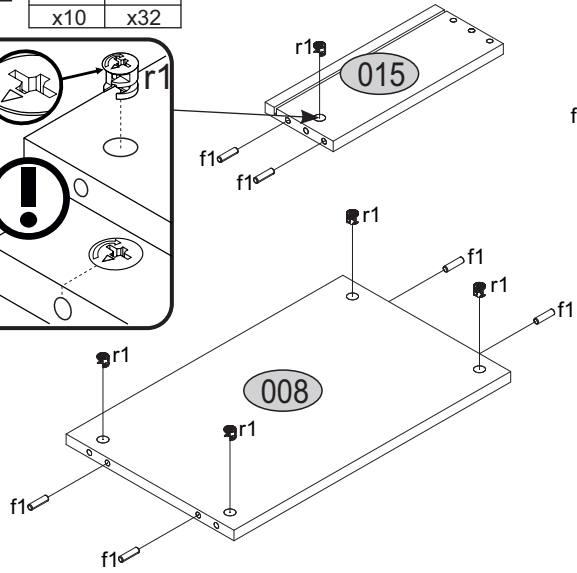
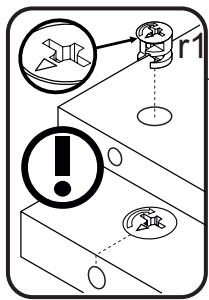
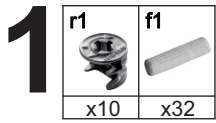

Akcesoria:

<p>36x f1 Ø8x30</p> 	<p>14x r1 15x12</p> 	<p>14x r16 Ø5x24</p> 	<p>2x e1 Ø7x50</p> 
<p>38x p25 Ø3.5x16</p> 	<p>1x f3</p> 	<p>1x lb-300</p> 	<p>6x s2</p> 
<p>1x p17 Ø6.0x50</p> 	<p>14x l2</p> 	<p>1x z1</p> 	<p>2x n260.01</p> 
<p>1x p9</p> 	<p>1x c411.058</p> 	<p>4x k1</p> 	<p>12x d3</p> 
<p>2x a143</p> 	<p>2x b119</p> 	<p>1x n14</p> 	<p>2x b219</p> 
<p>2x a311.04</p> 			





3

r1	r16	f1	lb-300	p25	b119	k1	d3	b219
								
x4	x8	x4	x1	x6	x2	x4	x12	x2

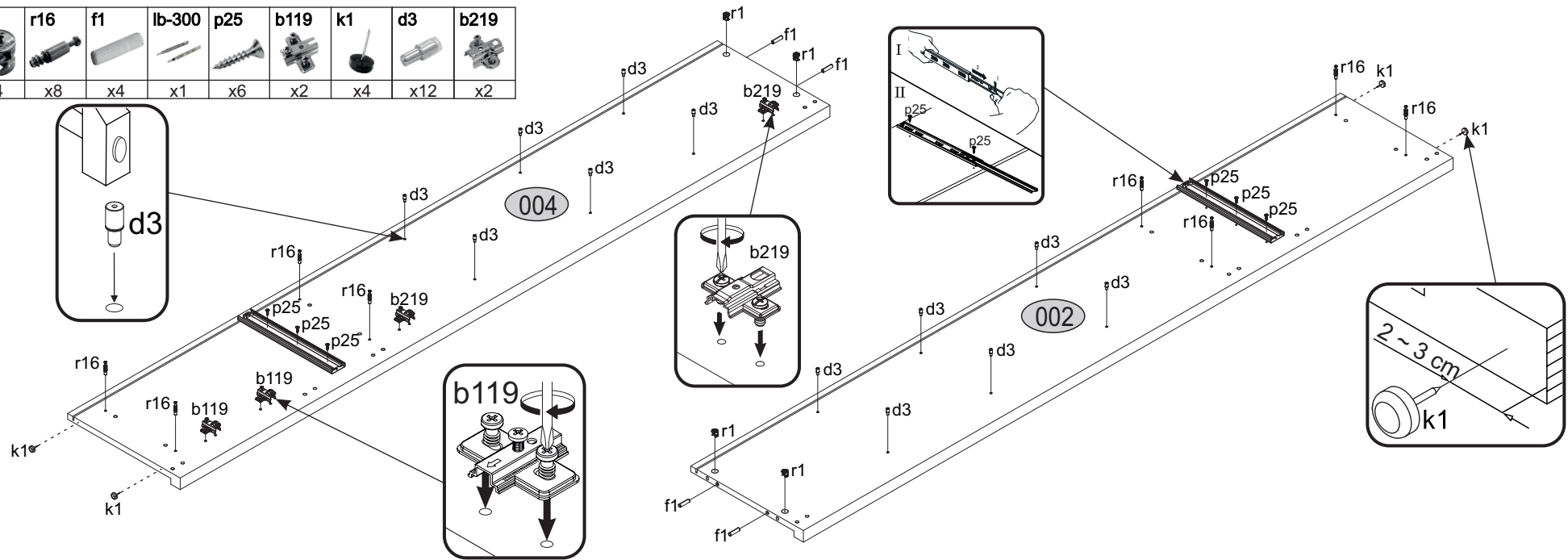

4

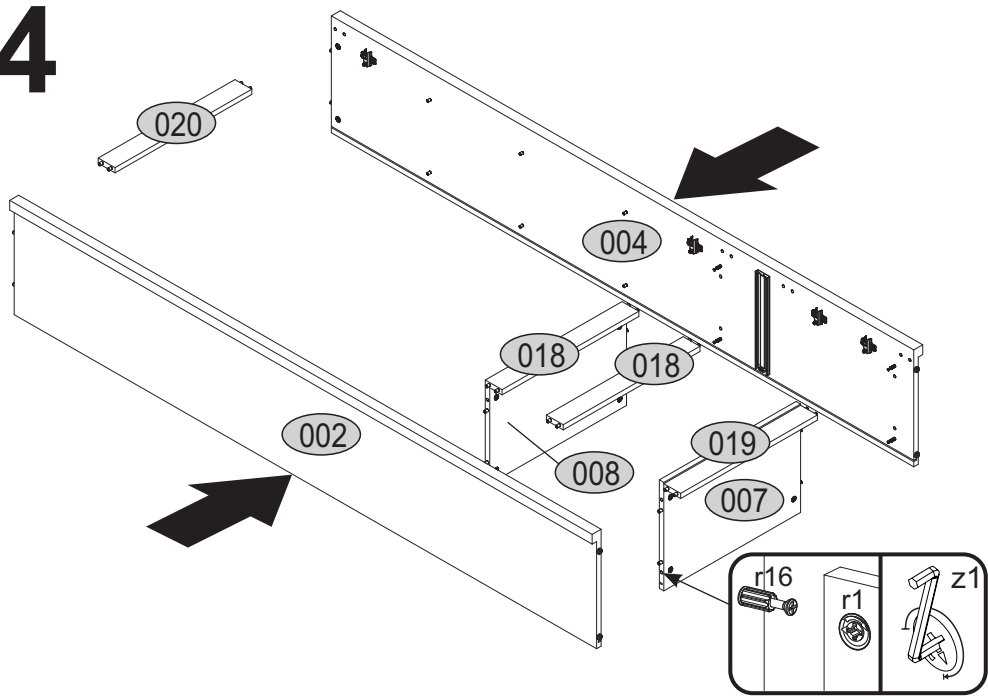

5

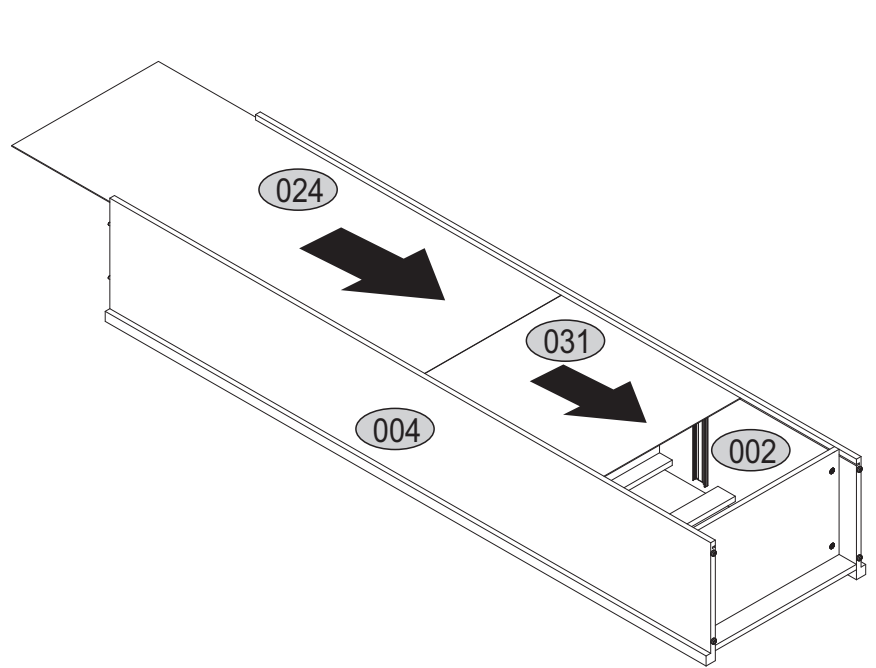

6

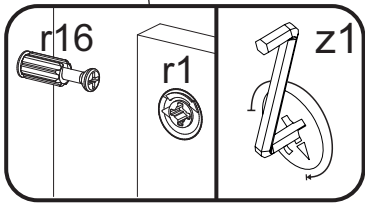
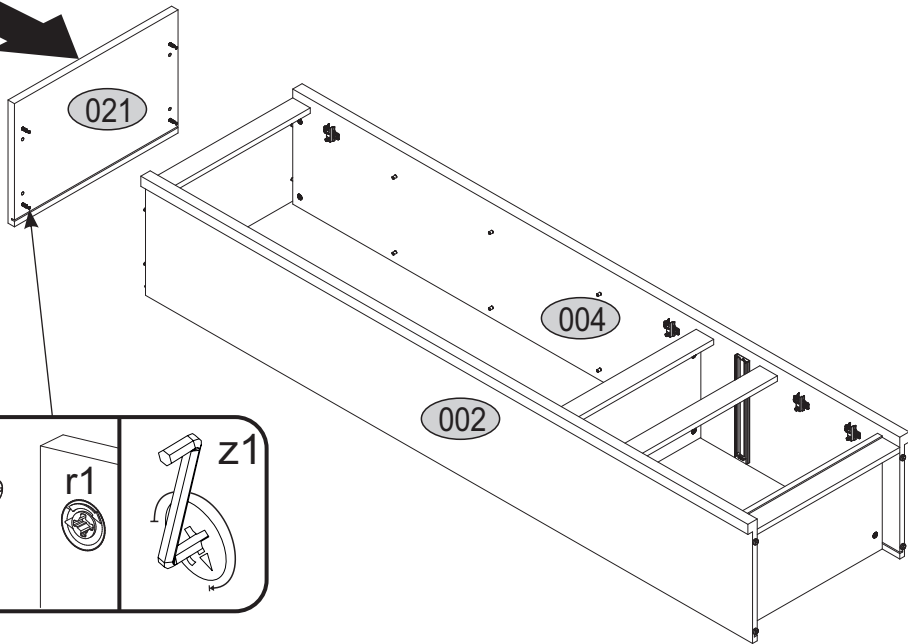

7

l2	p25	n260.01
x14	x16	x2

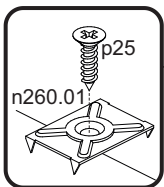
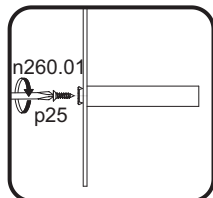
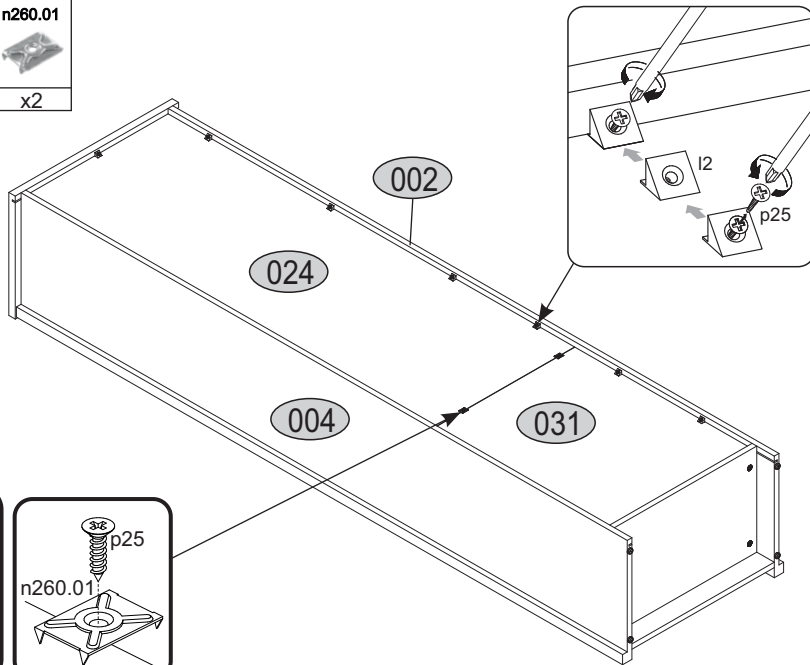

8

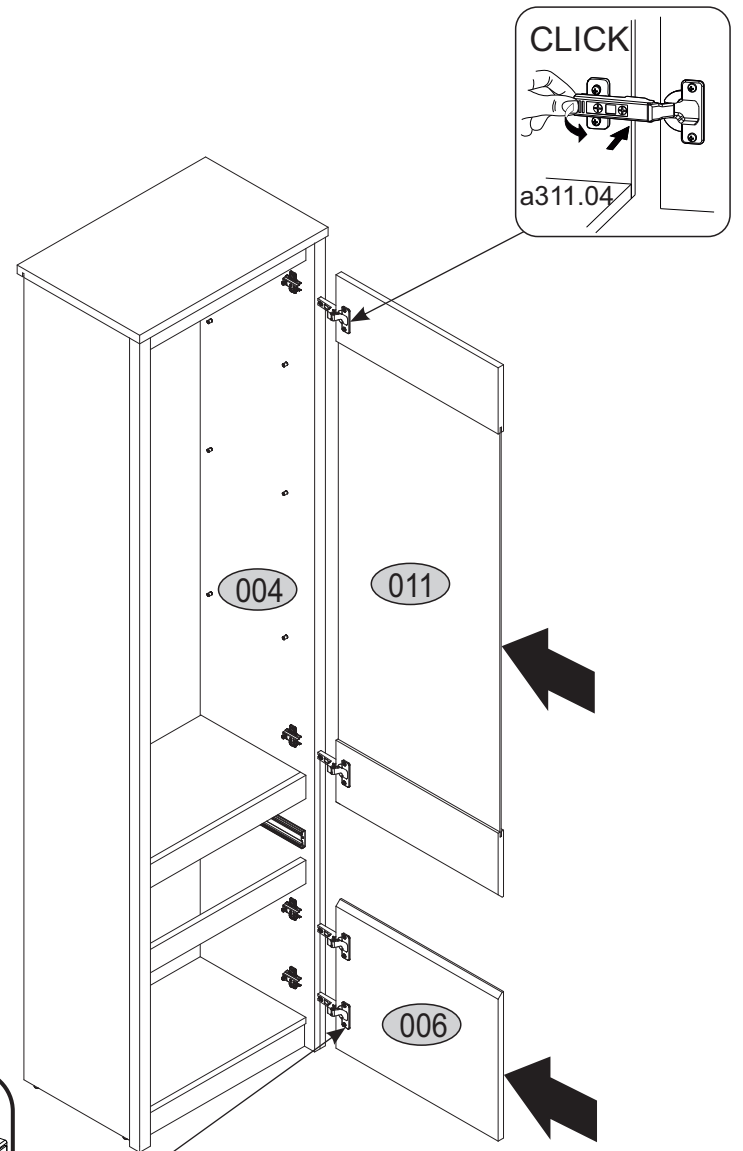
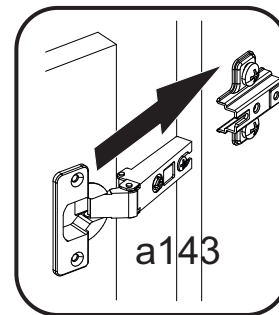
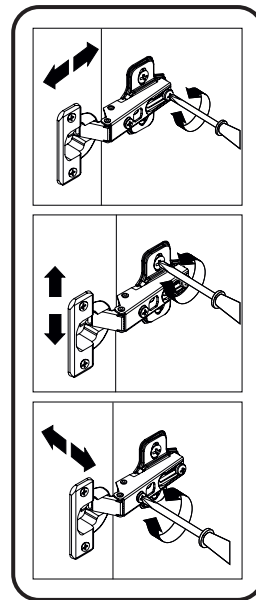

9

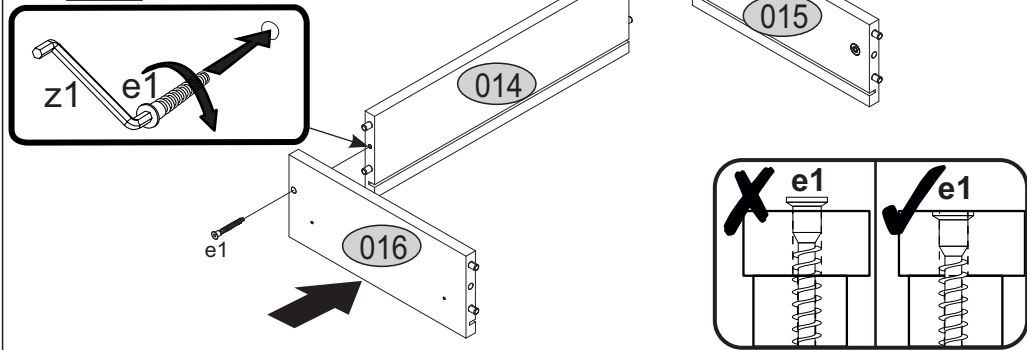

10

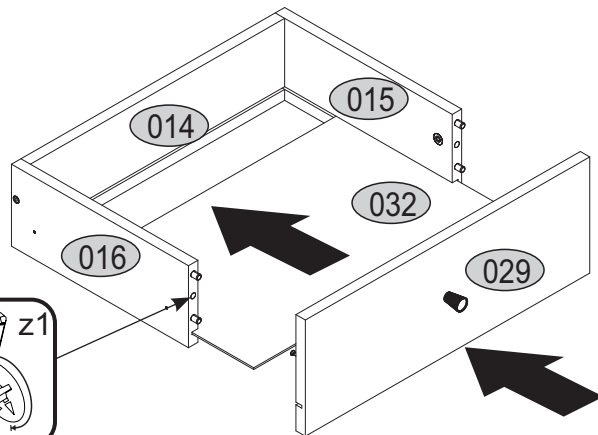
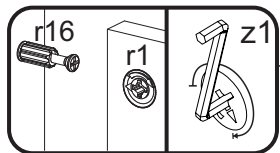

11

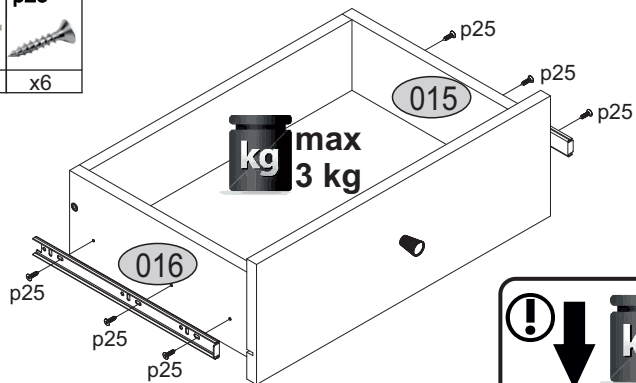
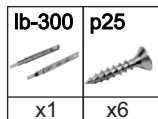

12

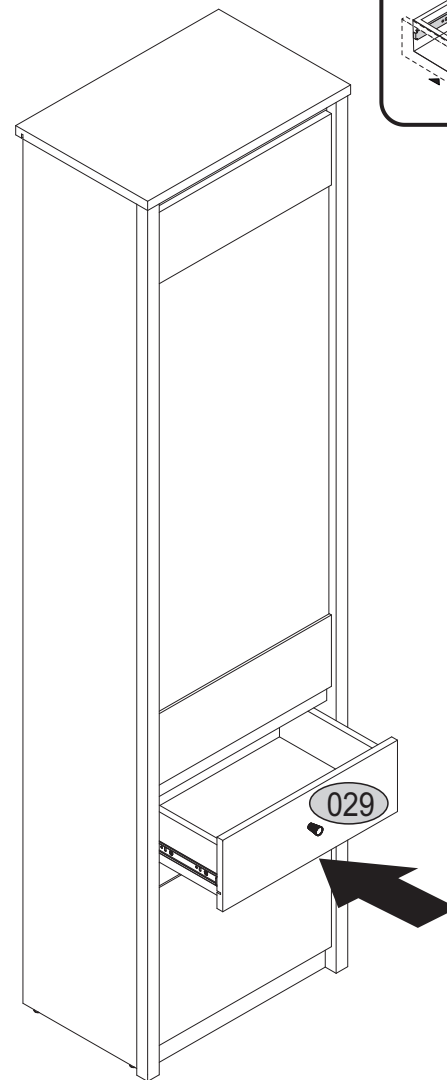
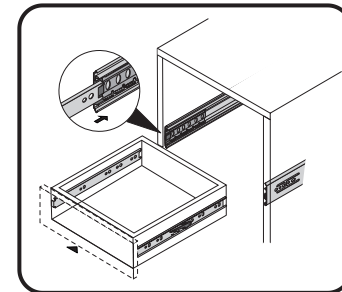

13

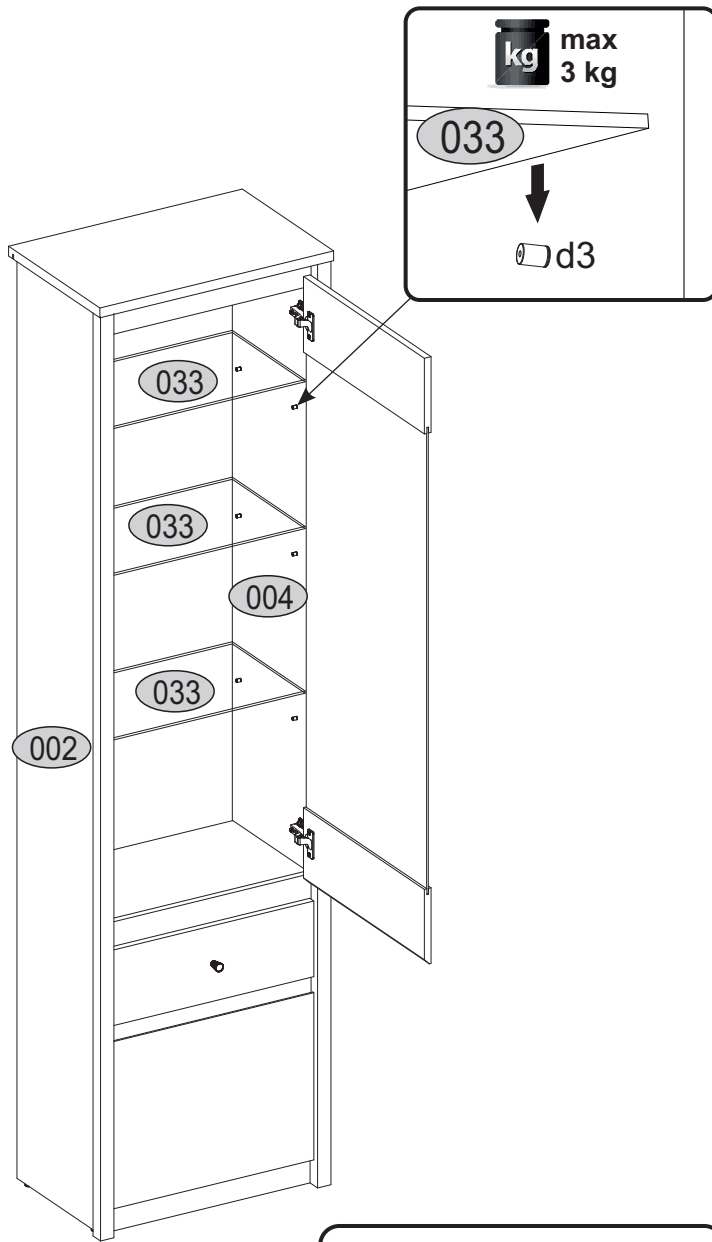

14

s2	p17	f3	n14	p25
x6	x1	x1	x1	x2

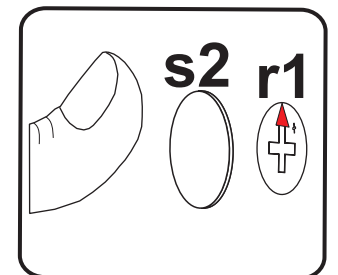
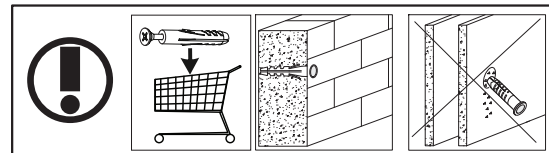
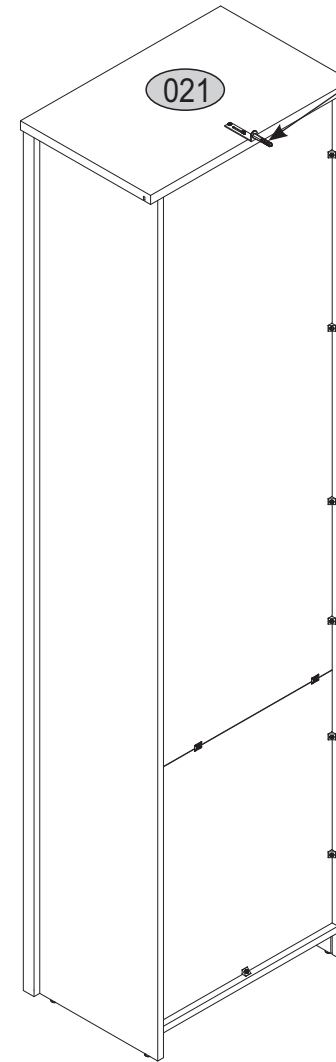
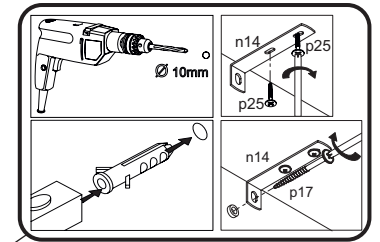

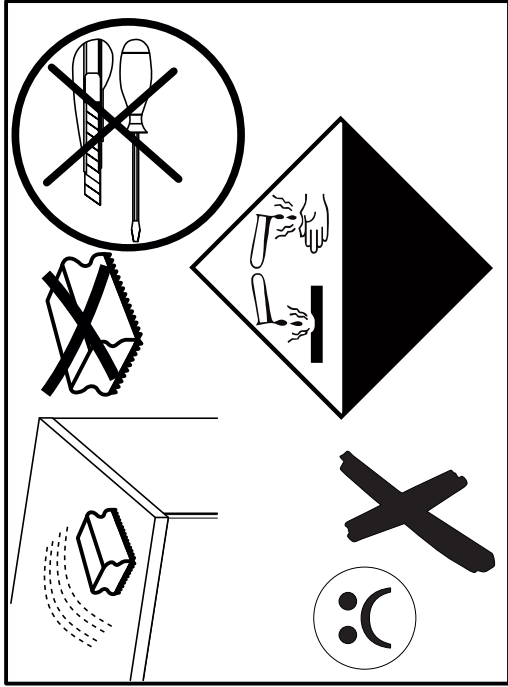
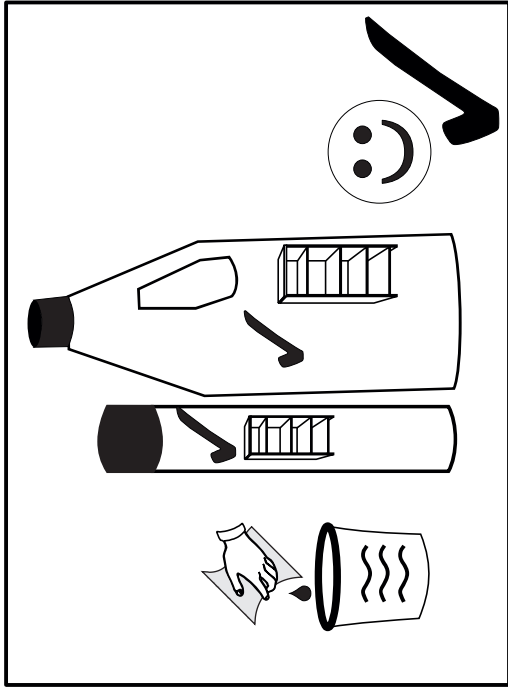
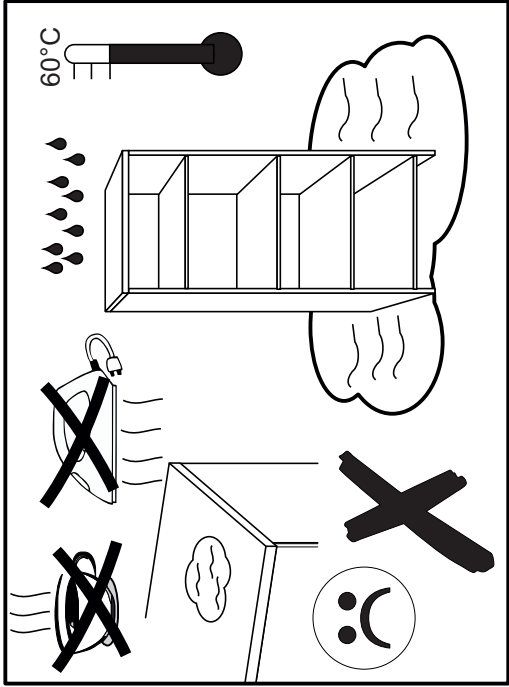
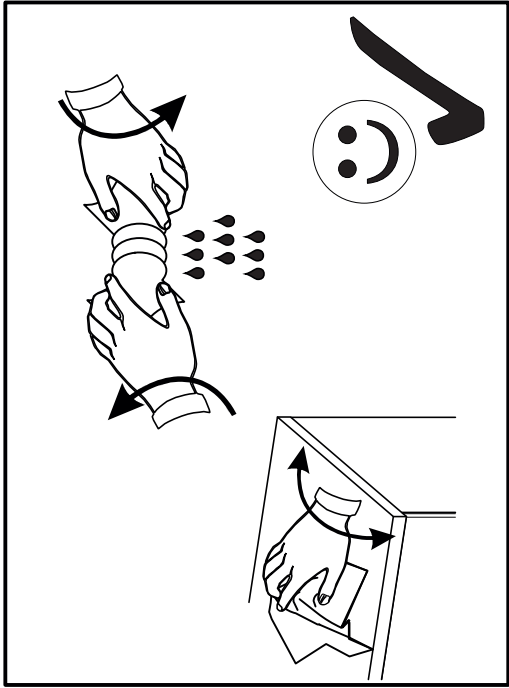
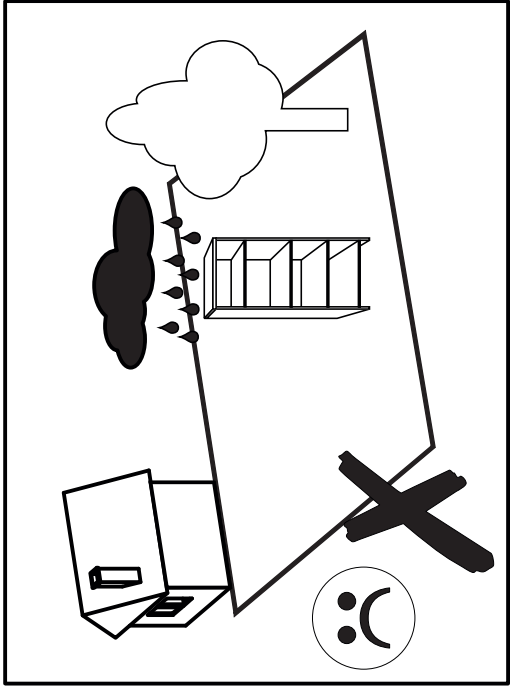
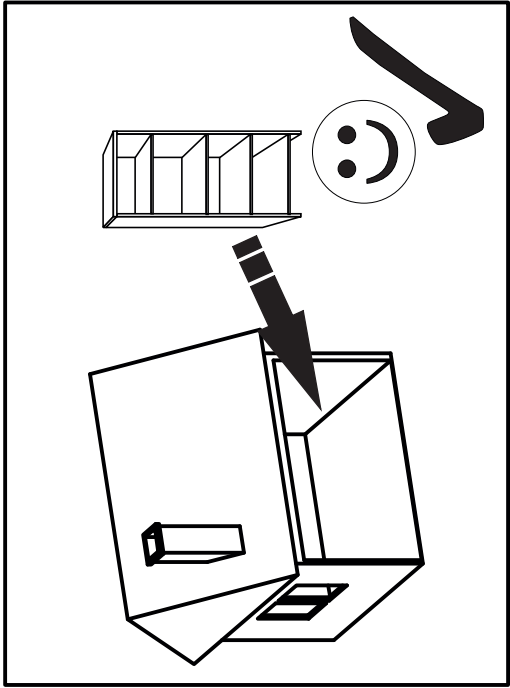
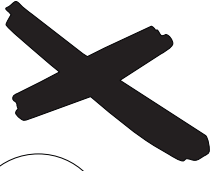
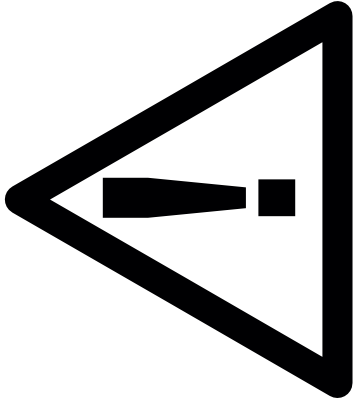

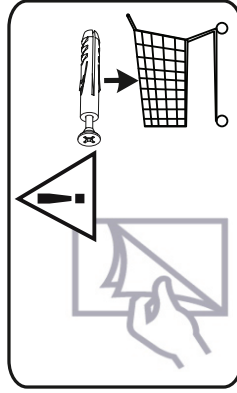
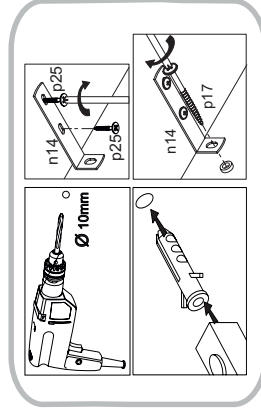
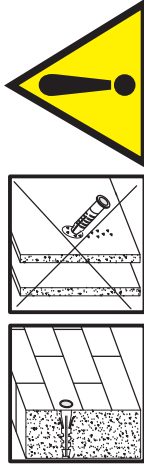

UA

Примітка. Ці меблі необхідно завжди прикріплювати до стіни, щоб уникнути ризиків, пов'язаних з падінням меблів. У пакеті немає кріпильних гвинтів, тому що тип кріплення повинен бути вибраний відповідно до типу стін. Виберіть, будь ласка, відповідні гвинти до вашої стіни

SK.

POZOR! Nábytok musí byť trvalo pripevnený k stene tak, aby sa zamedzilo riziku prevrátenia. Balík neobsahuje upevňovacie skrutky, pretože typ upevnenia je treba vybrať podľa typu steny. Vyberte typ vhodný pre Vašu stenu

FR.

ATTENTION! Ce meuble doit être fixé en permanence au mur pour éviter les risques de chute. Les vis de fixation ne sont pas livrées car le type de fixation doit être choisi en fonction du type de mur. Sélectionnez les fixations adaptées au mur.

HU.

FIGYELEM! Rögzítse a bútorkat a falhoz, hogy elkerülje a bútór felborulásának kockázatát. A készlemben nem található a rögzítőcsavarok, mivel a rögzítés típusa a fal típusától függ. Válassza ki a fal típusának megfelelő kötőelemeket

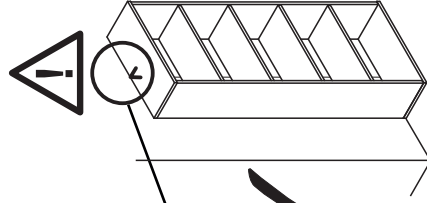

HR.

NAPOMENAI Namještaj mora biti trajno pričvršćen za zid, kako bi se izbjegao rizik od njegova prevrtanja. U paketu nema vijaka za pričvršćivanje, jer se vrsta montaže mora prilagoditi vrsti zida. Odaberite pravu vrstu prema Vašoj vrsti zida

E.

¡ATENCIÓN! El mueble debe ser fijado permanentemente a la pared para evitar el riesgo relacionado con el vuelco del mueble. En el paquete no hay tornillos de fijación, ya que se debe elegir el tipo de fijación adecuado para el tipo de pared. Elija el apropiado para su tipo de pared

PL.

UWAGA! Mebel należy trwale zamocować do ściany, aby uniknąć ryzyka związanego z przewróceniem się mebla. W paczce nie ma śrub mocujących, ponieważ rodzaj mocowania należy odpowiednio dobrać do rodzaju ściany. Dobierz właściwie do Twojego rodzaju ściany.

SLO.

POZOR! Pohištvo trajno pritrdite na steno, da preprečite tveganje, da se prevrne. V paketu ni pritrdilnih vijakov, saj je treba način pritrditve ustrezno izbrati glede na vrsto stene. Izberite način, ki je ustrezen za vašo steno.

CZ.

POZOR! Nábytek je nutné pevně připevnit ke zdi, abychom se vyhnuli riziku spojenému s jeho převrnutím. Součástí balení nejsou připevňovací šrouby, protože způsob připevnění je nutné zvolit podle druhu stěny. Vyberte správný pro Váš typ stěny

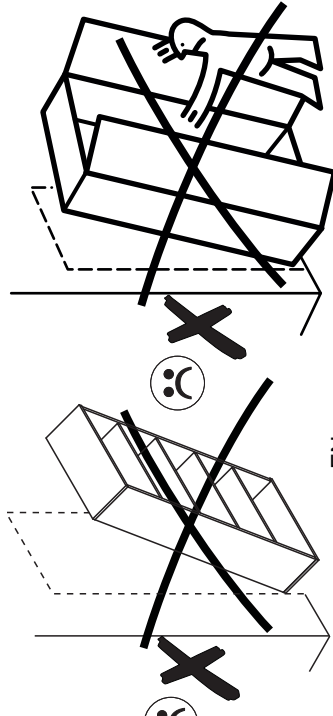

EN.

WARNING! To prevent overturning furniture from fix it to the wall permanently. Fixing devices are not included since different types wall, require different types of fixing devices. Please make sure you chose the correct ones for your type of wall

D.

ACHTUNG! Um alle mit dem Umkippen des Möbels verbundenen Risiken auszuschließen, muss das Möbel fest an der Wand verankert werden. Beschläge für die Wandbefestigung sind nicht beige packt, da diese von der jeweiligen Wandbeschaffenheit abhängig sind. Bitte solche Befestigungsschläge wählen, die für die heimischen Wände geeignet sind

GRE.

ΠΡΟΕΙΔΟΠΟΙΗΣΗ! Για αποφυγή απυξήματος στερεώστε το έπιπλο στον τοίχο μόνιμα. Τα εξαρτήματα τοποθέτησης δεν περιλαμβάνονται καθώς για κάθε τοίχο απαιτούνται διαφορετικά εξαρτήματα. Παρακαλώ βεβαιωθείτε ότι έχετε επιλέξει τα κατάλληλα για τον δικό σας τοίχο αξεστήματα

I.

ATTENZIONE! Il mobile deve essere permanentemente fissato alla parete per evitare i rischi derivanti da un ribaltamento del mobile. La confezione non include le viti di fissaggio, in quanto il tipo di fissaggio deve essere scelto in base al tipo di parete. Utilizzare viti appropriate in base al materiale della parete.