

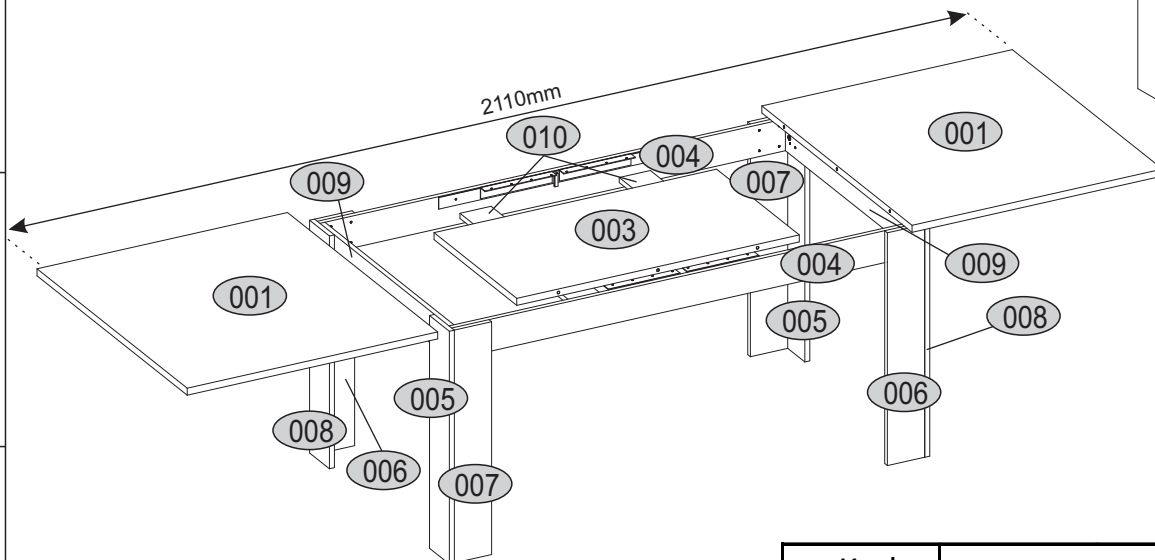

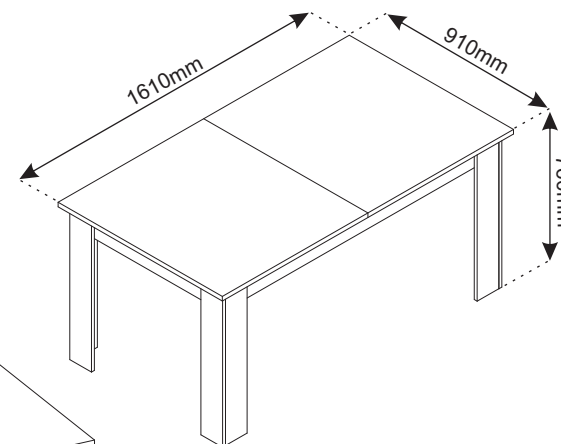

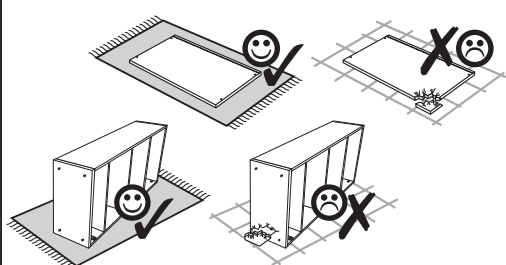

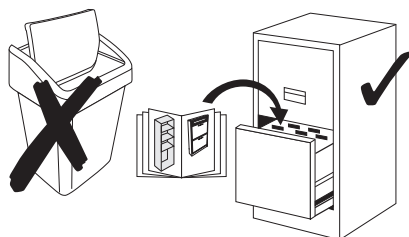

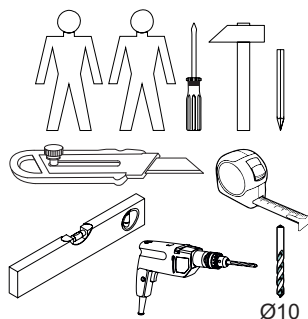
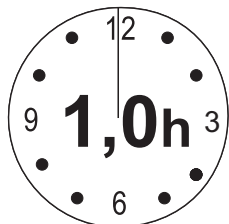





Instrukcja montażowa

KARIN Stół rozkładany 160



Kod	Wymiary				Pakiet
	805	908	22	2	
001	805	908	22	2	1/2
003	500	908	22	1	1/2
004	1512	100	16	2	2/2
005	729	120	16	2	1/2
006	729	120	16	2	1/2
007	729	120	16	2	1/2
008	729	120	16	2	1/2
009	780	100	16	2	2/2
010	780	100	16	2	2/2
Akcesoria				1	1/2

Aksesoria:

28x f1 Ø8x30 	20x r1 15x12 	20x r16 Ø5x24 	8x k1 
12x s2 	1x z1 	32x p21 Ø4x30 	2x l-750 
6x f5/3 	6x f5/4 	16x e2 	8x e3 

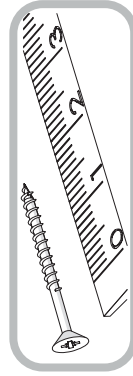

- 1**
- | | | | | | | | |
|-----|-----|------|------|-----|----|-------|----|
| r1 | f1 | f5/3 | f5/4 | r16 | k1 | l-750 | e3 |
| x20 | x28 | x3 | x3 | x20 | x4 | x2 | x4 |

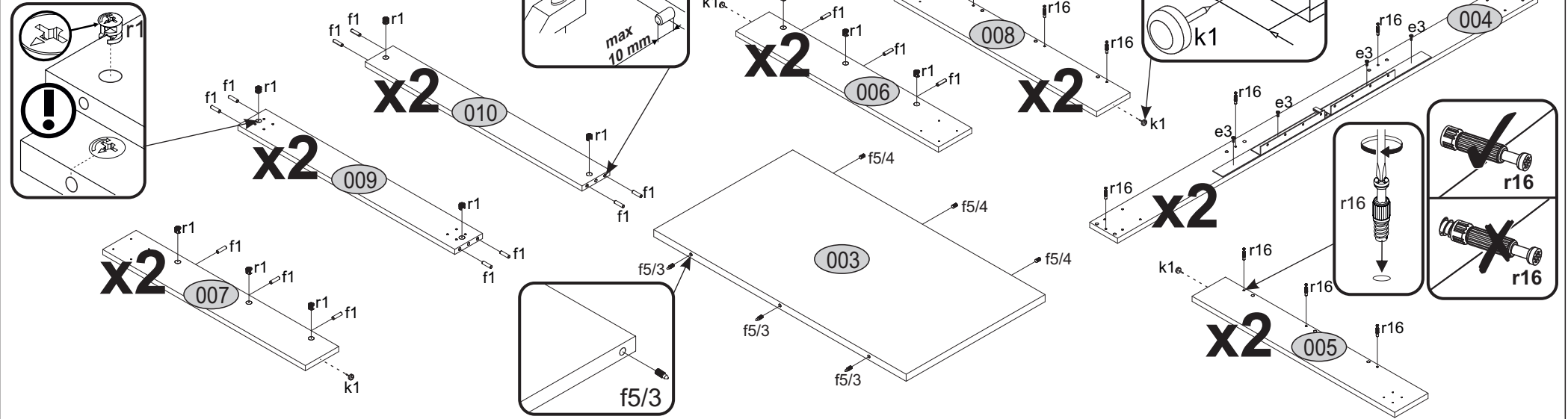
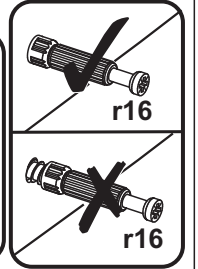
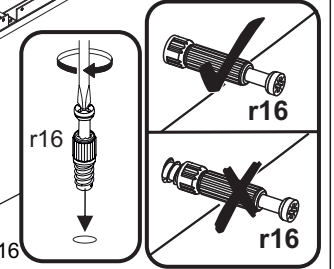
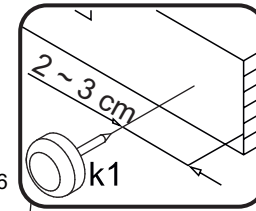
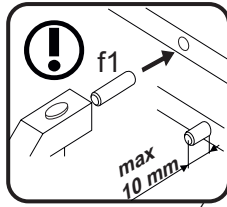
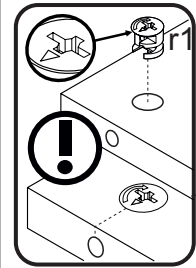

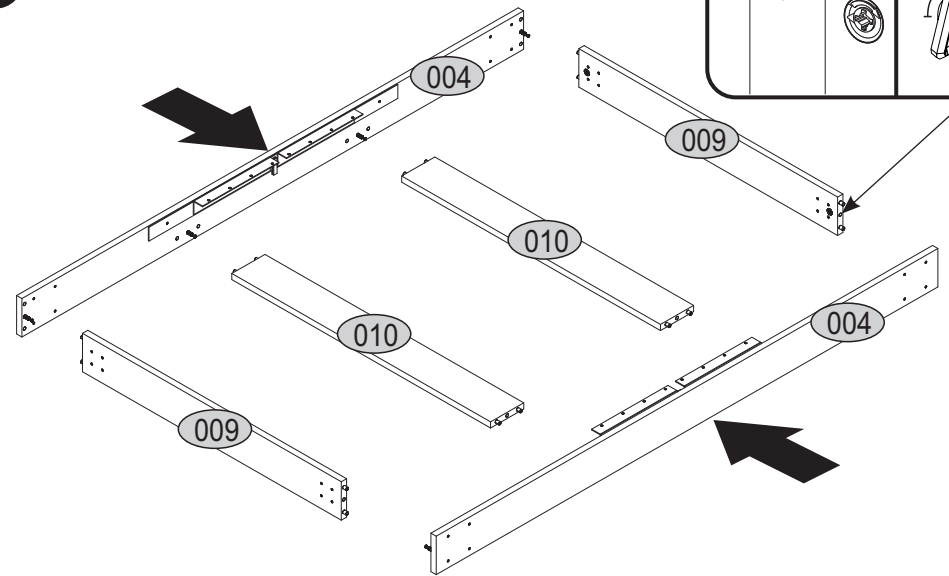
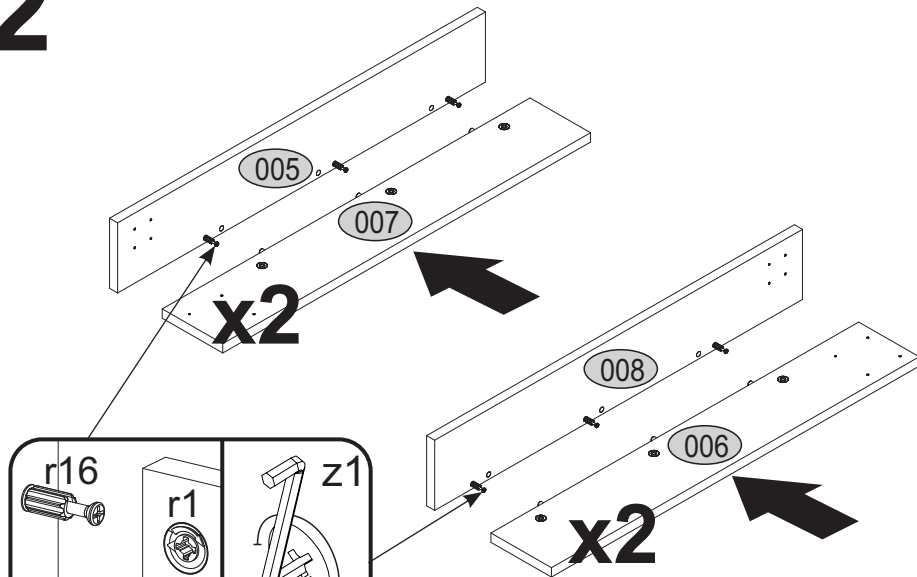
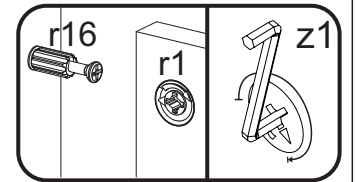
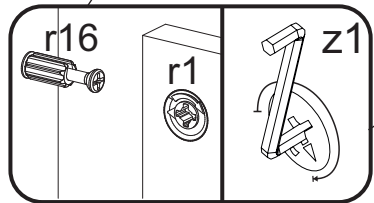

2

3



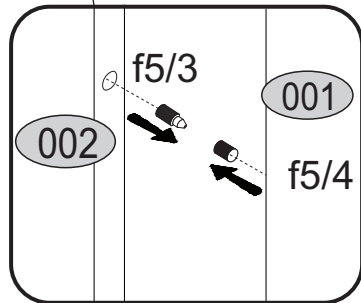
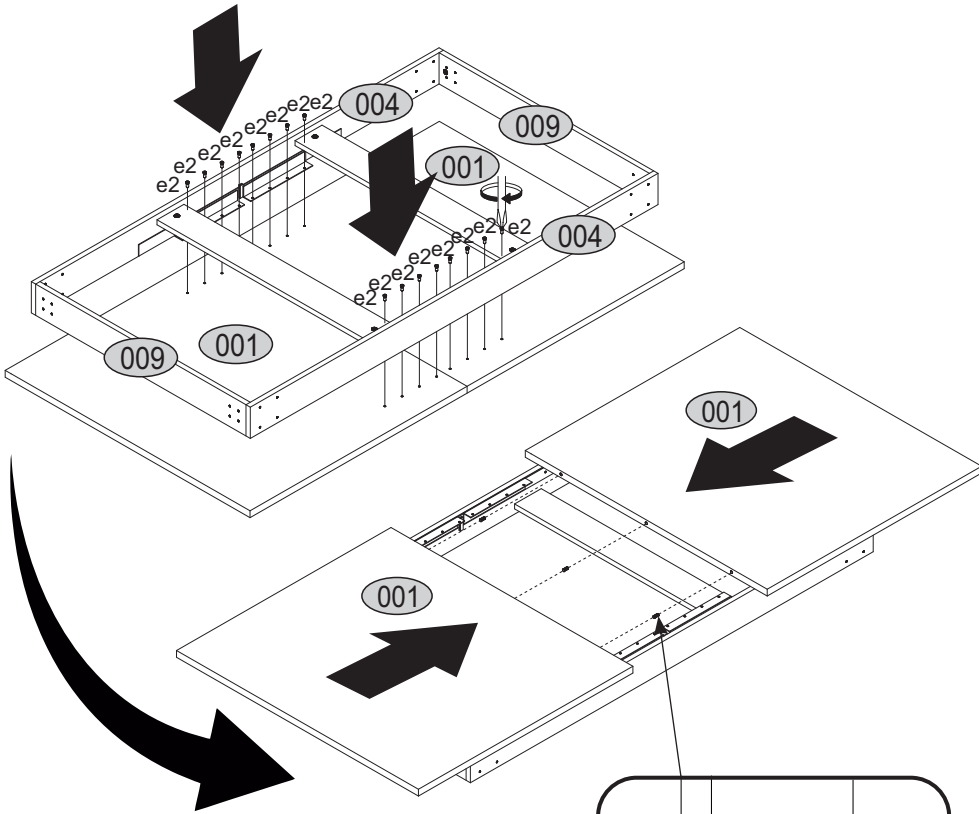

4

f5/3 	f5/4 	e2 
x3	x3	x16



5

p21 	s2 
x32	x12

